

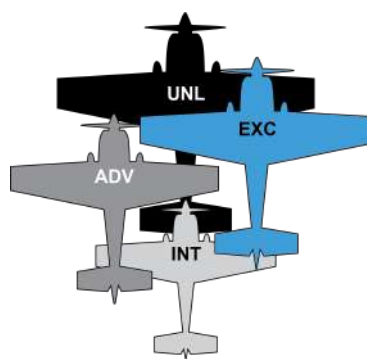

3 2 N D
**FAI WORLD AEROBATIC
CHAMPIONSHIPS**
MOKRE/ZAMOSC (EPZA), POLAND

And

1ST
**OPEN EXCELLENCE
AEROBATIC CHALLENGE**



15TH - 25TH AUGUST 2024
BULLETIN N° 1 - REV. 5
WAC 2024-1



THE AERO CLUB OF ZAMOSC



THE AERO CLUB OF POLAND



FEDERATION AERONAUTIQUE
INTERNATIONALE

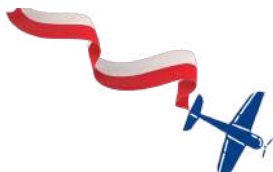

32ND FAI WORLD AEROBATIC CHAMPIONSHIPS
1ST OPEN EXCELLENCE AEROBATIC CHALLENGE
15TH - 25TH AUGUST 2024
ZAMOSC - POLAND

BULLETIN
WAC 2024-1
Rev. 5
8th April 2024

TABLE OF CONTENTS

TABLE OF CONTENTS	2
GENERAL	3
Organiser	3
Programmes	3
<i>Unlimited Cat I</i>	3
<i>Excellence Challenge</i>	3
REGULATIONS	3
<i>Unlimited</i>	3
<i>Excellence</i>	3
OFFICIAL LANGUAGE	3
WAC 2024 – TIMETABLE	4
Schedule and Important Dates	4
TRAINING ORGANISATION	5
FREE KNOWN SEQUENCES SUBMISSION	5
IMPORTANT CONTACTS	6
FEES AND PAYMENT DETAILS	6
Entry Fees	6
<i>Unlimited</i>	6
<i>Excellence</i>	6
Organiser's Bank Details	6
Entry Fee Payment and Deadlines	7
Other Fees	7
FUEL AND OIL POLICY	7
Fuel	7
Oil	7
PROTESTS	7
OFFICIALS	7
International Jury	7
Board of Judges	7
TEAM COMPOSITIONS	7
Competitors	7
Team Members	8
Observers	8
PARTICIPATION, COMPETITORS AND AIRCRAFT	8
Participants	8
Competitors	8
Aircraft	8
ARRIVALS AND LOGISTICS	9
SAFETY	9
MOKRE / ZAMOSC AND CONTEST BOX	10
The City of Zamosc	10
The Box and the Aerodrome	11
ACCOMMODATION	12
Hotel Zamojski	12
DISTANCES FROM THE NEAREST AIRPORTS	13
APPENDICES	15
Notam	15
Free Known Unlimited Mandatory Set	16
Excellence - Knowns	17
32nd FAI WAC / 1st FAI OEAC Official Entry Form	22

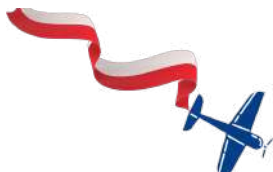

32ND FAI WORLD AEROBATIC CHAMPIONSHIPS
1ST OPEN EXCELLENCE AEROBATIC CHALLENGE
15TH - 25TH AUGUST 2024
ZAMOSC - POLAND

BULLETIN
WAC 2024-1
Rev. 5
8th April 2024

GENERAL

Organiser

The 32nd FAI World Aerobatic Championships and the 1st Open Excellence Aerobatic Challenge are organised by the Aero Club of Zamosc, the member of the Aero Club of Poland.

Programmes

Unlimited Cat I

The 32nd FAI World Aerobatic Championships are a Category I Event, open to Unlimited Pilots. The proper Titles and Medals will be awarded according to provision 6.5.5.1 of FAI Sporting Code, Section 6 Part 1.

Excellence Challenge

The 1st Open Excellence Aerobatic Challenge is opened to all Pilots with the appropriate level of training. The proper Titles of Winners of the Championships will be awarded with Medals provided by the Organiser.

REGULATIONS

Unlimited Cat I

The 32nd FAI World Aerobatic Championships are organised in accordance with the following rules:

- FAI Sporting Code - General Section;
- FAI Sporting Code, Section 6 Part 1;
- Flight Rules published by the Civil Aviation Authorities of Poland;
- Local Regulations.

Excellence Challenge

The 1st Open Excellence Aerobatic Challenge is organised in accordance with the following rules:

- FAI Sporting Code - General Section;
- Sporting Code - Open Excellence Aerobatic Challenge;
- Flight Rules published by the Civil Aviation Authorities of Poland;
- Local Regulations.

OFFICIAL LANGUAGE

- The Official Language is English;
- The language of all channels of communication and Briefings is English.



32ND FAI WORLD AEROBATIC CHAMPIONSHIPS
1ST OPEN EXCELLENCE AEROBATIC CHALLENGE
15TH - 25TH AUGUST 2024
ZAMOSC - POLAND

BULLETIN
WAC 2024-1
Rev. 5
8th April 2024

WAC 2024 – TIMETABLE

Schedule and Important Dates

Preliminary Registration Form	30/04/2024
Final Registration Form	15/06/2024
Free Known Submission Deadline	10/08/2024
Official Training Days	11-14/08/2024
Registration On-site	14-15/08/2024 till 14.00 LT
General Briefing	14/08/2024 - 17.00 LT
Competition Flights	15-24/08/2024
Opening Ceremony	17/08/2024 - 18.00 LT
Final Freestyle/ Air Show	24/08/2024 -
Closing Ceremony & Farewell Party	24/08/2024 - 18.00 LT
Departures	From 25/08/2024

- The Opening Ceremony takes place in the Old Square of the City of Zamosc;
- The Closing Ceremony & Farewell Party take place in the Aero Club of Zamosc (EPZA), Mokre 115, 22-400 Zamosc;
- Official Working Hours of the Contest Office are from 08:00 LT to 16:00 LT. The Contest Office is located in the main office;
- The Contest Office is available for any Official Inquiries, information or Deposit of Claims/Protest concerning the Contest during the Contest's duration;
- The Schedule may be changed without notice due to technical and organisational reasons as well as the weather conditions;
- The Entry Form must be sent to the following email address:
wac2024@aeroklubzamosc.pl
- Registration should be considered as valid after the confirmation from the Organiser;
- Each of the Participants is required to complete the Entry Form prior to their arrival.
- The Form is available in the Appendix below and on the following Contest's Website:
www.wac2024.pl



32ND FAI WORLD AEROBATIC CHAMPIONSHIPS
1ST OPEN EXCELLENCE AEROBATIC CHALLENGE
15TH - 25TH AUGUST 2024
ZAMOSC - POLAND

BULLETIN
WAC 2024-1
Rev. 5
8th April 2024

TRAINING ORGANISATION

- Official Training Flights at Mokre-Zamosc (EPZA) Airfield take place from 10th to 14th August 2024;
- The Competition Box shall be marked during the above mentioned official Training Days;
- Possibility of hangar space;
- According to the provisions of FAI Sporting Code, Section 6 Part 1, each Competitor is required to perform at least one Training Flight;
- Earlier Training Flights (unofficial) are possible with the previous agreement of the Organiser;

In case of any questions, please do not hesitate to contact the Organiser at: wac2024@aeroklubzamosc.pl or use the Contact Details specified below in this Bulletin.

FREE KNOWN SEQUENCES SUBMISSION

- The deadline for the Free Known submission is 10/08/2024;
- All the Competitors may submit their Free Known Sequences to the following email address: wiazanki@wp.pl
- Every submission will be confirmed;
- Sequence submissions are not valid without the confirmation;
- Each Competitor must submit a computer file of their Free Known sequence in OpenAero (.seq) format;
- The Competitor is responsible for the updated version of their software to comply with the Aresti System (ACRO) and FAI Sporting Code, Section 6 Part 1 regulations as currently amended by CIVA;
- Every file shall contain the following information (example only):

Pilot: Jan Nowak	Team: POL
Aircraft Type: EA330SC	Registration: SP-ABC (or TBA)
Class: Power	Rules: CIVA
Category: Unlimited	Programme: Programme 1
Positioning: 40	Date: 2024
Location: Mokre-Zamosc, POL	Filename: Jan_Nowak_FK_WAC2024

Hard copies, hand drawings, PDF files or OpenAero sequence links will not be accepted as the correct sequence submission.

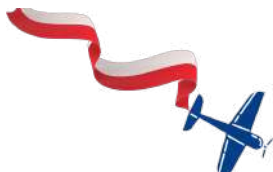

32ND FAI WORLD AEROBATIC CHAMPIONSHIPS
1ST OPEN EXCELLENCE AEROBATIC CHALLENGE
15TH - 25TH AUGUST 2024
ZAMOSC - POLAND

BULLETIN
WAC 2024-1
Rev. 5
8th April 2024

IMPORTANT CONTACTS

For more information concerning the 32nd FAI World Aerobatic Championships please use the following email addresses or phone numbers:

Function	Name	Cell	email
General Director	Mateusz Nowak	+48 790 873 390	wac2024@aeroklubzamosc.pl dyrektor@aeroklubzamosc.pl
Contest Director	Jerzy Makula	+48 536 364 107	jurekmakula@gmail.com
CD's Assistant	Pavel Kavka	+421 905 346 759	palo.kavka@gmail.com
President of the Jury	Pierre Varloteaux	+33 614 491 838	pierre.varloteaux@gmail.com

FEES AND PAYMENT DETAILS

Entry Fees

Unlimited Cat I

- EUR 3250,00 - Competitor;
- EUR 2250,00 - Team Member.

Excellence Challenge

- EUR 3000,00 - Competitor;
- EUR 2000,00 - Team Member.

The Entry Fee covers for both classes:

- Accommodation and meals during the Championships;
- Fuel and oil for the Competition Flights;
- Programme arranged by the Organiser;
- CIVA Sanction Fee: CHF 300,00.

Organiser's Bank Details

Bank Name: PKO BP
IBAN: PL 32 1020 5356 0000 1102 0216 8292
SWIFT (BIC Code): BPKOPLPW
Account Owner: Aeroklub Ziemi Zamojskiej, Mokre 115, 22-400 Zamosc



32ND FAI WORLD AEROBATIC CHAMPIONSHIPS
1ST OPEN EXCELLENCE AEROBATIC CHALLENGE
15TH - 25TH AUGUST 2024
ZAMOSC - POLAND

BULLETIN
WAC 2024-1
Rev. 5
8th April 2024

Entry Fee Payment and Deadlines

- The Entry Fee payment deadline is 30/06/2024;
- If the payment is made later than 30/06/2024, an additional EUR 100,00 will be charged and plus EUR 150,00 after 15/07/2024.

Other Fees

- Hangar space before the Training Days: EUR 30,00/day;
- Fuel before the Contest Days.

FUEL AND OIL POLICY

Fuel

- Avgas: 100LL;
- Price: The information shall be provided in Bulletin N° 2 (WAC 2024-2)

Oil

- The oil is available in the Hangar - Please precise the type of oil needed in the Registration Form;
- Price: The information shall be provided in Bulletin N° 2 (WAC 2024-2)

PROTESTS

- Protests should be submitted to the Contest Office;
- Each Protest must be submitted accompanied with the payment of EUR 90,00.

OFFICIALS

International Jury

- President: Pierre Varloteaux;
- Members: Steve Todd, Edward Waasdorp.

Board of Judges

- Chief Judge: Quintin Hawthorne;
- The complete Board of Judges will be announced in the next Bulletin (WAC2024-2).

TEAM COMPOSITIONS

Competitors

- The Entries for the Competitors are accepted from National Airport Controls according to provision 1.2.6 of FAI Sporting Code, Section 6 Part 1.



32ND FAI WORLD AEROBATIC CHAMPIONSHIPS
1ST OPEN EXCELLENCE AEROBATIC CHALLENGE
15TH - 25TH AUGUST 2024
ZAMOSC - POLAND

BULLETIN
WAC 2024-1
Rev. 5
8th April 2024

| Team Members

- The Team of each FAI NAC may include the following Officials: Team Managers, Coaches, Doctors, Interpreters, Mechanics etc.

| Observers

- The Relatives of Competitors are accepted as Observers of the National Teams;
- The Entry Fee for Observers is the same as for the regular Team Members.

| PARTICIPATION, COMPETITORS AND AIRCRAFT

| Participants

- All Members of FAI NACs may be represented at the WAC 2024 via their Teams and/or an individual Competitor/Observer;
- Entries (including H/C pilots) may be submitted by NACs authorised Representatives only, with the exception of FAI Applicants from countries without a NAC.

| Competitors

Each Competitor should be a holder of:

- A valid Pilot Licence with an aerobatic extension according to a given Competitor's national legislation;
- A valid FAI Sporting Licence;
- A valid Medical Certificate;
- A valid Personal Insurance Policy.

| Aircraft

- All participating Aircraft must satisfy the performance criteria essential for the Competition Flights in Unlimited and Excellence Challenge;
- For all competing Aircraft, a valid Certificate of Airworthiness of the related country must be presented;
- For all competing Aircraft using the airspace of the Republic of Poland, Liability Insurance must be concluded with respect to damage caused by operation of the Aircraft to third parties covering a minimum amount in SDR (Special Drawing Rights) or in equivalent;
- Value of any other freely convertible currencies, for the Aircraft with MTOW as mentioned below:
MTOW up to 1000 kg - SDR 1.500.000 (approx. EUR 1.800.000)
MTOW above 1000 kg to 2700 kg - 3.000.000 SDR (approx. EUR 3.600.000);
- Each competing Aircraft must be insured against 3rd Party Public Liability, according to EU Regulation (EC) No. 785/2004, claims with a minimum amount as mentioned above according to MTOW. Any person legally responsible for a given Aircraft arriving



32ND FAI WORLD AEROBATIC CHAMPIONSHIPS
1ST OPEN EXCELLENCE AEROBATIC CHALLENGE
15TH - 25TH AUGUST 2024
ZAMOSC - POLAND

BULLETIN
WAC 2024-1
Rev. 5
8th April 2024

to the Republic of Poland, must be able to present their Insurance Policy with a copy in English, certified by the Insurance Company;

- All competing Aircraft must be equipped with VHF radio channel separation of 8.33kHz according to Implementing Regulation (IR) 1079/2012 of the European Commission valid from 1st January 2018;
- In case of insufficient hangar capacity, the priority will be determined by the Organiser. In case of doubt, the order of received Entry Fee payment dates will be taken into account.

ARRIVALS AND LOGISTICS

- The Organiser requires the Participants to announce their expected arrival date to coordinate the Aerodrome operations and aircraft storage;
- The Organiser offers to arrange accommodation in hotels for the duration of the Championships and Training Days (if requested).

SAFETY

- Due to the war in Ukraine, some military activities may occur (see Notam in Appendix);
- The Organiser remains in close contact with the Polish Military Authorities that support the WAC in Zamosc and will facilitate the access to the Aerodrome;
- The Polish territory is a sovereign country, and Poland is a NATO Member;
- If for any reason the geopolitical situation is getting worse, the Organiser will immediately inform the NACs. Regular updates will be posted on the Contest's Website;
- For further information, please contact the President of the Jury.

Pierre Varloteaux

President of the International Jury - WAC 2024

+33 614 491 838

pierre.varloteaux@gmail.com

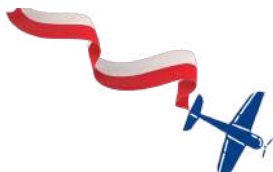

32ND FAI WORLD AEROBATIC CHAMPIONSHIPS
1ST OPEN EXCELLENCE AEROBATIC CHALLENGE
15TH - 25TH AUGUST 2024
ZAMOSC - POLAND

BULLETIN
WAC 2024-1
Rev. 5
8th April 2024

MOKRE / ZAMOSC AND CONTEST BOX

The City of Zamosc



Zamosc is a historical city in south-eastern Poland. It is situated in the southern part of Lublin Voivodeship, about 90 km from Lublin, 247 km from Warsaw. The Old Town and the remnants of the old Zamosc Fortress constitute an urban complex inscribed on the UNESCO World Heritage Site.

(Info source: en.m.wikipedia.org)





32ND FAI WORLD AEROBATIC CHAMPIONSHIPS
1ST OPEN EXCELLENCE AEROBATIC CHALLENGE
15TH - 25TH AUGUST 2024
ZAMOSC - POLAND

BULLETIN
WAC 2024-1
Rev. 5
8th April 2024

| The Box and the Aerodrome

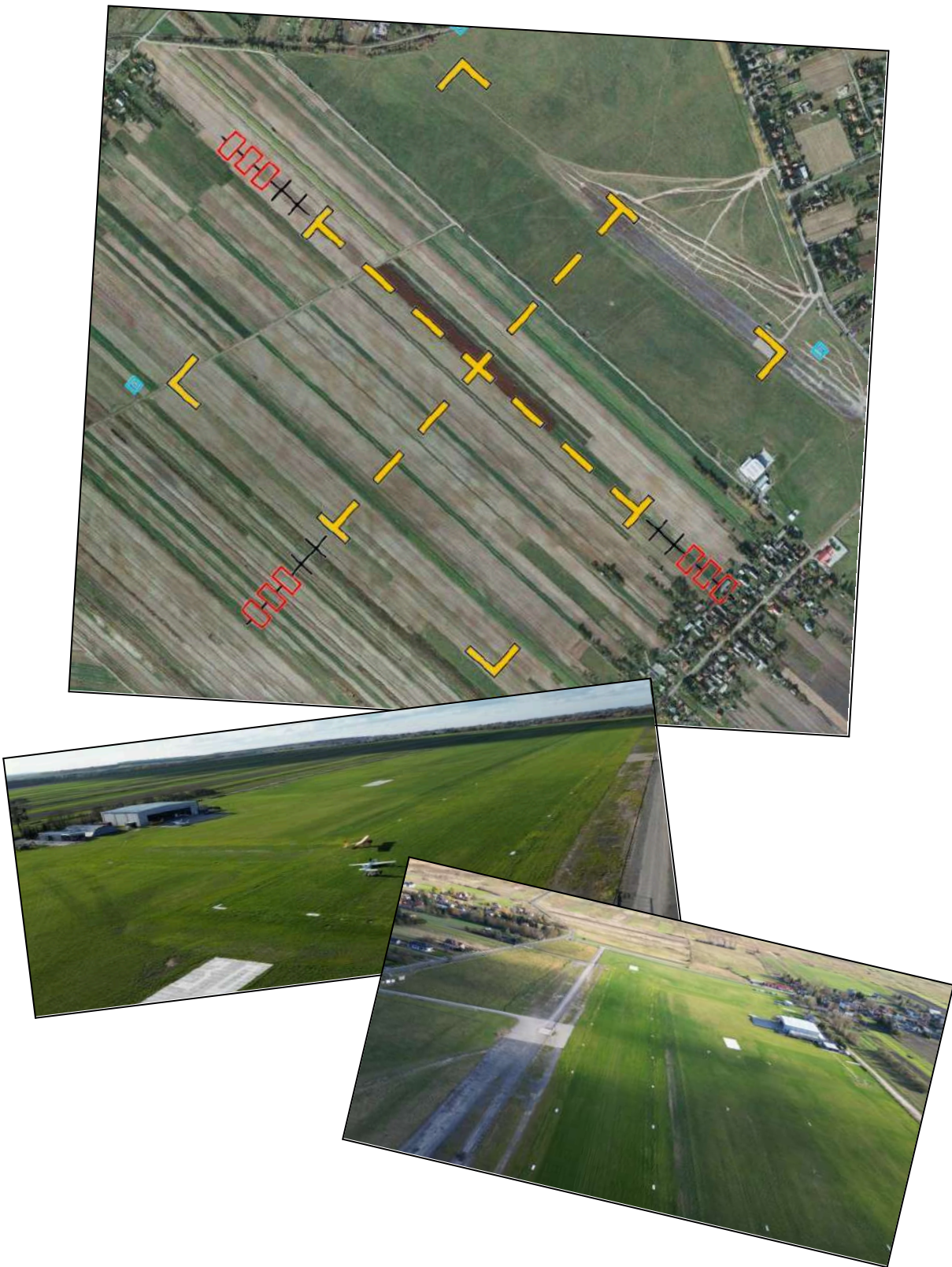



32ND FAI WORLD AEROBATIC CHAMPIONSHIPS
1ST OPEN EXCELLENCE AEROBATIC CHALLENGE
15TH - 25TH AUGUST 2024
ZAMOSC - POLAND

BULLETIN
WAC 2024-1
Rev. 5
8th April 2024

ACCOMMODATION

Hotel Zamojski

<http://www.hotelzamojski.pl/>

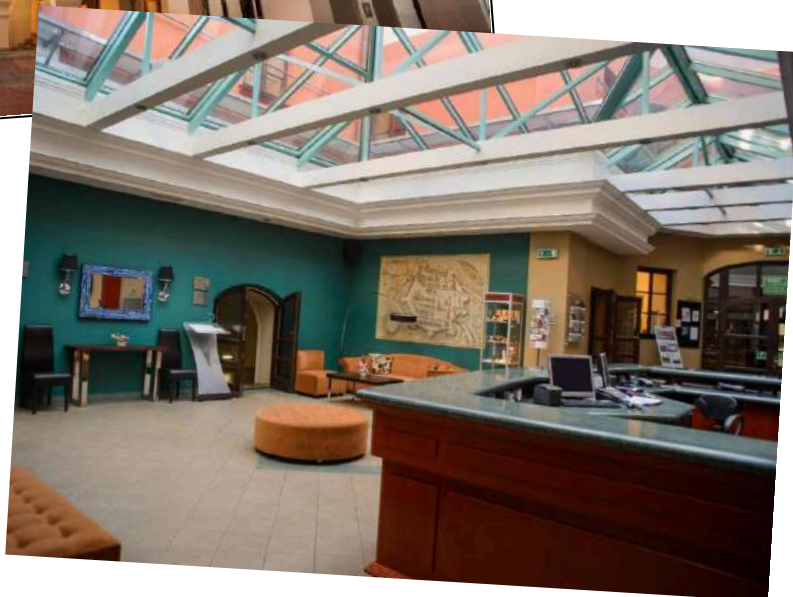
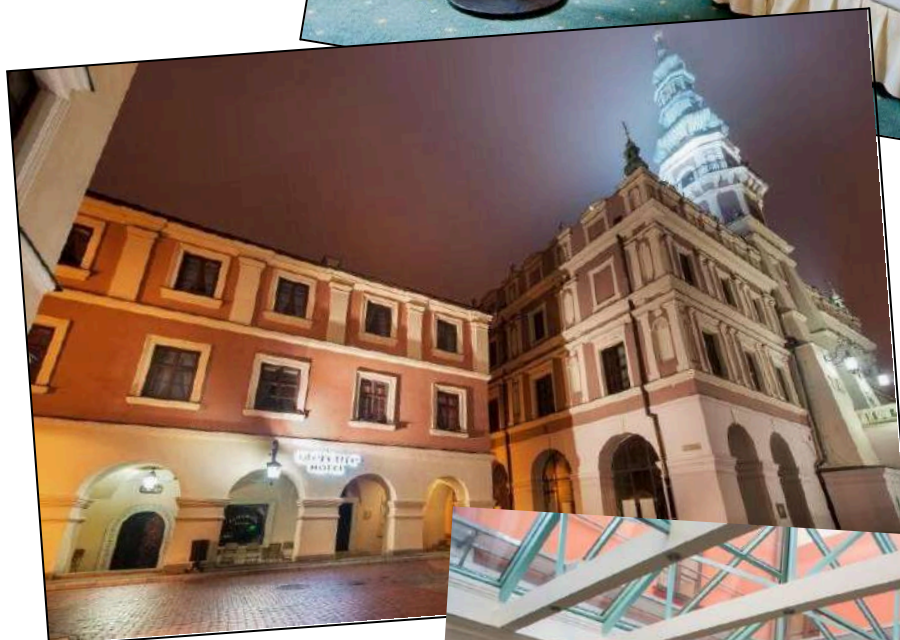



32ND FAI WORLD AEROBATIC CHAMPIONSHIPS
1ST OPEN EXCELLENCE AEROBATIC CHALLENGE
15TH - 25TH AUGUST 2024
ZAMOSC - POLAND

BULLETIN
WAC 2024-1
Rev. 5
8th April 2024

DISTANCES FROM THE NEAREST AIRPORTS

Rzeszow Jesionka – Zamosc

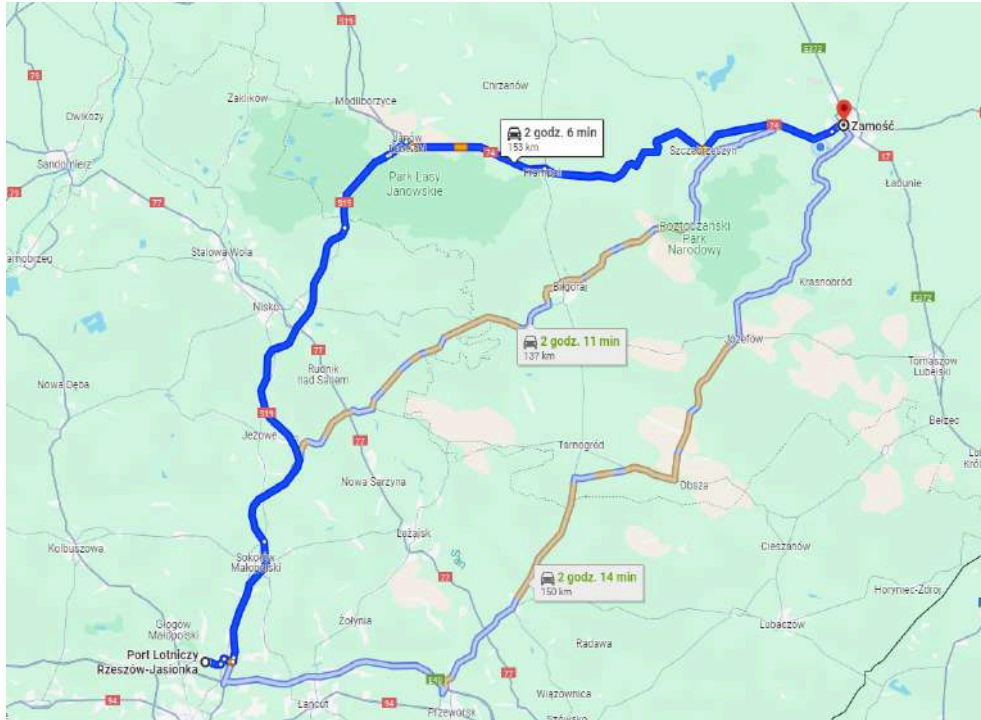

Warszawa Babice – Zamosc

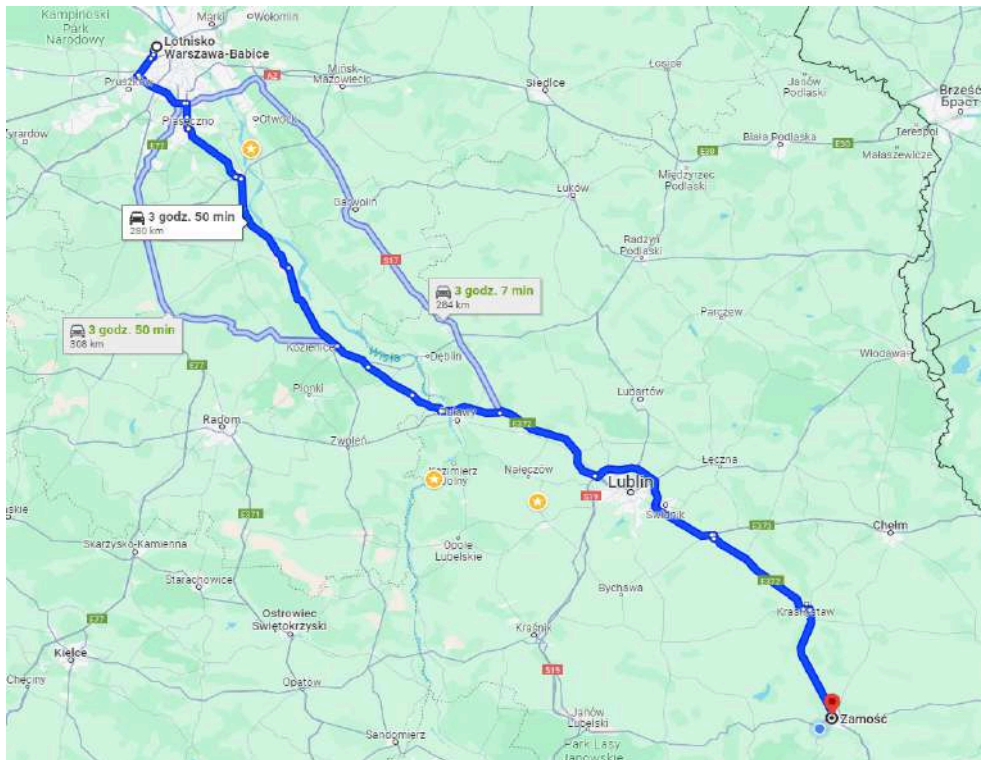

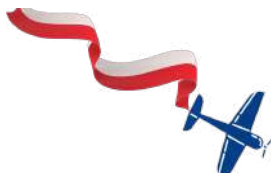

32ND FAI WORLD AEROBATIC CHAMPIONSHIPS
1ST OPEN EXCELLENCE AEROBATIC CHALLENGE
15TH - 25TH AUGUST 2024
ZAMOSC - POLAND

BULLETIN
WAC 2024-1
Rev. 5
8th April 2024

Krakow Balice – Zamosc

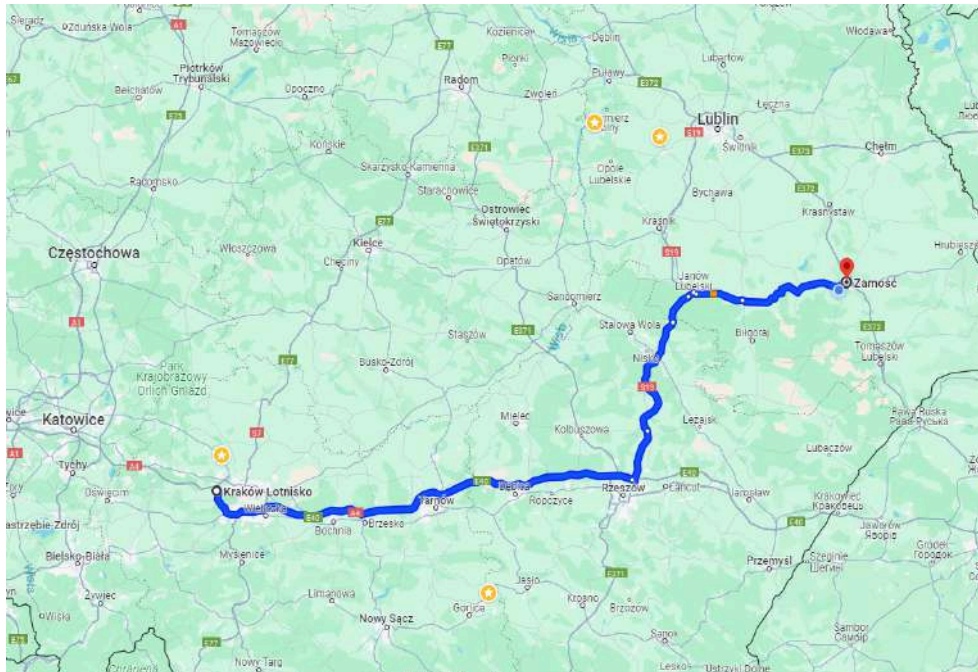

Lublin – Zamosc

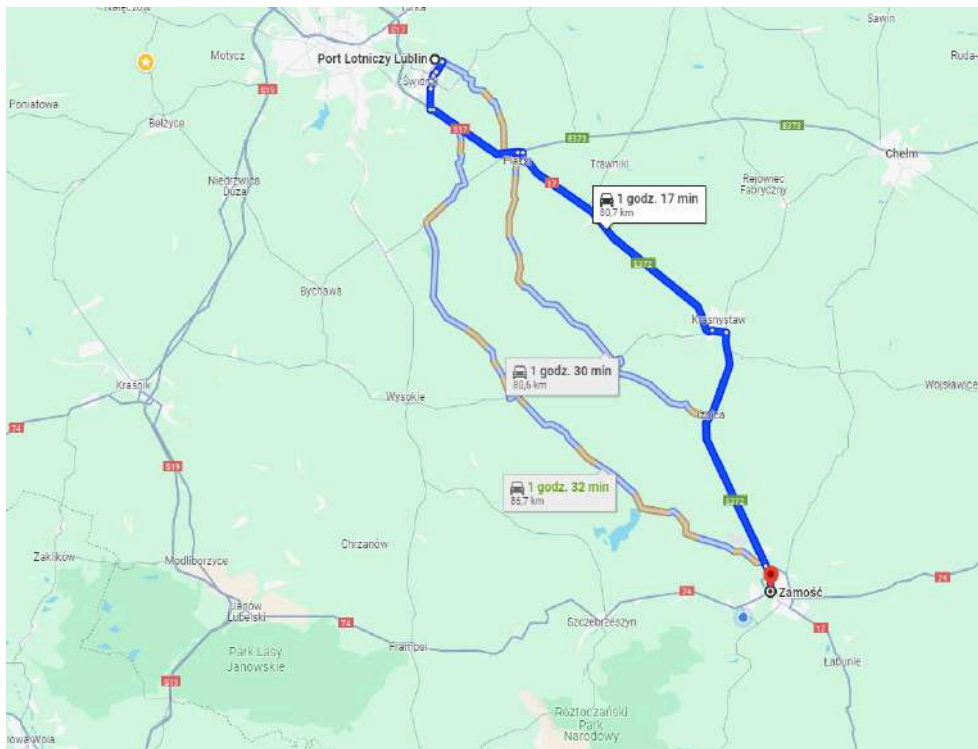

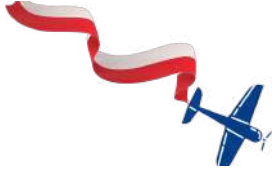

32ND FAI WORLD AEROBATIC CHAMPIONSHIPS
1ST OPEN EXCELLENCE AEROBATIC CHALLENGE

15TH - 25TH AUGUST 2024
ZAMOSC - POLAND

BULLETIN
WAC 2024-1
Rev. 5
8th April 2024

APPENDICES

Notam

N0608 /2024 N

Q) EPWW/QRMXX/IV/BO /W /000/095/5220N02216E210

A) EPWW B) 2402050600 C) 2405050600

E) NAV WRNG FOR AIRSPACE:

LATERAL LIMITS (WGS-84):

1. 550320N0184457E

2. 532856N0184613E

3. 522825N0193912E

4. 513316N0213143E

5. 504151N0214358E

6. 491941N0205255E

THEN ALONG THE STATE BORDER TO THE POINT:

1. 550320N0184457E

VERTICAL LIMITS: GND-FL95

UNPLANNED MILITARY ACTIVITY RELATED TO ENSURING STATE SECURITY CAN BE EXPECTED WITHIN THE AREA. IT IS RECOMMENDED THAT ACFT PERFORMING

FLIGHTS IN UNCONTROLLED CLASS G AIRSPACE PUBLISHED IN AIP POLAND IN FIS AREAS OF RESPONSIBILITY MAINTAIN AIR-GROUND AUDIO MONITORING ON PROPER FIS FREQ

ADDITIONALLY IT IS RECOMMENDED TO TURN ON SSR TRNSPONDER MODE A,C OR S.

F) GND

G) FL095





32ND FAI WORLD AEROBATIC CHAMPIONSHIPS
1ST OPEN EXCELLENCE AEROBATIC CHALLENGE

15TH - 25TH AUGUST 2024
ZAMOSC - POLAND

BULLETIN
WAC 2024-1
 Rev. 5
 8th April 2024

Free Known Unlimited Mandatory Set

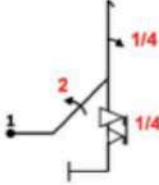
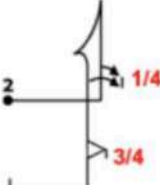
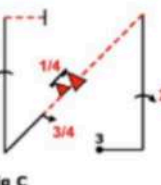
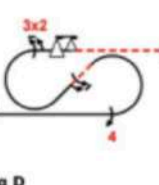
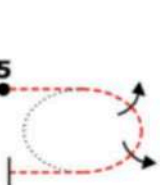
 <p>Fig A 5.3.1.1(18) 9.2.2.4(11) 9.1.1.1(6) 9.9.5.5(13) K: 48</p>	 <p>Fig B 6.2.1.1(15) 9.1.1.5(14) 9.9.5.3(11) K: 40</p>	 <p>Fig C 1.3.11.1(20) 9.2.1.4(13) 9.10.4.5(15) 9.1.4.3(6) 9.1.1.4(12) K: 66</p>	 <p>Fig D 7.5.2.1(15) 9.4.3.4(11) 9.1.4.6(10) 9.2.3.6(12) 9.9.3.6(14) K: 62</p>	 <p>Fig E 2.2.5.4(25) K: 25</p>
--	--	---	---	--



32ND FAI WORLD AEROBATIC CHAMPIONSHIPS
1ST OPEN EXCELLENCE AEROBATIC CHALLENGE
15TH - 25TH AUGUST 2024
ZAMOSC - POLAND

BULLETIN
WAC 2024-1
Rev. 5
8th April 2024

Excellence Challenge - Knowns

- The two Known Sequences are available on the Contest's Website with the following format:
 - pdf;
 - seq.
- The Programme to be flown during the Competition will be chosen by Drawing of Lots at the General Briefing;
- The Rules for the Open Excellence Aerobatic Challenge are available on the Contest's Website and on Civa News Website;
- Links:
<https://wac2024.pl/>
<https://www.civanews.com/>
<https://www.openaero.net/>





32ND FAI WORLD AEROBATIC CHAMPIONSHIPS
1ST OPEN EXCELLENCE AEROBATIC CHALLENGE
15TH - 25TH AUGUST 2024
ZAMOSC - POLAND

BULLETIN
WAC 2024-1
Rev. 5
8th April 2024

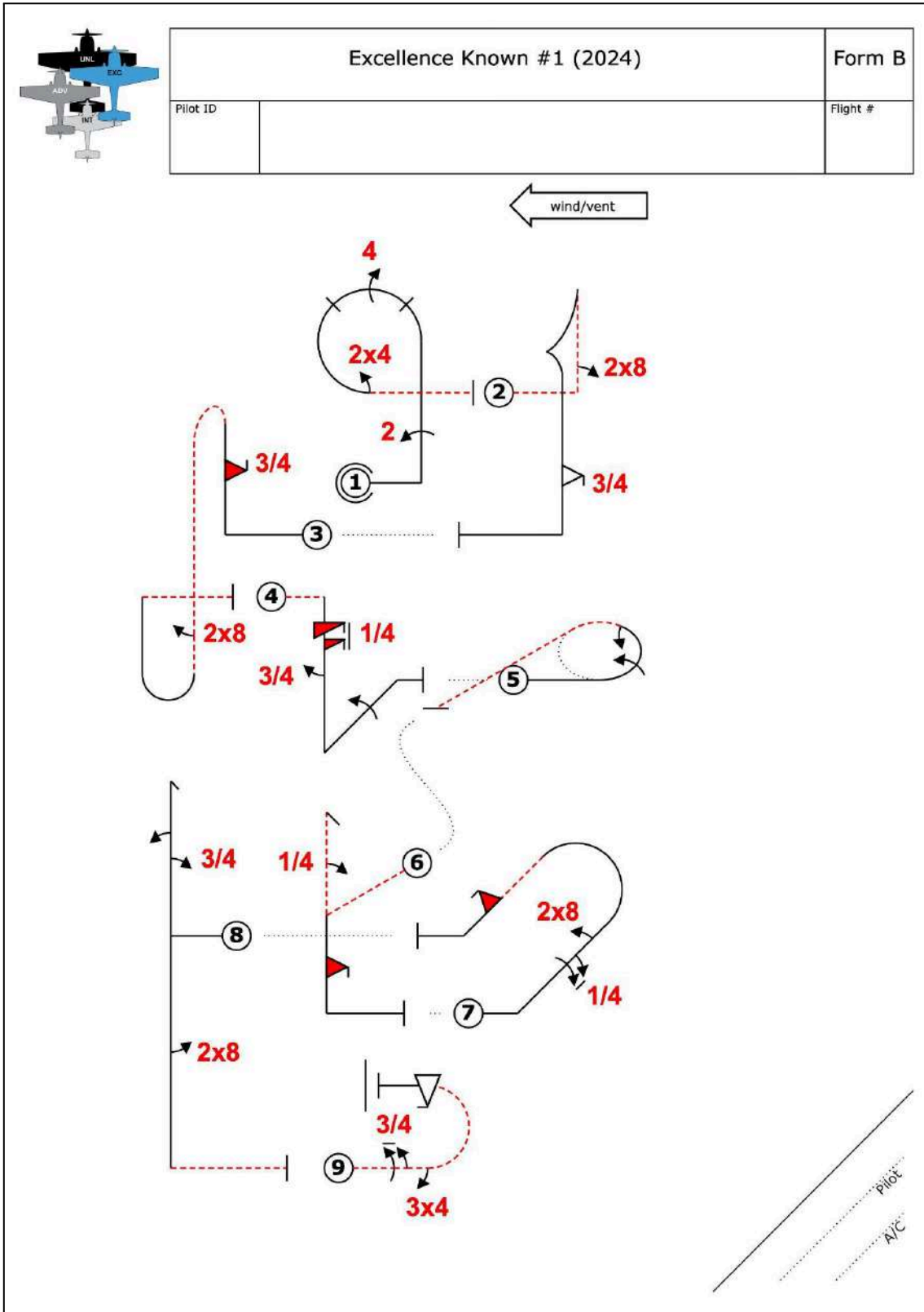



32ND FAI WORLD AEROBATIC CHAMPIONSHIPS
1ST OPEN EXCELLENCE AEROBATIC CHALLENGE
 15TH - 25TH AUGUST 2024
ZAMOSC - POLAND

BULLETIN WAC 2024-1 Rev. 5 8th April 2024

	Excellence Known #1 (2024)		Form C
	Pilot ID		Flight #

wind/vent →



32ND FAI WORLD AEROBATIC CHAMPIONSHIPS
1ST OPEN EXCELLENCE AEROBATIC CHALLENGE
 15TH - 25TH AUGUST 2024
ZAMOSC - POLAND

BULLETIN WAC 2024-1 Rev. 5 8th April 2024

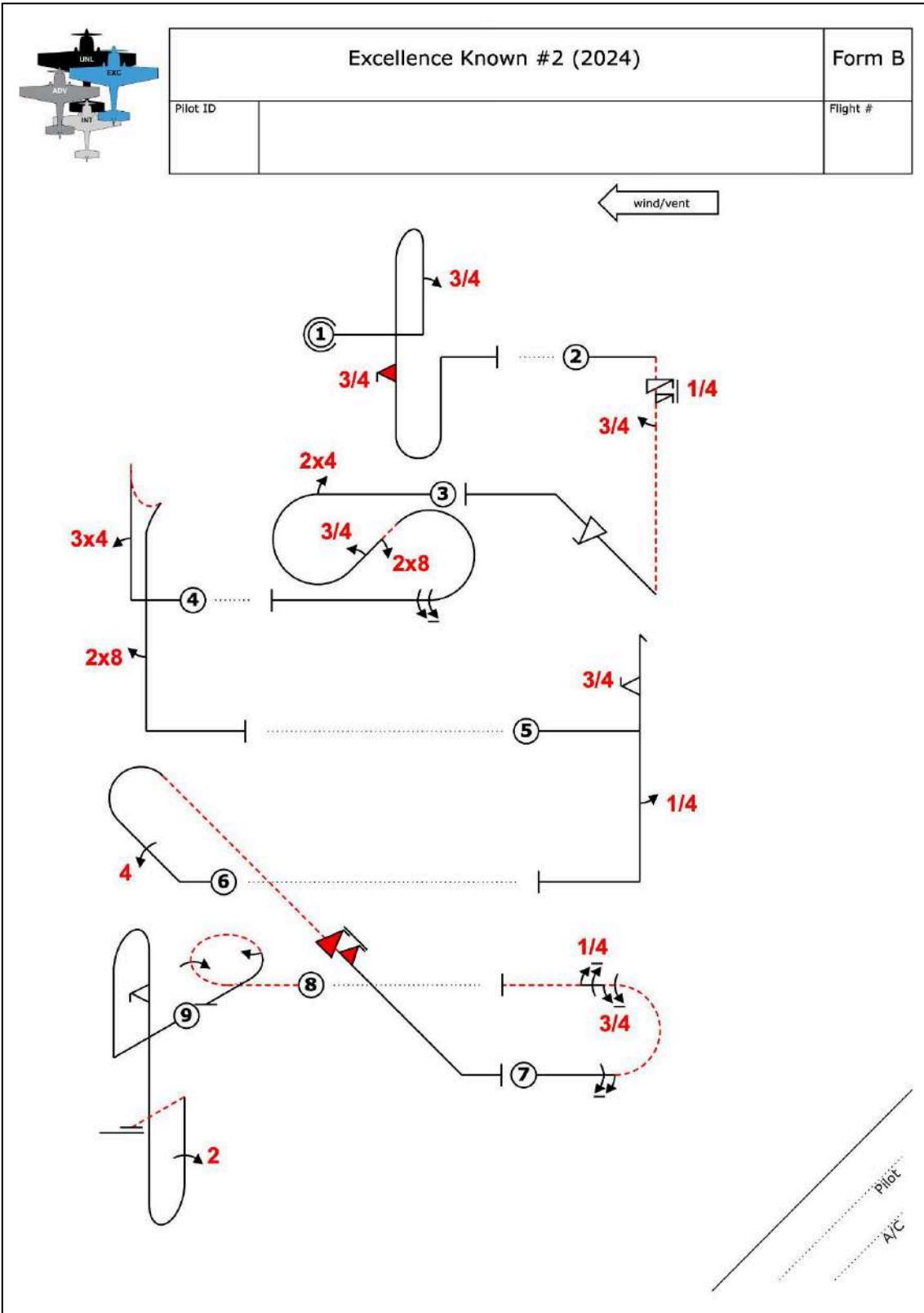



32ND FAI WORLD AEROBATIC CHAMPIONSHIPS
1ST OPEN EXCELLENCE AEROBATIC CHALLENGE
 15TH - 25TH AUGUST 2024
ZAMOSC - POLAND

BULLETIN
WAC 2024-1
 Rev. 5
 8th April 2024

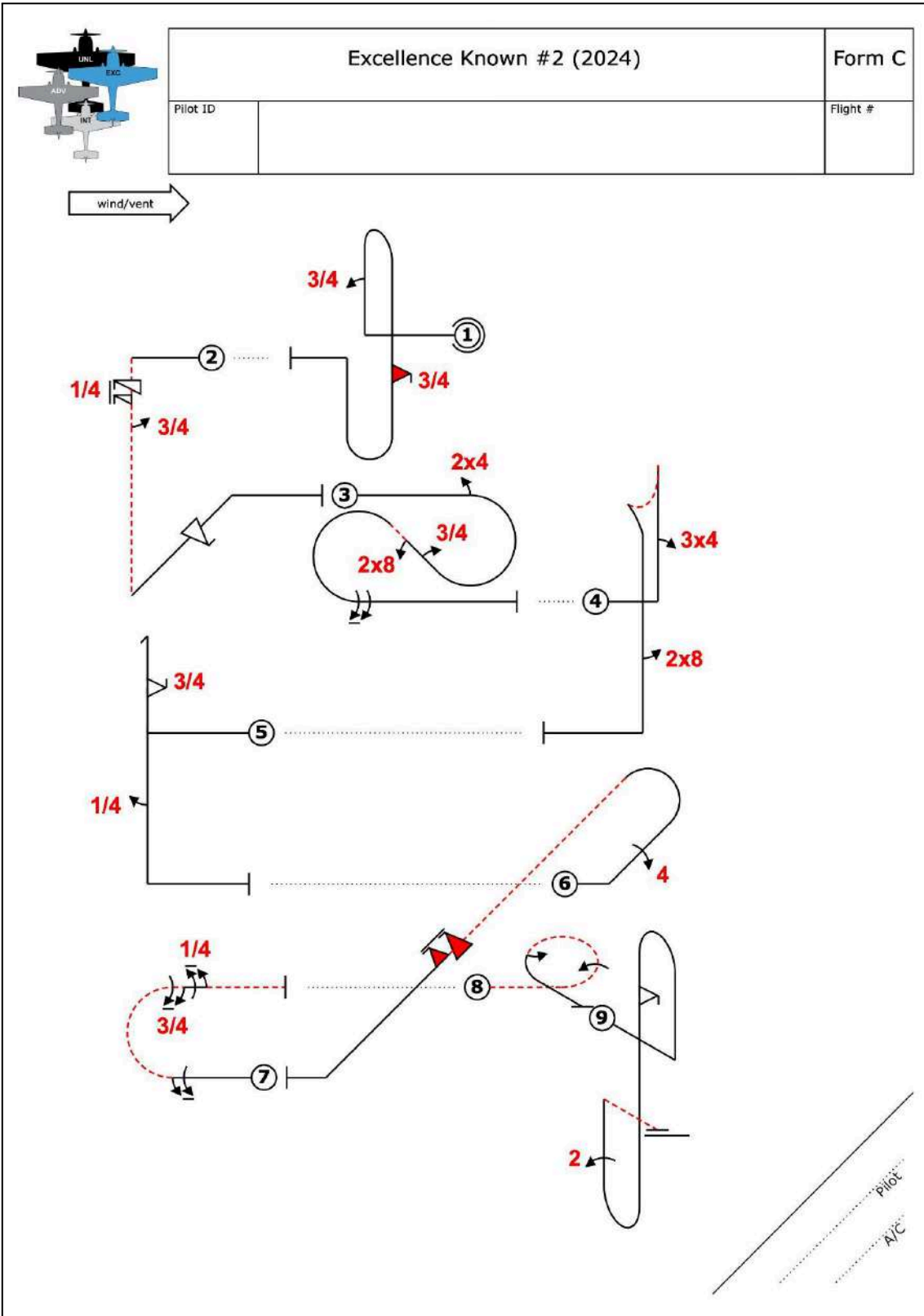

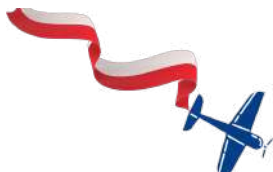

32ND FAI WORLD AEROBATIC CHAMPIONSHIPS
1ST OPEN EXCELLENCE AEROBATIC CHALLENGE
 15TH - 25TH AUGUST 2024
ZAMOSC - POLAND

BULLETIN WAC 2024-1 Rev. 5 8th April 2024

32nd FAI WAC / 1st OEAC Official Entry Form

Note: This Form is mandatory for each Team Member, individual Competitor and Observer. It must be submitted to: wac2024@aeroklubzamosc.pl

First and Family Name	
National Airport Control	
Date and Place of Birth	
FAI Sporting License N ^o	
Address	
Phone and Email Address	
Double or Single Room	
T- shirt Size	

Role (Please tick the correct one):

- Competitor
 Team Manager
 Coach
 Mechanic
 Observer
 Other:

Note: The following details are not mandatory for the successful Application. The related documents will be checked during the Registration Process. However, you will facilitate and simplify the next stage by submitting the following details:

Pilot Licence

Licence N^o Licence Validity:

Medical Validity:

Aircraft

Type: Registration:

Aviation Oil Type:

A NAC hereby confirms that the Pilot listed above is authorised to the Flights described in FAI Sporting Code, Section 6 Part 1.

Competitor's Signature	NAC's Representative's Signature