



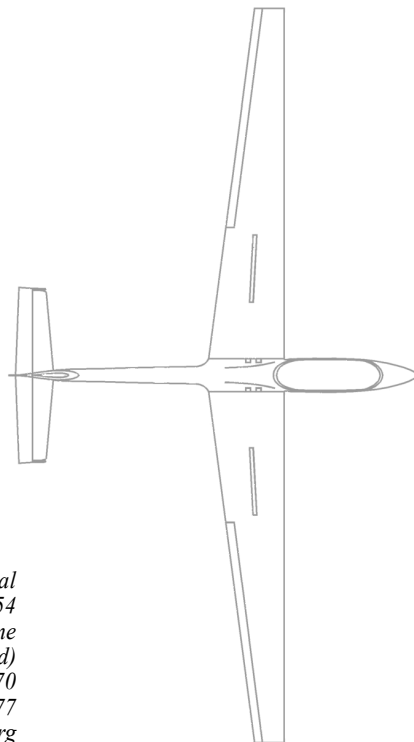
# FAI Sporting Code

---

*Fédération  
Aéronautique  
Internationale*

## Section 6

# Regulations for the Conduct of International Aerobatic Events



## Part 2 Glider Aircraft

*Maison du Sport International  
Av. de Rhodanie 54  
CH-1007 Lausanne  
(Switzerland)  
Tél. +41 (0)21 345 1070  
Fax +41 (0)21 345 1077  
E-Mail: [sec@fai.org](mailto:sec@fai.org)  
Web: [www.fai.org](http://www.fai.org)*

## Version 2026 V2

Effective 15<sup>th</sup> March 2026



**FEDERATION AERONAUTIQUE INTERNATIONALE  
MSI - Avenue de Rhodanie 54 – CH-1007 Lausanne – Switzerland**

---

Copyright 2025

All rights reserved. Copyright in this document is owned by the Fédération Aéronautique Internationale (FAI). Any person acting on behalf of the FAI or one of its Members is hereby authorised to copy, print, and distribute this document, subject to the following conditions:

- 1. The document may be used for information only and may not be exploited for commercial purposes.**
- 2. Any copy of this document or portion thereof must include this copyright notice.**
- 3. Regulations applicable to air law, air traffic and control in the respective countries are reserved in any event. They must be observed and, where applicable, take precedence over any sport regulations**

Note that any product, process or technology described in the document may be the subject of other Intellectual Property rights reserved by the Fédération Aéronautique Internationale or other entities and is not licensed hereunder.



## **RIGHTS TO FAI INTERNATIONAL SPORTING EVENTS**

All international sporting events organised wholly or partly under the rules of the Fédération Aéronautique Internationale (FAI) Sporting Code<sup>1</sup> are termed *FAI International Sporting Events*<sup>2</sup>. Under the FAI Statutes<sup>3</sup>, FAI owns and controls all rights relating to FAI International Sporting Events. FAI Members<sup>4</sup> shall, within their national territories<sup>5</sup>, enforce FAI ownership of FAI International Sporting Events and require them to be registered in the FAI Sporting Calendar<sup>6</sup>.

An event organiser who wishes to exploit rights to any commercial activity at such events shall seek prior agreement with FAI. The rights owned by FAI which may, by agreement, be transferred to event organisers include, but are not limited to advertising at or for FAI events, use of the event name or logo for merchandising purposes and use of any sound, image, program and/or data, whether recorded electronically or otherwise or transmitted in real time. This includes specifically all rights to the use of any material, electronic or other, including software, that forms part of any method or system for judging, scoring, performance evaluation or information utilised in any FAI International Sporting Event<sup>7</sup>.

Each FAI Air Sport Commission<sup>8</sup> may negotiate agreements, with FAI Members or other entities authorised by the appropriate FAI Member, for the transfer of all or parts of the rights to any FAI International Sporting Event (except World Air Games events<sup>9</sup>) in the discipline<sup>10</sup>, for which it is responsible<sup>11</sup> or waive the rights. Any such agreement or waiver, after approval by the appropriate Air Sport Commission President, shall be signed by FAI Officers<sup>12</sup>.

Any person or legal entity that accepts responsibility for organising an FAI Sporting Event, whether or not by written agreement, in doing so also accepts the proprietary rights of FAI as stated above. Where no transfer of rights has been agreed in writing, FAI shall retain all rights to the event. Regardless of any agreement or transfer of rights, FAI shall have, free of charge for its own archival and/or promotional use, full access to any sound and/or visual images of any FAI Sporting Event. The FAI also reserves the right to arrange at its own expense for any and all parts of any event to be recorded.

---

|          |  |
|----------|--|
| 1 .....  | FAI Statutes, ..... Chapter 1, para. 1.6                           |
| 2 .....  | FAI Sporting Code, Gen. Section, Chapter 4, para 4.1.2             |
| 3 .....  | FAI Statutes, ..... Chapter 1, para 1.8.1                          |
| 4 .....  | FAI Statutes, ..... Chapter 2, para 2.1.1; 2.4.2; 2.5.2 and 2.7.2  |
| 5 .....  | FAI By-Laws, ..... Chapter 1, para 1.2.1                           |
| 6 .....  | FAI Statutes, ..... Chapter 2, para 2.4.2.2.5                      |
| 7 .....  | FAI By-Laws, ..... Chapter 1, paras 1.2.2 to 1.2.5                 |
| 8 .....  | FAI Statutes, ..... Chapter 5, paras 5.1.1, 5.2, 5.2.3 and 5.2.3.3 |
| 9 .....  | FAI Sporting Code, Gen. Section, Chapter 4, para 4.1.5             |
| 10 ..... | FAI Sporting Code, Gen. Section, Chapter 2, para 2.2.              |
| 11 ..... | FAI Statutes, ..... Chapter 5, para 5.2.3.3.7                      |
| 12 ..... | FAI Statutes, ..... Chapter 6, para 6.1.2.1.3                      |



**Deliberately Blank**



**TABLE OF CONTENTS**

|           |   |           |
|-----------|---|-----------|
| <b>1.</b> | <b>GENERAL RULES FOR INTERNATIONAL GLIDER AEROBATIC EVENTS.....</b>   | <b>9</b>  |
| 1.1.      | Aims of Aerobatic Championships .....                                 | 9         |
| 1.2.      | General Regulations.....  | 9         |
| 1.2.1.    | <i>Contest Scopes</i> .....   | 9         |
| 1.2.2.    | <i>Contest Categories</i> .....                                       | 10        |
| 1.2.3.    | <i>Aircraft Restrictions</i> .....                                    | 10        |
| 1.2.4.    | <i>Competitors' Eligibility Restrictions</i> .....                    | 10        |
| 1.2.5.    | <i>Minimum Number of Competitors</i> .....                            | 10        |
| 1.2.6.    | <i>Competitors and Team Composition</i> .....                         | 10        |
| 1.2.7.    | <i>Aircraft Documentation</i> .....                                   | 11        |
| 1.2.8.    | <i>Air Safety</i> .....   | 11        |
| 1.2.9.    | <i>Insurance</i> .....  | 12        |
| 1.2.10.   | <i>Internal Communications</i> .....                                  | 12        |
| 1.3.      | Contest Bodies .....  | 12        |
| 1.3.1.    | <i>International Jury</i> .....                                       | 12        |
| 1.3.2.    | <i>Board of Judges</i> .....  | 14        |
| 1.3.3.    | <i>Contest Management</i> .....                                       | 16        |
| 1.3.4.    | <i>Technical Commission</i> .....                                     | 17        |
| 1.4.      | Administrative Arrangements.....                                      | 17        |
| 1.4.1.    | <i>Entries</i> .....  | 17        |
| 1.4.2.    | <i>Entry Fees</i> .....   | 17        |
| 1.4.3.    | <i>Accommodation, Food and Medical Services</i> .....                 | 17        |
| 1.4.4.    | <i>Towing Aircraft and Crews</i> .....                                | 18        |
| 1.4.5.    | <i>Warm-Up Pilots</i> .....   | 18        |
| 1.4.6.    | <i>Technical Services</i> .....                                       | 18        |
| 1.4.7.    | <i>Interpreters</i> .....   | 18        |
| 1.5.      | Final Regulations.....  | 18        |
| 1.5.1.    | <i>Interpretation</i> .....   | 18        |
| 1.5.2.    | <i>Competitors' Pledge</i> .....                                      | 19        |
| 1.5.3.    | <i>Supplementary Rules</i> .....                                      | 19        |
| <b>2.</b> | <b>PROGRAMMES FOR WORLD CHAMPIONSHIPS .....</b>                       | <b>20</b> |
| 2.1.      | Sequence of Programmes .....  | 20        |
| 2.2.      | Free Known (Programme 1).....   | 20        |
| 2.3.      | Unknown Compulsory and Free Programmes (Programmes 2 through 6) ..... | 22        |
| 2.3.1.    | <i>Figure Selection</i> .....   | 22        |
| 2.3.2.    | <i>Sequence Submission</i> .....                                      | 23        |
| 2.3.3.    | <i>Unknown Compulsories (Programmes 2, 4, 5 and 6)</i> .....          | 24        |
| 2.3.4.    | <i>Free Program (Programme 3)</i> .....                               | 24        |
| 2.4.      | Allowed Figures "AG" .....  | 24        |
| 2.5.      | Super-Slow Rolls .....  | 25        |
| 2.6.      | Coefficients for the Programmes "UG".....                             | 25        |
| 2.7.      | Coefficients for the Programmes "AG" .....                            | 25        |
| <b>3.</b> | <b>THE ORGANISATION OF WORLD GLIDER AEROBATIC CHAMPIONSHIPS .....</b> | <b>26</b> |
| 3.1.      | Briefings .....   | 26        |
| 3.2.      | Familiarisation Flights .....   | 26        |
| 3.3.      | Sequence of Flights (Drawing of Lots) .....                           | 26        |
| 3.4.      | Performance Zone .....  | 27        |
| 3.5.      | Warm-Up Flights .....   | 28        |
| 3.6.      | Video / Audio Devices.....  | 28        |



|                   |   |           |
|-------------------|---|-----------|
| 3.7.              | Meteorological Conditions .....   | 29        |
| 3.8.              | Conduct of Competition Flights .....  | 32        |
| 3.9.              | Height Limitations .....  | 32        |
| 3.10.             | No Radio Procedure .....  | 33        |
| 3.11.             | Measures in Case of Mechanical Defects .....  | 33        |
| 3.12.             | Protests .....  | 34        |
| <b>4.</b>         | <b>EVALUATION OF COMPETITION FLIGHTS .....</b>  | <b>35</b> |
| 4.1.              | Evaluation of the Performance .....   | 35        |
| 4.1.1.            | <i>The Chief Judge</i> .....  | 35        |
| 4.1.2.            | <i>Judges</i> .....   | 36        |
| 4.1.3.            | <i>Recording of Insertions, Height Infringements, Infringements of the Performance Zone and improper Wing-Dipping</i> ..... | 37        |
| 4.1.4.            | <i>Marks for Figures</i> .....  | 37        |
| 4.1.5.            | <i>Marking of Positioning and Symmetry</i> .....  | 38        |
| 4.1.6.            | <i>Calculation of Scores</i> .....  | 39        |
| 4.2.              | Boundary Judging .....  | 39        |
| 4.3.              | Electronic Height Measuring .....   | 39        |
| 4.4.              | Penalties Deductible from Total (Averaged) Scores .....   | 39        |
| 4.4.1.            | <i>Infringements of Height Limits</i> .....   | 39        |
| 4.4.2.            | <i>Infringements of the Performance Zone</i> .....  | 40        |
| 4.4.3.            | <i>Insertions</i> .....   | 40        |
| 4.4.4.            | <i>Violation of Training</i> .....  | 40        |
| 4.4.5.            | <i>Failure to Appear</i> .....  | 41        |
| 4.4.6.            | <i>Improper Wing-Dipping at the Beginning or End of a Programme</i> .....   | 41        |
| 4.4.7.            | <i>Violation of Flight Regulations and Dangerous Flying</i> .....   | 41        |
| 4.5.              | Deductions applicable to Figures .....  | 41        |
| 4.5.1.            | <i>Downgrades</i> .....   | 41        |
| 4.5.2.            | <i>Hard Zero</i> .....  | 42        |
| 4.5.3.            | <i>Alignment on Hard Zeros</i> .....  | 43        |
| 4.5.4.            | <i>Errors in Recording Hard Zeros</i> .....   | 43        |
| 4.5.5.            | <i>Mix of Zeros</i> .....   | 44        |
| 4.6.              | Judging Administration .....  | 44        |
| 4.6.1.            | <i>Paperwork</i> .....  | 44        |
| 4.6.2.            | <i>Collection of Marking Sheets</i> .....   | 44        |
| 4.6.3.            | <i>Publication of Results</i> .....   | 44        |
| 4.6.4.            | <i>Public Announcements</i> .....   | 45        |
| 4.6.5.            | <i>Official Video Recording</i> .....   | 45        |
| 4.6.6.            | <i>Judges' Performance Evaluation</i> .....   | 45        |
| 4.6.7.            | <i>Reprimand and Disqualification of Judges</i> .....   | 45        |
| 4.6.8.            | <i>Substitute Judge</i> .....   | 45        |
| <b>5.</b>         | <b>AWARDS .....</b>   | <b>46</b> |
| 5.1.              | Titles definition .....   | 46        |
| 5.2.              | Generalities .....  | 46        |
| 5.3.              | Unlimited Contests .....  | 47        |
| 5.3.1.            | <i>World Championships</i> .....  | 47        |
| 5.4.              | Advanced Contests .....   | 48        |
| 5.4.1.            | <i>World Championships</i> .....  | 48        |
| <b>APPENDICES</b> | <b>49</b>   |           |
| <b>A.</b>         | <b>APPENDIX A: LIST OF FIGURES FOR PROGRAMMES 2 THROUGH 6 .....</b>   | <b>50</b> |
| A.1.              | Colour Coding .....   | 50        |



|           |   |           |
|-----------|---|-----------|
| A.2.      | Roll and Spin Combinations .....  | 50        |
| A.3.      | Family 1.1, Single Lines .....  | 50        |
| A.4.      | Family 1.2, Two Lines .....   | 51        |
| A.5.      | Family 2, Turns and Rolling Turns .....   | 52        |
| A.6.      | Family 5, Stall Turns .....   | 53        |
| A.7.      | Family 6, Tail Slides .....   | 54        |
| A.8.      | Families 7.2, Half Loops and 7.3, Three-Quarter Loops .....                                     | 55        |
| A.9.      | Family 7.4, Full Loops .....  | 56        |
| A.10.     | Family 7.8.1 to 7.8.8, Horizontal Eights .....  | 57        |
| A.11.     | Family 7.8.9 to 7.8.15, Horizontal Super-Eights .....   | 58        |
| A.12.     | Family 8.4, Humpties .....  | 59        |
| A.13.     | Family 8.5, Half Cubans .....   | 61        |
| A.14.     | Family 8.6, P-Loops .....   | 63        |
| A.14.     | Family 8.6.17 to 8.6.23 P-Loops with Half Rolls on Top .....                                    | 65        |
| A.15.     | Family 8.6.13, 8.6.14, Reversing P-Loops and Family 8.7, Q-Loops .....                          | 67        |
| A.16.     | Family 9.1, Aileron Rolls .....   | 68        |
| A.17.     | Family 9.2, 2-Point Rolls .....   | 68        |
| A.18.     | Family 9.4, 4-Point Rolls .....   | 69        |
| A.19.     | Family 9.8, 8-Point Rolls .....   | 69        |
| A.20.     | Family 9.9, Positive Flick Rolls .....  | 70        |
| A.21.     | Family 9.10, Negative Flick Rolls .....   | 71        |
| A.22.     | Family 9.11, Positive Spins .....   | 72        |
| A.23.     | Family 9.12, Negative Spins .....   | 72        |
| <b>B.</b> | <b>APPENDIX B: CRITERIA FOR JUDGING GLIDER AEROBATIC FIGURES .....</b>                          | <b>73</b> |
| B.1.      | Preface .....   | 73        |
| B.2.      | Definitions .....   | 73        |
| B.2.1.    | <i>Angle of Attack</i> .....  | 73        |
| B.2.2.    | <i>Angle of Incidence</i> .....   | 73        |
| B.2.3.    | <i>Figure</i> .....   | 73        |
| B.2.4.    | <i>Manoeuvre</i> .....  | 73        |
| B.2.5.    | <i>Mark/Point/Score</i> .....   | 73        |
| B.2.6.    | <i>Plane of Flight</i> .....  | 73        |
| B.3.      | Flight Path and Attitude .....  | 74        |
| B.3.1.    | <i>Flight Path</i> .....  | 74        |
| B.3.2.    | <i>Vertical Attitude</i> .....  | 74        |
| B.3.3.    | <i>The 45 degree Attitude</i> .....   | 75        |
| B.4.      | Marking .....   | 75        |
| B.5.      | Summary .....   | 75        |
| B.6.      | Box Axes .....  | 76        |
| B.7.      | Wind Correction .....   | 76        |
| B.8.      | The Two Basic Components of Aerobatic Construction: Lines and Loops .....                       | 77        |
| B.8.1.    | <i>Lines</i> .....  | 77        |
| B.8.2.    | <i>Loops and Part Loops</i> .....   | 79        |
| B.9.      | Aresti System (Condensed) Glider Families .....   | 80        |
| B.9.1.    | <i>Family 1 – Lines and Angles</i> .....  | 80        |
| B.9.2.    | <i>Family 2.1.1, 2.2.1, 2.3.1 and 2.4.1 – Turns</i> .....                                       | 80        |
| B.9.3.    | <i>Family 2.1.2, 2.1.3, 2.2.2 - 2.2.6, 2.3.2 -2.3.5 and 2.4.2 - 2.4.8 – Rolling Turns</i> ..... | 81        |
| B.9.4.    | <i>Family 3 – Combinations of Lines</i> .....   | 83        |
| B.9.5.    | <i>Family 5 – Stall Turns</i> .....   | 84        |
| B.9.6.    | <i>Family 6 – Tailslides</i> .....  | 85        |
| B.9.7.    | <i>Family 7 – Loops and Figure 8's</i> .....  | 86        |
| B.9.8.    | <i>Combination of loop elements with rolls on horizontal lines</i> .....                        | 86        |
| B.9.9.    | <i>Family 7.3 – Three Quarter Loops</i> .....   | 87        |



|   |           |
|---|-----------|
| B.9.10. Family 7.4.1 - 7.4.2 – Round Loops .....  | 87        |
| B.9.11. Family 7.4.3 - 7.4.6 – Square, Diamond and Octagon Loops .....  | 87        |
| B.9.12. Family 7.4.7 - 7.4.14 – Reversing Whole Loops.....  | 88        |
| B.9.13. Family 7.5.1 - 7.5.8 – Horizontal S's.....  | 88        |
| B.9.14. Family 7.8.1 - 7.8.8 – Horizontal 8's.....  | 88        |
| B.9.15. Family 7.8.9 - 7.8.16 – Horizontal Super 8's.....   | 89        |
| B.9.16. Family 8 – Combinations of Lines, Loops and Rolls .....   | 89        |
| B.9.17. Family 8.4 – Humpties .....   | 89        |
| B.9.18. Families 8.5.1 - 8.5.8, 8.6.1 - 8.6.8 and 8. 7 – Half Cubans, Reverse Half Cubans, P-Loops and Q-Loops..... | 89        |
| B.9.19. Family 8.5.9 - 8.5.24 – Teardrops.....  | 89        |
| B.9.20. Families 8.6.9 - 8.6.16 and 8-10 – Reversing P-Loops and Reversing 1¼ Loops.....                            | 90        |
| B.9.21. Family 8.8 – Double Humpties .....  | 90        |
| B.9.22. Family 9 – Rolls and Spins .....  | 90        |
| B.9.23. Family 9.1 – Aileron Rolls .....  | 91        |
| B.9.24. Family 9.2 - 9.8 – Hesitation Rolls.....  | 91        |
| B.9.25. Family 9.10 – Negative Flick Rolls .....  | 93        |
| B.9.26. Family 9.11 and 9.12 – Spins.....   | 93        |
| B.10. Positioning .....   | 94        |
| B.10.2. Optimal Placement of Figures.....   | 94        |
| B.10.3. Sequence Symmetry.....  | 94        |
| <b>C. APPENDIX C: RULES FOR THE USE OF ELECTRONIC HEIGHT MEASURING DEVICES (HMDS) .....</b>                         | <b>95</b> |
| C.1. Types of HMDs.....   | 95        |
| C.2. Types of HMDs.....   | 95        |
| C.3. Technical Characteristics .....  | 95        |
| C.4. Operating the HMD .....  | 95        |
| C.5. Malfunction or Failure of the HMD.....   | 96        |
| C.6. Approval of HMDs.....  | 96        |
| <b>RECORD OF AMENDMENTS .....</b>   | <b>98</b> |

## **GLOSSARY**

|                     |  |
|---------------------|--|
| Discipline .....    | Aerobatics   |
| Contest Scope ..... | World, Continental, Other International Competitions |
| Class.....          | Glider   |
| Category .....      | Unlimited, Advanced                                  |



## **1. GENERAL RULES FOR INTERNATIONAL GLIDER AEROBATIC EVENTS**

### **1.1. Aims of Aerobatic Championships**

- 1.1.1.1 To establish the overall champions and the winners in the individual programmes.
- 1.1.1.2 To establish the champion teams.
- 1.1.1.3 To promote the sporting skill of aerobatic pilots of FAI member aero clubs and arrange competitive contests between aerobatic pilots of FAI member aero clubs, and to allow aerobatic pilots the maximum opportunity to demonstrate within the scope of the general rules their ability in competition with others.
- 1.1.1.4 To promote and popularise aerobatics and to develop and foster friendly relations between aerobatic pilots of different countries.
- 1.1.1.5 In pursuance of these aims and in case of dispute over the interpretation and application of these rules, and any other regulations for the conduct of aerobatic championships and competitions, a competitor shall be entitled to the benefit of reasonable doubt.

### **1.2. General Regulations**

#### **1.2.1. Contest Scopes**

##### **1.2.1.1 World Championships**

- a) World Championships will be held every year. The duration of World Glider Aerobatic Championships is recommended to be no more than 9 days between opening and closing ceremonies. Opening and closing dates should be selected so as to allow competitors to travel to/from the contest site on weekends.
- b) A National Airports Control (NAC), or other legal entity<sup>13</sup>, which has applied to be host and organiser will be entrusted with the organisation of World Championships pending approval by CIVA.
- c) The organisers will provide conditions for entry and participation for any national FAI member aero club on equal rights basis and will carry out the World Championships on the basis of the decisions and rules of the FAI.
- d) Each NAC will be notified by the organiser, not later than 6 months before the beginning of the championships, of any general organisational conditions such as time, place, travel and visa formalities, entry forms, entry deadline, etc.
- e) CIVA shall decide at the meeting which precedes a World Championship which FAI language(s) shall be used as the working language(s) both orally and in writing for all purposes for the duration of the championships.

##### **1.2.1.2 Continental Championships**

CIVA agreed in 2010 to hold World Glider Aerobatic Championships every year, so there will be no more Continental Glider Aerobatic Championships until further notice. References to Continental Championships have been removed.

---

<sup>13</sup> For the sake of wording simplification, in the rest of this document the wording "Organising NAC" may refer to a NAC, another type of FAI member as appropriate, or another entrusted entity. Likewise, for participating countries, the wording "NAC" may refer either to the NAC or to the relevant FAI member if not a NAC.



1.2.1.3 Other International Competitions

- a) Organisers will be a national FAI member aero club.
- b) International contests must be made known to the FAI for inclusion in the calendar of international events by October of the year preceding the contest.
- c) Any national FAI member aero club may be invited to participate in an international contest.
- d) Each participating national FAI member aero club will be notified by the organising aero club not later than 3 months before the beginning of the contest of any general organisational details and of details specifically relevant to the contest.

**1.2.2. Contest Categories**

1.2.2.1 Contest categories are:

- a) Unlimited Glider("UG")
- b) Advanced Glider("AG")

**1.2.3. Aircraft Restrictions**

1.2.3.1 World Glider Aerobatic Championships are open to glider aircraft only.

**1.2.4. Competitors' Eligibility Restrictions**

1.2.4.1 Eligibility "AG"

- a) A competitor who achieves an aggregate score of 60% or more in the programmes he/she flew at a World Glider Aerobatic championship, may subsequently participate in an Advanced championship only in an Hors Concours capacity during that calendar year and the following two calendar years, subject to acceptance by the organiser per 1.2.6.3.
- b) The same applies to pilots who have flown in an Unlimited or Advanced international championship for powered aircraft, during the year of an Advanced glider contest or in the preceding two years.

**1.2.5. Minimum Number of Competitors**

1.2.5.1 World Glider Aerobatic Championships will be held or recognised as such if there are at least 15 competitors from at least 5 countries.

**1.2.6. Competitors and Team Composition**

1.2.6.1 World Championships "UG" and "AG"

- a) National Air sports Controls shall notify the organisers of a World Championship, not less than two months before it is due to start, of the number of competing pilots to be entered from their national aero club up to a maximum of eight (8). The organisers shall have the right, without reference to CIVA, to reduce this maximum number of pilots of each nation from 8 to 6 competitors. In this event the organisers shall at once notify NACs accordingly.
- b) In the event that fewer than 4 teams comprised of 3 or more pilots compete, the number of pilots required to constitute a team will be reduced to 2. The requirements of paragraph 1.2.5.1 still apply.
- c) Solo entries will be accepted from NACs.
- d) The team of each NAC may include the following officials: 1 chief delegate, 1 team manager, 1 trainer, 1 doctor, 1 interpreter, and no more than 3 mechanics.



- e) Every competitor must be a member of his or her NAC and must be in possession of a valid FAI sporting licence.
- f) Every official must be a member of his or her NAC.
- g) The admission of observers depends on the facilities available and is subject to agreement with the organiser.

#### 1.2.6.2 Non-NAC Entries

- a) The Organiser is also obliged to accept entries from competitors in possession of a valid FAI Sporting Licence issued by FAI, as described in paragraph 3.3.2. of Sporting Code, General Section.

#### 1.2.6.3 Hors-Concours Entries

- a) At their discretion, Organisers may accept further entries from pilots not representing their NAC. These entrants will be classified as "Hors Concours (H/C)". Nevertheless, such entries may be submitted by NACs' authorized representatives only (see 1.4.1.2). They will pay normal entry fees, subject to the normal entry deadlines for the contest, and be treated as other competitors. In the event of time constraints, they can expect to be shifted in the order of flight or deleted from the flight programmes altogether at the discretion of the International Jury. H/C pilots' results will be located in all listings as their score dictates but with no rank awarded. They will not appear in the final results submitted to FAI and will not be eligible for any awards or medals.
- b) H/C pilots shall possess a current FAI Sporting License.

- 1.2.6.4 Replacements of competitors at Championships will be left to the discretion of the International Jury, but no such replacement will in any case be permitted less than 12 hours before the commencement of the first competition flight.

### 1.2.7. Aircraft Documentation

- 1.2.7.1 A valid aerobatic certificate of airworthiness or equivalent document issued by the competent aviation authority of the aircraft's state of registration must be produced to the Organiser for every contest aircraft.
- 1.2.7.2 Aircraft will not be admitted to the contest unless the appropriate documentation has been submitted to the organisers.
- 1.2.7.3 A contest aircraft may on the recommendation of the technical commission and with the permission of the International Jury be replaced at any time by another contest aircraft.

### 1.2.8. Air Safety

- 1.2.8.1 All flights carried out by competitors at World Championships must be made solo; this applies to competition and training flights.
- 1.2.8.2 All competitors must observe and adhere to the regulations currently in force in the Organiser's country for air safety as well as the special regulations in force at the contest aerodrome, starting from the arrival at the championship site of the competitor to his/her departure after the championship, including but not limited to training and official training flights. To facilitate this, the Organiser must ensure that an English translation of applicable rules, issued by the Aviation or Customs Authorities of the host country, is available in advance in an event bulletin or on the competition website, and that the relevant safety organisation and systems are in place to enable compliance. Team managers and team coaches make sure that all competitors are briefed on safety in general and on the specific regulations mentioned in this paragraph.



- 1.2.8.3 Any violation of the safety regulations in force may at any time render the offender liable to exclusion from the contest. No responsibility will be undertaken by the organisers for any such violation by competitors or others.
- 1.2.8.4 To enable the pilot to watch over his or her own safety, an accelerometer must be installed in each competing aircraft.
- 1.2.8.5 The Chief Judge may exclude a pilot from the event who is not flying safely or whose flying might reasonably be judged to be the imminent cause of an unsafe situation.

#### **1.2.9. Insurance**

- 1.2.9.1 The organisers will provide a promoter's liability insurance of an adequate sum against third party risks for the duration of the contest covering functional test flights, training and competition flights, in accordance with the legal requirements of the country in which the championships or competition is held. The organisers must further have insurance for damages to competition gliders etc., caused by the organiser or his staff.
- 1.2.9.2 All competitors must produce evidence of adequate third-party insurance valid for the duration of the contest and valid in the organiser's country. The organisers should specify in the local regulations the amount of insurance cover regarded as adequate.

#### **1.2.10. Internal Communications**

- 1.2.10.1 The organisers of World Championships must establish an efficient radio or telephone communication system between the Contest Officials (Contest Director, President of the International Jury, Chief Judge, Flight Director, Chairman of the Technical Commission and all Boundary Judges) in order to supervise the running of the contest and the contest rules.
- 1.2.10.2 Reliability of radio communication between the contest officials is a safety-critical item requiring a professional standard of equipment. Domestic type walkie-talkies are not adequate for this duty.

### **1.3. Contest Bodies**

#### **1.3.1. International Jury**

- 1.3.1.1 The International Jury is the supreme arbitration body of international aerobatic events. The activities of the International Jury will be organised by the President from the opening of the contest. The Jury President will allot duties to each of the members of the jury every day. The duties of the International Jury include:
  - a) Interpreting the general rules, the judging rules and the general regulations of the contests.
  - b) Meetings
    - i) Attend the meetings of the International Board of Judges (dealing with familiarisation, evaluation, checking the marking sheets).
    - ii) If required, hold daily evaluation meetings (after the daily contest programme has been completed).
    - iii) Hold a final meeting to evaluate the activities of the International Jury and the development of the contest and for the president to prepare his report to CIVA.



- c) Supervision
- i) Selecting at least one Warm-Up pilot several months prior to the event, based on applications to be sent by NACs to the President of the International Jury before a deadline to be announced for each event.
  - ii) Providing the CIVA “Declaration of Ethical Behaviour” sheet to the Chief Judge, who will sign it and require all other members of the Board of Judges to enter their name, signature and date to warrant their compliance with the requirements of this declaration before competition flights commence. The International Jury will retain this signed sheet among their official records for the event.
  - iii) Supervising the activities of the Chief Judge and the Board of Judges. This is to include preparation of the judging analysis for all judges. During judging, members of the International Jury must not remain in the vicinity of the International Judges.
  - iv) iv) Checking the operation of the electronic positioning device and supervising the official recording boundary infringements.
  - v) v) Controlling the Unknown Programmes in accordance with para 1 including supervision, composition and explanation, as appropriate.
  - vi) vi) Supervising the briefings and the drawing of lots.
  - vii) vii) Supervising the activities of the Scoring Office.
  - viii) viii) Supervising the activities of the Meteorological Centre.
  - ix) ix) Supervising the activities of the Technical Commission.
  - x) x) Checking the publication of contest results; making visits to the pilots' camp to gather or give information.
  - xi) xi) Checking the availability and accuracy of medals, diplomas and trophies at the beginning of the competition.
  - xii) xii) Overseeing the administration of the contest and ensuring that the organisers meet the requirements as stipulated in the regulatory documents and organisational guides provided by CIVA for such events.
- d) Mediation
- i) Dealing with protests, discuss protests, if necessary, in cooperation with the Chief Judge, the Flight Director, the Chairman of the Technical Commission, and the Contest Director.
  - ii) Take down on record the proceedings in meetings or activities where decisions are sought (e.g. a note of comments, resolutions, etc.). The International Jury will publish the results of all protests and decisions. Meetings of the International Jury must not impede the progress of the contest.
  - iii) Hold explanatory discussions with chief delegates and team managers to explain measures taken by the Jury; interpretation of the FAI Sporting Code and all regulations. This should be done after completion of the daily competition flying or before the beginning of competition flying (i.e. in any case without impeding the progress of the contest).



1.3.1.2 Organiser's Responsibility

- a) The organisers of international aerobatic events must provide the necessary material and technical conditions and the required number of staff in order to enable the International Jury to carry out its functions.

1.3.1.3 Appointment

- a) The International Jury at World Championships will be appointed by the FAI Aerobatics Commission (CIVA) and will consist of a chairman and at least 2 members with adequate reserves, who must be members of different national aero clubs. The Chief Judge shall be an advisory member of the International Jury and the Contest Director shall be advisor to it.
- b) Only members of the CIVA Bureau, Delegates or Alternate Delegates to CIVA or a qualified person nominated by the CIVA Bureau are eligible to serve as Jury President. The chairperson of the Glider Aerobatics Committee of CIVA may also be Jury President, even if he or she is not a Delegate to CIVA.

1.3.1.4 All three members of the International Jury must be available on-site for the duration of the championship.

1.3.1.5 Any decision taken by the International Jury by majority vote is final.

1.3.1.6 The International Jury may temporarily vary any rules approved by the International Aerobatics Commission (CIVA) during a contest under the following circumstances:

- a) There is simple majority agreement within the International Jury, with no abstentions, when conducting a vote to introduce a temporary variation to the regulations, and
- b) There is two-thirds majority amongst the participating teams' Chief Delegates, with no abstentions, when conducting a vote to introduce a temporary variation to the regulations.

1.3.1.7 In the event that the rules of the Sporting Code are not adhered to at a World Championship, or if the International Jury is not provided with sufficient information to perform their duties in accordance with the rules, the International Jury may stop the contest until matters are remedied.

- a) If remedial action is not taken, the International Jury has the power to declare that the requirements of a World Championship have not been fulfilled in accordance with the rules. If this latter action is taken, the International Jury shall prepare a full report for submission to the next meeting of CIVA at which their decision shall either be endorsed or reversed.

**1.3.2. Board of Judges**

Judging during World Glider Aerobatic Championships will be carried out by an International Board of Judges in compliance with the following rules.

1.3.2.1 At World Championships the International Board of Judges will be composed of:

- a) The Chief Judge
- b) Two Assistants to the Chief Judge to be chosen by the Chief Judge to provide the administrative services described in 4.1.1.2
- c) A maximum of 10 International Judges and 10 assistants and a minimum of 7 International Judges and 7 assistants for marking the quality of aerobatic manoeuvres and positioning.
- d) The operators of the height measuring and position tracking system.



1.3.2.2 The Chief Judge

- a) For World Championships the Chief Judge will be selected and appointed by CIVA; he/she may not be a citizen of the organiser's country (exceptions to this must be accepted by CIVA).
- b) In any case, the Chief Judge must be an International Judge listed in the FAI official record and must have previous experience of serving as Chief Judge at an international aerobatic event (or a major national competition) run under FAI rules.

1.3.2.3 Representation on the Board of Judges

- a) At World Championships judges will be invited to apply for selection, irrespective of their nationality, based on their previous RI performance data as recorded in the CIVA Judges Performance Database (JPD). New judge applications for those without International RI performance data can be made by NACs or individuals but must be accompanied by current RI data produced by the FPS scoring system at a National Competition (not necessarily in their own country). These applications must be made by the deadline published by CIVA in the year in which the Championships are to be held.
- b) Judges are subsequently selected in accordance with procedures established by CIVA. The selection process includes a ranking of judges by the RIs in the JPD from past Championships. A minimum of seven and a maximum of ten judges can be selected for glider Unlimited/Advanced category championships. A maximum of two judges per NAC may be appointed when the panel exceeds seven members, otherwise the nations represented shall be all different.
- c) The contest organiser shall provide accommodation, food and local transport to them and their assistants, with no entry fees, when a full panel is supported by CIVA and the organiser. If the organisers bid supports less than the maximum then judges and assistants not included in the minimum panel selected by CIVA may individually or through their NAC offer to self-fund, in which case organisers shall accept them at a preferential rate determined to cover only the same accommodation, food and transportation costs as those for the judges selected for the minimum panel.
- d) Final selection will be ratified by the Bureau of CIVA.
- e) If any judge(s) are not available and cannot complete their functions and the minimum number of judges are not present, the International Jury will use its discretion in filling the available slot(s).

1.3.2.4 Qualification of Judges

- a) All International Judges selected for the Championships must have been approved by the International Aerobatics Commission (CIVA) of FAI and listed in the FAI official document to that effect. A judge may not be deleted from the International Judges list who has valid and acceptable JPD data listed in the previous five years. Should a Judge, who has existing acceptable JPD or who is new applicant, not be supported by their home Aero Club, he/she will be listed in the International Judges List, in an International Section. Their Nationality will be shown in brackets after their name.
- b) To be a current FAI judge at FAI aerobatic championships, an FAI International Judge must additionally fulfil the following currency requirements:
  - i) In the year in which the championship is held or during the previous calendar year, the judge must have judged at a national or international aerobatic championship of the appropriate category (Advanced or Unlimited).



- ii) Before the final selection process, all judges and assistants must also attend and satisfactorily complete a judging review session presented by the Chief Judge.
- iii) The Chief Judge will ensure that the judge is in possession of current regulations with appropriate translation if necessary.
- c) All judges who wish to be represented on the Board of Judges must have a qualified assistant, who must also be approved by the Judging Committee and verified by the CIVA Bureau. Any change in assistant will require approval prior to the commencement of a contest or a programme by either the Judging Committee or Contest Jury as appropriate, without such approval the judge will be excluded. Assistant judges are required to take the online judging competency review.

#### 1.3.2.5 Electronic Tracking System

The operation of the electronic position tracking system must be monitored by a jury member or a neutral person assigned by the International Jury.

#### 1.3.2.6 Position of the Judges

The judges (rule 1.3.2.1c) will be posted by the Chief Judge at positions appropriate for observing the competitors, the positions of the judges being at least 15 m apart. The distance of the judges' positions from the end points of the x/y axes will be minimum 150 m and maximum 250 m.

#### 1.3.2.7 Marks given by the Judges

The International Judges appointed for marking the quality of the maneuvers will mark the maneuvers and infringements of the lower and upper height limits in compliance with the judging rules. (See 4.1.3.2 and 4.1.4.1)

#### 1.3.2.8 Judges' assistants

The assistant(s) has (have) the following tasks:

- a) Telling the judge prior to the performance the sequence of the figures, details of the various figures, and any other special features.
- b) Recording the mark given by the judge for each figure and writing down into the marking sheet any remarks concerning the rating. Any amendment of record must be signed by the judge.
- c) Giving general assistance.

### **1.3.3. Contest Management**

1.3.3.1 The Contest Director will be responsible for the regular and orderly performance of the contest. The Contest Director is responsible to the International Jury for the efficient administration of the contest.

1.3.3.2 The contest management will be composed of:

- a) The Contest Director,
- b) The Flight Director,
- c) The Chief Judge,
- d) The Chairman of the Technical Commission.

Whilst the Chief Judge is appointed by a CIVA election process, the individuals nominated to fill the other three positions must be approved by CIVA.



**1.3.4. Technical Commission**

- 1.3.4.1 The Technical Commission will be composed of 3 to 5 engineers or mechanics. CIVA compiles a list of capable engineers or mechanics nominated by the national aero clubs; written evidence as to qualification, experience and technical knowledge must be submitted by the national aero clubs. CIVA selects from the list of approved engineers and mechanics the members of the Technical Commission for World Championships; if possible, the selection of the members of the Technical Commission should be guided by the type of competing aircraft operated during the contest.
- 1.3.4.2 The representative of the organisers will be nominated as the Chairman of the Technical Commission.
- 1.3.4.3 The Technical Commission is responsible to the International Jury for the inspection of competing aircraft and of aircraft documentation; for certifying compliance with the airworthiness regulations of aircraft after inspection; for a qualified and objective inspection in case of defects of the technical equipment; and for finding the causes of defects which have occurred during the competition flights. The Technical Commission will advise and inform the International Jury on any points of technical importance.

**1.4. Administrative Arrangements**

**1.4.1. Entries**

- 1.4.1.1 Every NAC must be notified of the address of the organiser for World Championships not later than 6 months prior to the beginning of the event. (See 1.2.1.1 or 1.2.1.3).
- 1.4.1.2 Entries (including for H/C pilots) may be submitted by NACs' authorized representatives only, with the exception of FAI applicants from countries without a NAC.
- 1.4.1.3 The official entry forms must be completed correctly and submitted to the organising aeroclub not later than requested by the organisers.

**1.4.2. Entry Fees**

- 1.4.2.1 Every National Airports Control sending a team or solo pilot or officials to World or Continental Championships must pay an entry fee for each member of the official team, solo competitors and officials (except judges and warm-up pilots) to the organising Aero Club.
- 1.4.2.2 Entry fees will be fixed by CIVA on agreement with the organisers.
- 1.4.2.3 The organiser will notify NACs of the date of payment and of the receiving agency.
- 1.4.2.4 Entry fees will be refunded if the World Glider Aerobatic Championships do not take place.

**1.4.3. Accommodation, Food and Medical Services**

- 1.4.3.1 At World Championships the organisers will provide adequate accommodation and food for the duration of the event to all members of official teams, solo competitors, officials and other assistants for whom entry fees have been paid, on the understanding that no extra charges will be imposed for those services. In addition, airfield charges and other fees for installations on the airfield will be covered by the entry fees for the persons concerned.
- 1.4.3.2 The organisers may also choose to exclude the costs for accommodation and food from the entry fees. In any event, they will give assistance with room reservation and will ensure that adequate food supply will be available at or near the airfield.



- 1.4.3.3 The organisers will be responsible for adequate medical services being available to all official participants.

**1.4.4. Towing Aircraft and Crews**

- 1.4.4.1 The organisers must make available towing aircraft and crews who are duly qualified and trained for this purpose.
- 1.4.4.2 The availability of at least two towing aircraft in service and one standby aircraft must be guaranteed. The performance of towing aircraft must meet the requirements of take-off sequence as shown under 3.8.1.1.
- 1.4.4.3 Towing fees for competition and training flights may be charged separately.

**1.4.5. Warm-Up Pilots**

- 1.4.5.1 The International Jury shall be responsible for selecting, several months prior to the event, at least one suitably qualified, non-competing Warm-Up pilot whose sole duty throughout the duration of the event will be to carry out demonstration sequence flights as specified in this document or required by the Chief Judge or the International Jury.
- 1.4.5.2 The International Jury shall ensure that experience and capabilities of pilots selected for this duty match the demands of the task. Thus, a suitable Warm-Up pilot must have appropriate and current aerobatic experience in the category specified, be able to provide or secure the use of a suitable glider which he/she is qualified and eligible to fly and be ready and available to fly at any time throughout the duration of the event. The International Jury will only consider applications fulfilling these requirements.
- 1.4.5.3 Applications may carry options on final name to cater for cases where national team members are selected late. In such case the application shall mention all names of potential applicants, and all pilots in the application shall fulfil the requirements in paragraph 1.4.5.2 above, otherwise the whole application will be rejected.
- 1.4.5.4 The type of glider to be flown by each Warm-Up pilot should be those in typical use at the event, able to perform in skilled hands at the highest level.
- 1.4.5.5 In case of unanticipated non-availability of a selected Warm-Up pilot, the International Jury has full flexibility to select a substitute in the best interest of CIVA.

**1.4.6. Technical Services**

- 1.4.6.1 The organiser will provide technical assistance and hangar space for the competing aircraft, if required.

**1.4.7. Interpreters**

- 1.4.7.1 Interpreters for the official language(s) of the contest, working together with the International Jury and the Board of Judges, will be provided by the organisers. The official language(s) must be stated in the Local Regulations.

**1.5. Final Regulations**

**1.5.1. Interpretation**

- 1.5.1.1 International aerobatic events will be carried out in compliance with the FAI Sporting Code and local regulations of the organisers.



- 1.5.1.2 Any differences arising during an event will be dealt with by reference to the above rules. For the interpretation of the text at championships, a standard version written in one of the official FAI languages (English, French, Russian, Spanish) shall be taken as the authority. CIVA will select one of the FAI languages as the basis for interpretation.

**1.5.2. Competitors' Pledge**

- 1.5.2.1 All competitors undertake, by signing the entry form, to comply with the General Section and Section 6 of the FAI Sporting Code and any local regulations made under rule 1.5.3.

**1.5.3. Supplementary Rules**

- 1.5.3.1 The organisers will, within the scope of the FAI Sporting Code and the approval by CIVA, prepare such local regulations or specialized details as are relevant and necessary for clarification of organisational problems and duly distribute them to all FAI National Air sport Controls (NACs) (see 1.2.1.1, 1.2.1.2 and 1.2.8).
- 1.5.3.2 The technical and organisational preparations of World Championships will be checked by CIVA regarding their compliance with the general rules before the beginning of the event.
- a) Not less than 6 months prior to the World Championships, the organisers shall publish in the agreed FAI language(s) and send to National Air sport Controls which have indicated a preliminary intention to participate:
- i) The local regulations containing only local operating procedures and administrative details including details of the aerodrome at which the Championships will be held.
  - ii) An English translation of applicable rules issued by the Aviation or Customs Authorities of the host country.
- 1.5.3.3 Organisers must ensure that at the time of the formal opening of the championship all technical preparations are completed and all required personnel are available.
- a) Should the organisers wish to request a waiver on any of the applicable rules in this document (FAI Sporting Code Section 6, Part 2) before the opening of the championships, they shall submit a waiver application to the CIVA Bureau and to the president of the International Jury with sufficient notice. The CIVA Bureau will then decide to grant or dismiss the waiver based on the submitted elements. Only an explicit positive answer from the CIVA Bureau will determine a waiver has been granted. In such case any waived rule shall be announced in the Championships Bulletin and sent without delay to the NACs which have indicated an intention to participate.



**2. PROGRAMMES FOR WORLD CHAMPIONSHIPS**

**2.1. Sequence of Programmes**

2.1.1.1 The Championship consists of the following six programmes:

- a) Known Programme (Programme 1)
- b) Unknown Compulsory 1 (Programme 2)
- c) Free Programme (Programme 3)
- d) Unknown Compulsory 2 (Programme 4)
- e) Unknown Compulsory 3 (Programme 5)
- f) Unknown Compulsory 4 (Programme 6)

2.1.1.2 The above sequence of programmes is mandatory. Any changes due to weather or other compelling reasons must be authorised by the International Jury.

2.1.1.3 If there is insufficient time to fly all six programmes due to weather or technical reasons, the International Jury is authorised to introduce a cut for the last programme up to a maximum of 50% of the competitors, based on the combined standings up to this programme.

2.1.1.4 If weather conditions or technical reasons prevent the completion of all the six programmes, at least 3 programmes must be completed for the event to be valid as a World Championship.

**2.2. Free Known (Programme 1)**

2.2.1.1 Sequences for the Free Known Programme will be composed of figures or combinations of figures (a combination being taken as one figure) selected from the Aresti System (Condensed) as follows:

- a) Five (5) figures from a Known 'master set' selected at the CIVA plenary each year for each category. The five Known figures will be identified by letters "A" through "E" on all sequence forms for Programme 1.
- b) Plus five (5) Free figures that each competitor must add in order to design a sequence of ten (10) figures that satisfies regulations below.

2.2.1.2 The selected Known 'master set' must be such as to enable competitors to fly all figures safely in the aircraft available to them, provided that the aircraft meet the requirements of category "A" certification.

2.2.1.3 The total difficulty coefficient of all figures of Free Known sequences shall not exceed the limits given in the table below.

|           | Known set<br>Minimum Total K | Known set<br>Maximum Total K | Sequence<br>Maximum Total K |
|-----------|------------------------------|------------------------------|-----------------------------|
| Unlimited | 115                          | 127                          | 230                         |
| Advanced  | 87                           | 97                           | 175                         |

2.2.1.4 Catalogue numbers may only be used once, except for horizontal lines (Family 1.1.1) and aileron rolls (Family 9.1). For Advanced contests the restrictions of paragraph 1 also apply to the Free figures.



2.2.1.5 Coefficients:

The final sum of figure K-factors must not exceed the amount of 230 ("AG" 175) for 10 figures total. The sum of the figure K-factors may be as large as 233 ("AG" 178) but will be reduced to 230 ("AG" 175), starting with the highest value Free figure, by removing one point from the highest K-factor Free figure that has not had a point removed. The K-factors of the five Known figures must not be reduced. In the sequence forms the original K-factors will be shown as well as the reduced values.

2.2.1.6 Versatility "UG"

Free Known sequences must contain at least one figure each from Family 2 and Families 5 through 8 of the Aresti Catalogue (Condensed), Glider Version, along with four roll elements from Family 9.

Specific requirements are:

- a) From Family 2 (turns and rolling turns) at least one rolling turn with one full roll.
- b) From Family 9 (rolls and spins) at least:
  - i) One half aileron roll (Family 9.1)
  - ii) One hesitation roll of any extent (Families 9.2, 9.4 or 9.8)
  - iii) One half positive flick roll (Family 9.9)
  - iv) One half negative flick roll (Family 9.10)

2.2.1.7 Versatility "AG"

Free Known sequences must contain at least one figure each from Families 5 through 8 of the Aresti Catalogue (Condensed), Glider Version, along with two roll elements from Family 9.

Further options and requirements are:

- a) A 90° inside rolling turn (Cat. No. 2.1.3.1) may be added. A 90° outside, or other rolling turns are not allowed.
- b) The elements from Family 9 (rolls and spins) must comprise at least:
  - i) One half aileron roll (Family 9.1).
  - ii) One hesitation roll of any extent (Families 9.2, 9.4 or 9.8).

2.2.1.8 The beginning of a Free Known sequence can be in upright or inverted flight, and the competitor is free to start in any direction, but it must be finished in upright flight.

2.2.1.9 Sequence Submission

Not earlier than one month prior and not later than one week before the official opening of the contest, each competitor must submit a computer file of his Free Known sequence in an acceptable format to the Contest Director for verification of compliance with the relevant rules. Hard copies alone or hand drawings will not be accepted. The computer file must contain complete pages for forms "A", "B" and "C" as well as forms "L" and "R". The competitor is responsible that the software used has been updated to comply with the Aresti System (Condensed) and Section 6, Part 2 regulations as currently amended by CIVA. Any pilot who has not submitted their Free Known sequence by the above deadline will not be allowed to take part in Programme 1.

2.2.1.10 For graphic presentation of aerobatic sequences CIVA allows the use of two different formats: Forms "A", "B" and "C" or Forms "L" and "R". Both Visio-Aresti and OpenAero software produce sequence forms in either format. Each judge decides which of both types they want to use. The Chief Judge passes a consolidated decision list on to the Organizer for sorting out the paperwork.



- a) Form "A" is a table showing all figure symbols, catalogue numbers, K-factors and Known Figure identification letters.
- b) Form "B" is a graphic depiction of the continuous sequence as it would be flown with the wind blowing from right to left, plus a table listing the figures, their catalogue numbers and K-factors.
- c) Form "C" depicts the continuous sequence as it would be flown with the wind blowing from left to right.
- d) Forms "L" and "R" show the sequence diagram and all required data with the wind from either left or right on one sheet each.

#### 2.2.1.11 Checking

- a) It shall be the duty of the organiser's officials to check each competitor's sequence validity:
  - i) correct use of the Known 'master set', non-repetition and versatility requirements.
  - ii) catalogue reference numbers and K-Factors on Form A (respectively R and L) with respect to the symbols on Forms B and C (respectively R and L), taking the reference numbers in the Aresti System (Condensed) as the basic criteria for deciding compliance with the rules of this section.
- b) The final responsibility for accuracy and conformance of Forms A, B, C or L and R lies with the competitor. Any inaccuracies in the drawing of symbols, in the quoting of K-factors or any cases of repetition of catalogue numbers will be referred to the competitor's Team Manager so that the sequence may be corrected and resubmitted.
- c) The organiser will provide hard copies to each competitor at time of registration for signature and those signed hard copies will be the ones used by the organiser for reproduction in accordance with para 2.2.1.13

2.2.1.12 Should a competitor disagree with a decision of the Contest Officials concerning his or her Programme 1, a complaint may be put to the International Jury before flying commences in Programme 1. The approved programmes of all competitors will be published before the start of Programme 1 in sufficient time for complaints and protests to be made. Once the flying of Programme 1 has started, no complaints of any kind will be accepted by the International Jury on any aspect of the composition of a competitor's programme.

2.2.1.13 The organisers will be responsible for reproducing a sufficient number of copies of competitors' sequences to meet the contest requirements. One copy of Form B of all Free Known sequences shall be provided to each Team prior to the start of Programme 1. The relevant set (A/B/C or R/L) shall be delivered to each judge in time to study the sequences according to para 4.1.2.5.

### **2.3. Unknown Compulsory and Free Programmes (Programmes 2 through 6)**

#### **2.3.1. Figure Selection**

2.3.1.1 For Programmes 2 through 6, figures will be chosen separately for each Programme from Appendix A. A total of 7 figures must be selected. A representative of every NAC which has a pilot (or pilots) competing (except as *Hors Concours*) may submit one figure, unless there are more than 7 NACs participating.

2.3.1.2 If there are pilots competing from more than 7 NACs, 7 such NACs will be selected to nominate figures for each Unknown Programme. Lots will be drawn, supervised by the international jury, to determine which NAC, s shall choose figures and in which order.



2.3.1.3 If there are pilots from fewer than 7 NACs participating, their representatives will still select only one figure each. The remaining figures will be selected by the International Jury. These figures must cover Families not already represented (if any). Repetition of Catalogue numbers is not allowed throughout the nominated figures.

2.3.1.4 The 7 selected figures must comprise:

| Family      | Advanced     | Unlimited   |
|-------------|--------------|---|
| 2           |              | at least one rolling turn   |
| 5 or 6      | at least one | at least one  |
| 9.9 or 9.10 |              | at least one full or two half flicks;<br>not more than one flick per figure;<br>not more than three flicks with 720<br>degrees total rotation |

- a) UNLIMITED: - minimum K for each figure 17 - maximum K 43 - the total K-Factor of the first 3 selected figures may not be more than 110. - total K for the 7 figures: minimum 180, maximum 200
- b) ADVANCED - minimum K for each figure 10 - maximum K for each figure 37 - total K for the 7 figures: minimum 150, maximum 170
- c) Repetition of (any manoeuvre with) the same catalogue number is not allowed within any one Programme except Families 1.1.1 and 9. Repetition of complete figures from previous Programmes is not allowed in subsequent Programmes (except Families 5 and 6 "AG" only).

2.3.1.5 Figures shall be selected taking into account the flight characteristics and operating limits of competing gliders and the safety of all pilots. If the representative of a team or an individual competitor is able to show within 30 minutes from the completion of figure selection that a selected figure may exceed the operating limits of competing gliders, the International Jury will ask the team which proposed this figure either to replace or modify it. After this time (30 min.) the figure selection is considered final.

2.3.1.6 If it is obvious that with the proposed figures no reasonable sequence can be composed, the jury will ask NACs to modify their figures accordingly. If none of the NAC is willing to change their proposed figures, the International Jury is entitled to make the decision.

2.3.1.7 If gliders like SZD-59 Acro, MDM 1 Fox or gliders with comparable characteristic and performance participate in a contest, the representative limitations in figure selection for Programmes 2 to 6 apply as stated in appendix A.

### **2.3.2. Sequence Submission**

2.3.2.1 Teams will submit sequences using the 7 figures officially selected. One or two linking figures from the current Aresti System (Condensed) Glider Version must be added. The K-Factor of the linking figures is 5 K each for two figures or 10 K for one figure. In sequence composition, figures may be used starting from one or the other axis. Nevertheless, figures with their entry and exit on the same axis must maintain their construction as submitted, i.e. with the exit flight path in the entry direction or with the direction of flight reversed as originally drawn. "AG" Sequences must be finished in upright flight.



2.3.2.2 The Contest Director will announce the deadline for submitting sequences. Proposals must contain complete pages of all five forms A, B and C as well as L and R. Computer files must be submitted, using a CIVA-approved software.

**2.3.3. Unknown Compulsories (Programmes 2, 4, 5 and 6)**

2.3.3.1 Selection and Publication of Unknown Compulsory Sequences:

- a) The International Jury will select one of the submitted sequences for use.
- b) The International Jury may alter the selected sequence if necessary for safety reasons.
- c) Chief Delegates or their representatives may object to the published sequence within one hour after publication for safety reasons only. In this case, the International Jury will modify the sequence in order to remove the objection without changing the figures selected under rule 2.3.1.4
- d) If it is found that the sequence selected cannot be safely flown within the height available, the International Jury may delete one figure, consulting the Chief Delegate of the NAC which proposed this figure.
- e) Sequences, after having been approved by the Chief Delegates or their representatives, will be announced to competitors by the International Jury not later than 12 hours before the scheduled start of each programme.

**2.3.4. Free Program (Programme 3)**

2.3.4.1 The contest Organiser shall provide copies of the list of figures to all competing NACs.

For each Programme, each competitor shall submit his/her own sequence to the International Jury composed of these figures and will fly that sequence. The contest Organiser will determine the deadline for submitting sequences. Hard copies alone or hand drawings will not be accepted. The computer file must contain complete pages for forms "A", "B" and "C" as well as forms "L" and "R". The competitor is responsible that the software used has been updated to comply with the Aresti System (Condensed) and Section 6, Part 2 regulations as currently amended by CIVA. Any pilot who has not submitted their Free Program sequence by the above deadline, will not be allowed to take part in the Free Programme (Programme 3)

All sequences received by the deadline must be checked by the International Jury and corrected by the competitor if necessary.

At least 1 hour before the start of each Programme, the Organiser shall provide each NAC with a list of the Free Unknowns from each competing pilot.

2.3.4.2 Prior to the commencement of each competition flight, the Chief Judge verifies by radio with the competitor the sequence to be flown. Example: "Competitor 5 radio check and confirm sequence 5".

**2.4. Allowed Figures "AG"**

Except for the following restrictions, all the figures from the Aresti Catalogue (Condensed), Glider Version, may be flown.

- a) No full negative loops. No high-speed negative part-loops of more than 45° (1/8th loops).
- b) No rolling turns, except catalogue No. 2.1.3.1 in program 1 / Known, as figure added by the competitor according § 2.2.1.1. b)
- c) No rolls vertically up. No more than 1/4 roll vertically down. No flick rolls, positive or negative. No inverted spins.



**2.5. Super-Slow Rolls**

Super-Slow Rolls (Family 9.13) are not flown in international glider aerobatic contests.

**2.6. Coefficients for the Programmes "UG"**

| <b>Programmes</b>                               | <b>1</b>       | <b>3</b>               | <b>2, 4, 5 and 6</b>   |
|---|----------------|------------------------|------------------------|
| Total coefficient of figures                    | 230K<br>(233K) | max. 210K<br>min. 190K | max. 210K<br>min. 190K |
| Positioning (Electronic tracking system in use) | 15K            | 15K                    | 15K                    |
| Positioning (marked by Judges only)             | 25K            | 25K                    | 25K                    |

**2.7. Coefficients for the Programmes "AG"**

| <b>Programmes</b>                               | <b>1</b>       | <b>3</b>               | <b>2, 4, 5 and 6</b>   |
|---|----------------|------------------------|------------------------|
| Total coefficient of figures                    | 175K<br>(178K) | max. 180K<br>min. 160K | max. 180K<br>min. 160K |
| Positioning (Electronic tracking system in use) | 15K            | 15K                    | 15K                    |
| Positioning (marked by Judges only)             | 20K            | 20K                    | 20K                    |



### **3. THE ORGANISATION OF WORLD GLIDER AEROBATIC CHAMPIONSHIPS**

#### **3.1. Briefings**

- 3.1.1.1 Prior to beginning of a contest there will be a briefing by the organisers for Chief Delegates or Team Managers, members of the International Jury and the Judges on flight conditions, the contest programmes and any other problems which might arise over the interpretation of the rules.
- 3.1.1.2 Prior to beginning of competition flights on each competition day, a briefing will be held for Competitors, Officials, Judges, and the International Jury on organisational matters, concerning the competition day, meteorological conditions, etc. The briefing should last no longer than 30 minutes.

#### **3.2. Familiarisation Flights**

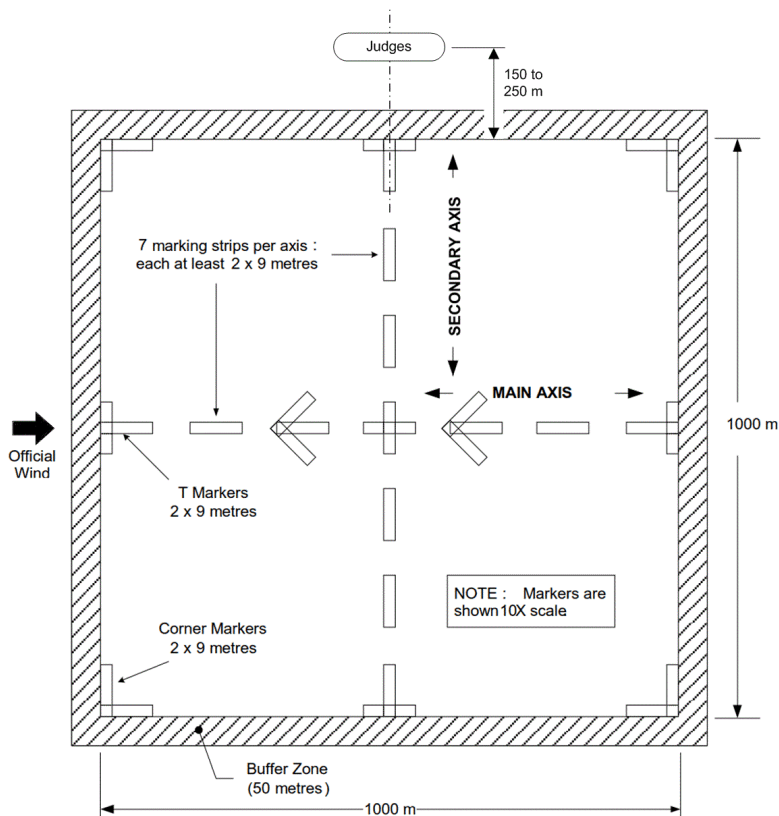
- 3.2.1.1 Each competitor at World Championships, timely arrival provided (minimum one day), will be given the opportunity to make at least one flight over the marked performance zone for familiarisation with the local conditions. Organisers should offer a minimum of three days for familiarisation flights and plan to hold judges' briefings and practice judging sessions during this period. Familiarisation flights must be completed prior to the formal opening of the championship.
- 3.2.1.2 Familiarisation flights are subject to the same safety regulations and minimum heights as contest flights and will be conducted according to a starting list produced by the organiser.
- 3.2.1.3 For familiarisation flights, Visual Flight Rules (VFR) of the organising country must be observed, but contest weather minima as specified in Section 0 need not be fulfilled.
- 3.2.1.4 No further training flights are allowed after the start of the championship. In case of violations there will be penalties or disqualifications. The International Jury may authorise additional familiarisation flights after the opening of the contest for weather or other compelling reasons.
- 3.2.1.5 If it is necessary for purposes of media coverage, competitors may be authorised to fly a demonstration programme which must be approved by the International Jury, the Chief Judge and a two-thirds majority of the Chief Delegates.

#### **3.3. Sequence of Flights (Drawing of Lots)**

- 3.3.1.1 The sequence of flights for all Programmes will be determined by drawings of lots.
  - a) The Organiser shall, with sufficient notice, submit the set-up of the drawing of lots (items to be drawn, position and clarity of the hidden numbers on items, etc.) to the international jury for approval.
  - b) Prior to the drawing of lots, the Organiser shall give the approved items ready for the drawing of lots (i.e. with the number on each item, which will not be visible when drawing of lots) to the international jury, together with any material needed as approved under a) above.
  - c) The international jury will then set up the items for the drawing of lots, with an appropriate shuffling ensuring random drawing.
  - d) Each competitor will draw his or her own lot in front of attendees during the briefing, under supervision of the international jury. If a competitor is not present to draw his or her own lot, a member of that competitors' team may do so.
- 3.3.1.2 The sequence determined by lot may be altered with the approval of the International Jury if special circumstances require (e.g. use of the same glider by different competitors). The first three places must not be altered for the Unknown Compulsory Programmes. After any drawing of lots, the first competing pilot should have an allowance of one hour between drawing of lots and taking off.

**3.4. Performance Zone**

- 3.4.1.1 Programmes will be flown with reference to the longitudinal and lateral axes marked on the ground. The performance zone will be a clearly and distinctly marked area of 1000 x 1000 m, the central point of which will be the intersection of the axes. The performance zone must be situated close to the airfield (runway).
- 3.4.1.2 The longitudinal (main) and the lateral (secondary) axes shall be marked by 7 contrasting marking strips. The size of these markers must be at least 2 x 9 m, with the long side aligned with the direction of the axis. The end of the axis and the 4 corners of the box must be clearly marked. Two arrows will be placed near the central point of the main axis. They indicate the specified direction of the main axis pointing into the Official Wind. The International Jury will determine any change of the Official Wind Direction as may be necessary and arrange for the shifting of the direction arrows (see 3.7.1.4b)).
- 3.4.1.3 The colour of the marking strips must be in distinct contrast to the ground and other airfield markings, which should be removed if necessary.
- 3.4.1.4 Aerial pictures of the box, taken along both axes, must be distributed to the International Jury and competing Teams to determine the correctness of the box geometry and to facilitate familiarization with the physical references.
- 3.4.1.5 The aerobatic performance zone:





### **3.5. Warm-Up Flights**

- 3.5.1.1 The Organisers will ensure that at least the first flight of each contest day and each programme will be by a non-competing pilot.
- 3.5.1.2 Prior to each flight the Warm-Up pilot should seek instruction from either the Chief Judge or a member of the International Jury regarding the demands of the flight itself. The Chief Judge may also request some specific deliberate 'errors' to be included in the flight for the purpose of exploring the attention and discrimination of the panel of judges.

### **3.6. Video / Audio Devices**

- 3.6.1.1 Video cameras may be mounted in/on competition aircraft at the discretion of the pilot.
- 3.6.1.2 Radio sets are required and must be able to be tuned to the "Safety Frequency". No other audio devices are permitted and will either be removed from the competing aircraft or rendered inoperative and sealed by the Technical Commission.
- 3.6.1.3 Receiving any kind of audible information addressed to the competitor from anyone other than the Chief Judge or Air Traffic Control will render the competitor liable to disqualification from the contest.
- 3.6.1.4 Failure of a competitor's radio after arrival at the contest site will not be grounds for disqualification. The contest Organiser will arrange other means for the safe and orderly dispatch of these pilots.
- 3.6.1.5 The Safety Frequency will be selected by the Organiser and given to the competitors together with the competition papers. The Safety Frequency will be monitored during all competition flights and possibly recorded.
- 3.6.1.6 Once each pilot is airborne, they are not allowed to enter the Performance Zone before two-way communication is established with the Chief Judge. The Chief Judge will call the competitor on the safety frequency, saying: "Number x, radio check". If the pilot does not receive this call, after a reasonable time and visually checking that no other aircraft is flying in the Performance Zone, they should call the Chief Judge on the safety frequency and state, "Number x, radio check." The Chief Judge must respond to this call if he hears it. If two-way communication is not established, the pilot must land immediately. The situation will then be treated as in the case of any other technical defect in accordance with section 3.11.
- 3.6.1.7 The standard phraseology in the event that a break is required for safety reasons will be the Chief Judge saying "Break, break, break". The pilot must then stop aerobatic manoeuvring immediately and return to upright level flight. After that, the pilot should land as soon as practicable. The Chief Judge or his representative may address the competitor in matters concerned with safety of the competition flight as circumstances may require. A pilot who fails to comply with any of these instructions from the Chief Judge shall be liable to disqualification from that Programme.



**3.7. Meteorological Conditions**

3.7.1.1 Competition flights will be carried out between sunrise and sunset at the place of the competition. If weather conditions deteriorate within this time, the International Jury, in consultation with the contest management, will decide upon the start and finish of competition flights.

3.7.1.2 The following meteorological conditions are needed:

- a) The performance zone must be free of clouds.
- b) The flight visibility, determined with reference to ground features from the midpoint of the performance zone at the release height for the competition flight just taking place, must be a minimum of 5 km.
- c) The maximum permissible average wind speed components are:

| <b>Altitude</b> | <b>Direction</b>               | <b>Maximum Permissible</b> |
|-----------------|--------------------------------|----------------------------|
| <b>Surface</b>  | Any                            | 10 m/s                     |
|                 | Crosswind (ref. runway)        | 5 m/s                      |
|                 | Tailwind (ref. runway)         | 3 m/s                      |
| <b>700m</b>     | Headwind (ref. box main axis)  | 10 m/s                     |
|                 | Crosswind (ref. box main axis) | 5 m/s                      |
| <b>1200m</b>    | Tailwind (ref. box main axis)  | 3 m/s                      |

If the contest is significantly delayed due to unfavorable weather and there is a serious risk that the minimum number of Programmes (3) may not be completed in time, the limit for the headwind in the performance zone may be raised to 12 m/s without exceeding a crosswind component of 7 m/s subject to the following provisions:

- i) Unanimous decision by the International Jury
- ii) Agreement of the Contest Director and the Chief Judge

This decision is to be taken independently for each Category (Advanced and Unlimited).

- d) The performance zone must be free of precipitation (see also 3.7.1.9b)).
- e) The performance zone must be free of strong turbulence (see 3.7.1.8); this does not apply to occasional thermals.
- f) Visual Flight Rules for the organising country, including any special competition rules, have to be observed.

3.7.1.3 The International Jury decides if the weather conditions exist according to paragraph 3.7.1.2. In the case of doubts about adequate meteorological conditions, or if at least two Team Chiefs inform the International Jury that weather requirements are not met, the following procedures apply:

- a) The members of the International Jury should use an aircraft to be made available for this specific purpose and arrange for a weather reconnaissance flight.
- b) If competition flights are in progress, in order to establish the actual weather conditions the next pilot of the towing aircraft will get flight orders by the Jury for a weather report containing all of the required data. The towing aircraft will first cross the performance zone at roughly the release

altitude. The competitor will be informed by radio about the purpose of this procedure. The glider pilot will not release during this first towing procedure. If the meteorological conditions are sufficient, the glider will be towed a second time through the performance zone. From this moment regulations according to 3.9.1.2 apply. If the towing aircraft pilot considers meteorological conditions not to be sufficient, and if the Jury decides to cancel the current flight, the competitor will be informed via the "Safety Frequency" or according to the "No-Radio Procedure", and he must release and land without delay, and without performing any aerobatics.

- 3.7.1.4 The Contest Director provides the competitors, the Chief Judge, the Board of Judges, and the International Jury with hourly information on weather conditions or at shorter intervals if required by meteorological development. This must include average wind speed and wind direction on the ground and in the performance zone at 700 m and 1200 m height along with the Official Wind Direction as determined by the International Jury. In case the maximum height is less than 1200 m, wind speed and direction must be measured at the upper height limit for the current programme. The weather bulletin with current information on wind speed and direction will be published on a board at the flight line. The bulletin must include the time of the measurement as well as the publication time. The Team Managers are responsible for passing those data on to their teams.
- a) Winds aloft must be measured in or near the performance zone using an approved method with sufficient accuracy e.g. balloon ascent, radar, airborne GPS or drone systems.
  - b) The International Jury shall provide the Official Wind Direction to the Chief Judge and Contest Director before the start of each contest day and any time it is determined that the Official Wind Direction must be changed. The decision with regard to the Official Wind Direction – always aligned with one of the performance zone axes – must take into account the predominant direction of the actual prevailing wind. Any change of the Official Wind Direction must be published within 30 minutes from the time the change was determined.
  - c) When light winds prevail (i.e. less than 5 m/s) it shall be at the discretion of the International Jury not to change the Official Wind Direction, even though the wind direction may be more than 45° off the axis, in order to avoid frequent changes during the day.
  - d) Under stable weather conditions, adequately meeting the above conditions, hourly information is not required. The International Jury will decide upon the necessity of providing this information.
- 3.7.1.5 The Flight Director, after consultation with the International Jury, will discontinue competition flights if meteorological conditions deteriorate below the minima of paragraph 3.7.1.2. Such decision may be taken:
- a) If measured upper winds are out of limits.
  - b) If the visibility is judged independently by members of the International Jury, the Chief Judge, tow pilots or competitors to be below the minimum.
  - c) If there are clouds or precipitation in the performance zone.
  - d) If competitors or tow pilots report excessive turbulence.
- 3.7.1.6 If one of the weather conditions deteriorates to less than the minimum during a run and if the Jury decides on an interruption of the contest flights, the Flight Director must be informed immediately. If a competitor is being towed, they will be informed via the "Safety Frequency" or according to the "No-Radio-Procedure", whereupon they have to land without delay.
- 3.7.1.7 If the height of release of 1200 m (over datum) is not available due to clouds in the performance zone, but if there are at least 750 m available, the International Jury may cancel the first and/or the last



figures of a compulsory programme and have the shortened programme flown or split the programme. The procedure is as follows:

- a) If the cloud base within the performance zone sets to below 1200 m (over datum) and if the Jury decides to cut a compulsory programme or to split a programme, the pilots must be first advised at a briefing.
- b) If a programme is cut, marks for the omitted figures will be cancelled for the pilots who have flown under normal weather conditions. If a programme is split, the scores of those competitors who have flown the continuous programme will remain unchanged.
- c) If the cloud base rises to 1200 m (over datum) during a split programme, competitors must fly their full programmes without interruption after the Jury has so instructed and if during the tow normal weather conditions prevail in the performance zone (according to the tow pilot's report).

3.7.1.8 The limit for turbulence in the performance zone (see 3.7.1.2) is +2 G (vertical acceleration). The strength of the turbulence will be determined by five consecutive straight penetrations through the performance zone at 200 km/h at different altitudes. The flight must be conducted by a member of the International Jury or a non-competing pilot appointed by the International Jury, as required, at intervals of not less than half an hour. The flight should be made with an aircraft whose wing loading is comparable to that of the lightest competing aircraft. A common G-meter with limit needles is to be used.

3.7.1.9 Adverse Weather

- a) If in the opinion of a competitor the weather conditions do not comply with competition rules, they may not start their competition flight and land. If the competition flight is started, a repetition of the flight or parts of the flight due to insufficient meteorological conditions is not possible, except if rain can be proven as the reason for the breaking off of the flight. For the repetition of the flight in such a case see 3.11.1.8.
- b) When a pilot encounters rain after release from tow, either before or during the execution of the programme, they may break off their flight and land immediately. The competitor must bring evidence, so they must inform the start line by radio or immediately after landing. In the case where rain cannot be confirmed by a tow pilot or contest officials on the ground (member of the International Jury or a member of the Technical Commission) they must show that the aircraft is wet immediately after landing.





### **3.8. Conduct of Competition Flights**

- 3.8.1.1 The competitors will start in the predetermined sequence. The intervals between releasing will be individually decided by the Chief Judge and will be adapted to the appropriate situation, in order to grant quick continuation. In Compulsory Programmes eight minutes and in Free Programmes ten minutes can be taken as a guide.
- 3.8.1.2 No flight shall be required to commence within a period of 30 minutes after the Official Wind Direction is determined or subsequently changed.
- 3.8.1.3 A competitor must signal the start and finish of each programme by distinctly dipping the wing three times by more than 30 degrees. If the first figure in a programme begins in inverted flight, the first two wing-dips may be in upright flight, and the last wing dip must be performed in inverted flight. The competitor may change the flight attitude from normal to inverted only by a half roll prior to the last wing-dip. A horizontal flight path is required before the start of the first figure, and the last wing-dip must be in horizontal flight. (see 4.4.6). Pilots shall land immediately at the end of a competition flight.
- 3.8.1.4 Any competitor required to interrupt a competition flight due to danger of collision with conflicting air traffic or a bird, should be treated in the same manner as if a mechanical defect (paragraph 3.11) had taken place.
- 3.8.1.5 There will be, if required, a 30-minute break after every two hours of competition flying for the Board of Judges to have a rest.

### **3.9. Height Limitations**

- 3.9.1.1 The following height limitations have been determined for all contest flights:
- a) Upper limit: 1200 m (over datum)
  - b) Upper limit: 750 m (over datum) in a split programme
  - c) Lower limit: 200 m (over datum)
  - d) In level terrain the datum will be taken to be the elevation of the airfield. In uneven terrain the datum will be the highest point found under the performance zone. The elevation will be rounded off to 50 m; for example, a height difference of 25 m above the field will be ignored.
- 3.9.1.2 Cable Release
- a) The cable release height is at the upper height limit. Tow planes must be equipped with either barographs or loggers. Barograms or logger data must be made available for the International Jury on request.
  - b) The competitors determine their point where they release. The tow plane will tow in the direction of the principal axis at 1250 m (over datum) with constant airspeed through the performance zone. The release altitude is 1250m, with or without the HMD. The height and direction will be established one km before entering the performance zone. If the competitor does not release at the end of the performance zone, they will be towed in a second time in the same direction. They must release at the end of the second passage at the latest. The tow plane will indicate that requirement by rocking its wings.
  - c) For towing procedures with Height Measuring Devices see Appendix 0.



**3.10. No Radio Procedure**

- 3.10.1.1 If the competitor's radio is inoperative or instructions from the Chief Judge are not confirmed, the following signals from the towing pilot to the glider pilot are applicable:
- a) No release in the performance zone during the first pass: Significant rudder motion, at least 0.5 km prior to reaching the performance zone.
  - b) Release followed by landing without delay and without performing aerobatics: Significant wing rocking at least 0.5 km prior to reaching the performance zone.

**3.11. Measures in Case of Mechanical Defects**

- 3.11.1.1 In the event of a competing glider becoming unserviceable before the start of a flight, the International Jury may, on the recommendation of the Technical Commission, permit the competitor to use another glider or the same glider following the removal of the defect. In case of the use of a different glider, the participant may conduct test flights, where the reaction of the glider may be tested. The manoeuvres to be flown are to be discussed with the International Jury beforehand. The International Jury will determine the number of test flights, considering the requirements of flight safety.
- 3.11.1.2 In the event of a competitor breaking off his competition flight in case of technical damage which is beyond the pilot's control after takeoff, he may be allowed to repeat the flight, provided that evidence of the damage can be furnished to the Technical Commission within 2 hours after landing. For finding the damage only, the following persons will be permitted to work on the glider: the competitor and the mechanic named by the competitor, plus the members of the Technical Commission (except the one belonging to the pilot's Aero Club) and the International Jury. When the cause of the damage has been found, the damage will be repaired by the mechanic of the glider and other experts, as recommended by the Technical Commission. As the situation requires, a test flight may be conducted after a repair.
- 3.11.1.3 Any damage will be counted as such, provided it is a break or deformation found on parts of the glider without any special devices except magnifying glasses
- 3.11.1.4 The following defects will not be counted:
- a) incorrect adjustment,
  - b) technical trouble caused by dirt if attributed to negligence of the competitor or his team,
  - c) insufficient or missing safety devices causing a change of settings during the flight,
  - d) defect caused by the pilot exceeding the flight limits of the aircraft,
  - e) In the cases (a) to (d) the competitor will not be permitted to repeat his flight.
- 3.11.1.5 The International Jury must, not later than five hours from the landing of the competitor concerned, decide whether or not a repetition flight will be approved. In the case of doubt on the basis of the statement by the Technical Commission, the International Jury shall decide in favour of the competitor.
- 3.11.1.6 In order to avoid any delay in the progress of the contest, the flight will be repeated at the end of the current programme even if this is prior to the decision of the International Jury. In case of an illness or of a technical defect, the latest moment a competitor can repeat his flight is before the final scores of this Programme are to be published (see 4.6.3.2).
- 3.11.1.7 The sequence of repetition flights is determined by the sequence of interruptions of competition flights.
- 3.11.1.8 A competitor making a repetition flight must re-fly the entire programme. Judging and scoring will be continued from the figure during which the technical problem occurred in the interrupted programme.



3.11.1.9 In the event that a technical problem arises with an aircraft that prevents the continued participation of a significant fraction of the competitors, the International Jury may, after discussion with the Chief Delegates, declare the contest concluded. The nature of the technical problem must be confirmed by the Technical Commission.

**3.12. Protests**

3.12.1.1 Protests will be accepted from individual competitors and teams only. All protests must be submitted to the President of the International Jury in writing, either directly or through the Contest Director, with a deposit, not later than two hours after the occurrence, decision or publication of results which causes the protest to be made. "Non-working" hours, as defined in local regulations for the specific championships or competitions will not be counted. Every protest must refer to the rule or rules to which it relates. The amount of the deposit shall be stated in the local regulations for the championships or competition. It should not exceed 100 EUR.

3.12.1.2 All protests will be dealt with in compliance with the FAI Sporting Code, General Section, Chapter 6. They will be dealt with by the International Jury, in cooperation with the Chief Judge if his assistance is required and his duties permit. Decisions taken by the International Jury are final and must not be changed later.

3.12.1.3 The deposit will be returned if the protest is upheld.



#### **4. EVALUATION OF COMPETITION FLIGHTS**

##### **4.1. Evaluation of the Performance**

##### **4.1.1. The Chief Judge**

- 4.1.1.1 The Chief Judge's primary concern should be the accurate and fair judging of the competition flights, including the monitoring of flights for Hard Zero marks and penalties. He should place his expertise at the disposal of the Board of Judges, and coordinate and guide their work.
- 4.1.1.2 The Chief Judge oversees administrative matters (correctness of paperwork, recording of penalties, etc.) but must be provided with two Chief Judge Assistants under his supervision who will perform at least the following tasks along with other duties as requested:
- a) Calling the manoeuvres and recording the notes of the Chief Judge, to whatever extent he requires.
  - b) Processing and expediting the flow of paperwork.
  - c) Receiving and recording the calls of the Boundary Judges.
  - d) Handling all other radio communications. One of his assistants should assist in monitoring the zero marks and penalties awarded by the Judges after each flight.
- 4.1.1.3 The Chief Judge shall brief and direct a non-competing pilot nominated by the organisers to demonstrate the 'low' and 'disqualification' heights around the performance zone prior to the commencement of contest flying each day. This demonstration will normally comprise:
- a) Flight along the front boundary and the two main axes, dipping the wing above the T, s and the centre marker. and the centre points.
  - b) Flight along the two main axes, dipping the wing above the 'T's and the centre marker.
  - c) The Chief Judge should clearly announce to all judges the 'low' or 'disqualification' height being flown, and draw attention to the appearance of the demonstrating aeroplane with particular reference to:
    - i) Its proximity to the ground, to assist later assessments of low flying and
    - ii) Indications of the box boundary with respect to notable local / surrounding features, to provide a sound basis for assessment of the positioning mark.
- 4.1.1.4 It is essential that the Chief Judge follows each flight, with emphasis on recording hard zeros, insertions and height penalties. Such infringements and comments should be recorded, as an aide-memoire, on a score sheet which should be retained for reference prior to the judges score sheets being submitted to the workstation. The official recording of penalties will be on the appropriate section of the score sheet reserved for the use of the Chief Judge and entered prior to submission to the scoring system.
- 4.1.1.5 For familiarisation with and a standardised interpretation of the judging rules, the Chief Judge will hold seminars with the Judges and Team Managers or other Team Representatives and carry out at least one judging test, for which a non-competing pilot shall be available. However, this judging test can also be conducted during the familiarisation flights, in so far as the pilots give their intended flight programmes beforehand to the starter.
- 4.1.1.6 The Chief Judge will hold other routine evaluation meetings with the Judges during the contest. He should ensure that the Code of Practice is understood and operates smoothly and establish a good working relationship between teams of Judges and Assistants, Timekeepers, and other helpers.



- 4.1.1.7 The Chief Judge is responsible for ensuring that there is enough time between flights for the judging to be unhurried. He should control (by radio) the flow from one contestant to the next.
- 4.1.1.8 At the end of each flight, the Chief Judge should ascertain whether any of the Judges have recorded a Hard Zero (HZ) mark, height penalty, interruption penalty or "Behind judges" remark. This will be done by perusal of the score sheets collected from the judges, prior to entry into the scoring system.
- 4.1.1.9 When all Forms "A" or "L/R" have been submitted to the Chief Judge for a flight and difficulties occur in interpreting the correct application of the "HZ" mark or insertion penalty:
- The Chief Judge shall call for a discussion at the judging line with the International Judges.
  - Such discussions shall not interfere with the subsequent flights.
  - The official video may be used in these discussions to help determine matters of fact.
  - A Judge may request a viewing of the video during a discussion, if he deems it necessary. This request will always be honoured.
  - All Forms "A" or "L/R" shall be retained by the Chief Judge until the final decision is made.

#### **4.1.2. Judges**

- 4.1.2.1 CIVA Judges and Assistants, on being selected for duty on an International Judging Panel, must at all times act with true impartiality and treat all competitors on an equitable basis including during breaks in the competition. Any indication that a Judge or Assistant is acting contrary to the required manner and/or is seen to be colluding with a third party in matters that could affect their impartiality may lead to expulsion from the judging line, subject to review and confirmation of such a directive by the International Jury.
- 4.1.2.2 All Judges and Assistants are required to sign the CIVA declaration of ethical behaviour when registering at the event (see also 1.3.1.1c)ii).
- 4.1.2.3 Each programme of World Championships will be marked by the Judges using a standardised system (see Appendix B and also paras 4.1.4 and 4.5.1 below).
- 4.1.2.4 The marks given by a Judge to a pilot of his/her own country shall be included.
- 4.1.2.5 All Judges should study copies of all contestants' Free Known and Free Unknown sequences before flying of the programme is started.
- 4.1.2.6 A Judge may only reconsider his marks as long as his score sheet is still in his possession or if asked to do so at the request of the Chief Judge. Once entered into the scoring system, the scoring sheet comes under the jurisdiction of the International Jury. The judge himself must sign off any changes on the score sheet.
- 4.1.2.7 The preliminary flights by non-competing pilots (rule 3.5.1.1) will be marked exactly as if they were competitors; bearing in mind that the purpose of these flights is so that the first competing pilot who follows them shall not be penalised by receiving an unduly low "anchor" mark.
- 4.1.2.8 Judges must record as many comments on the score sheets as possible, with particular reference to significant errors. They may make these comments in any language or form, provided that they are able to explain the comments if required.
- 4.1.2.9 A judge will not make improper communication to third parties by means of cell phone, radio, or other device whilst on the judging line or during breaks/lunches. Failure to adhere to this instruction may lead to expulsion from the judging line.



- 4.1.2.10 The judges are advised to keep activities of the Board of Judges and of the International Jury strictly confidential.
- 4.1.2.11 In case of a vote among the Judges on the question of penalisation, all judges shall vote regardless of nationality.
- 4.1.2.12 Where the majority decision of the Panel of Judges is required, in a case of disagreement about the penalisation of the flight of a competitor, the Chief Judge shall have a casting vote in the event of a tie.
- 4.1.3. Recording of Insertions, Height Infringements, Infringements of the Performance Zone and improper Wing-Dipping**
- 4.1.3.1 Recording insertion penalties (4.4.3.1), infringements of the lower and upper height limits, infringements of the performance zone and awarding penalties under rule 4.4.6 concerning wing dipping at the start and end of programmes, will be carried out under the responsibility and control of the Chief Judge.
- 4.1.3.2 Each judge must record such infringements on their score sheet. Where there are no such infringements the words “No Penalties” or “NP” should be entered in the remarks box, thus giving a positive indication in either instance. The Chief Judge or his assistant will then enter the appropriate penalty based on the majority result. In the case of a 50/50 split the Chief Judge may call a conference or cast his vote as appropriate.
- 4.1.3.3 The awarding of penalties for infringements of upper and lower height limitations is decided by majority vote of the judges. In the case the required simple majority could not rise from a vote within the Board of Judges, the Chief Judge shall have the casting vote.
- 4.1.4. Marks for Figures**
- 4.1.4.1 The Judges will independently mark the quality of each figure and its components marking with numbers 0 to 10 in intervals of 0.5, using the point reduction system for each element of a figure as described under paragraph 4.5.1 and Appendix B. A Hard Zero (HZ) mark will be awarded if the figure is incorrect or missing, in accordance with paragraph 4.5.2.
- 4.1.4.2 The scores will be calculated by multiplying the coefficient (K) for each figure by the mark given to each.
- 4.1.4.3 When marking the quality of the performance of individual figures, the Judges have to consider the following general principles:
- a) Accordance of the figure flown and direction of flight, with the pre-stated figure in the original sequence.
  - b) the distinctly recognizable start and finish of each figure with a horizontal line.
  - c) that in judging a figure which comprises a combination of manoeuvres, the marking criteria of its various components continue to apply, but the combined manoeuvres are to be taken as a unit.
  - d) Marking Criteria are set out in Appendix B.
  - e) that the length of lines and the size of radii caused by the flying characteristics of an aircraft are not to be taken into account in the marking.
  - f) that inverted figures are judged by the same criteria as upright figures.
- 4.1.4.4 Once horizontal flight path is established at the end of a figure in a sequence, the beginning of the next figure is considered to have occurred.



- 4.1.4.5 If a judge misses seeing a figure, or any part of a figure, such that a mark cannot be given with full confidence, the Judge will give a mark of “Average” or “A” to that figure.
- a) When determining the Ranking Index (RI) for each judge, "A" marks will be replaced by a numeric average of the other judges (non-"A") marks (with HZ's evaluated as numeric zeros), evaluated to the nearest half-mark. In case the numeric average decimal part is exactly 0.25 or 0.75, the substituted mark will be the nearest higher half-mark.

#### **4.1.5. Marking of Positioning and Symmetry**

- 4.1.5.1 Positioning refers to the 3D placement of each figure relative to the performance zone and to the judges. A position mark will be given by each Judge.
- 4.1.5.2 A column headed “Pos” on the Form A (respectively R, L) marks sheet shall be used to record the positions of figures that are not optimally placed, as they are flown.
- 4.1.5.3 Depending on the aircraft's height and the nature of the figures, there is an optimum X and Y axis position for each figure where the requirements of the sequence are satisfied, and any geometric errors will be clear to the judge and therefore easy to assess. This position may be central or toward the right or left within the performance zone, and nearer to or further from the judge as dictated by the design of the sequence and the height and performance of the aircraft.
- 4.1.5.4 The position of a figure is somewhat or considerably “non-optimal” when it adversely affects the judge's ability to assess it, is poorly positioned when considered within the design of the sequence, or its position dictates that subsequent figures will not be flown at optimal positions and may therefore be difficult to assess. Otherwise, the position shall be considered satisfactory, and no position downgrade is required.
- 4.1.5.5 The highest marks will be given if the central point of a competition flight is above the secondary axis and if each figure is optimally positioned laterally and at an appropriate distance from the judges within the performance zone. The judge's positioning marks will take into account any imbalance between non-optimally positioned figures to reflect the left-to-right symmetry of the sequence flown by the competitor.
- 4.1.5.6 For each figure the judge shall add a reference in the “Pos” column describing the position of the figure if this is observed to have been non-optimal. The shape and size of the figure and the location of any manoeuvres within it shall be compared to the optimum position of the whole figure when considered within the design of the sequence. Where the position of a figure is somewhat or considerably non-optimal because it is too much to the left or the right or too near or too far away, the following annotations (or their local / national equivalent) shall be used:

| Figure Position                | The ‘Pos’ annotation |                          |
|--------------------------------|----------------------|--------------------------|
|                                | Somewhat non-optimal | Considerably non-optimal |
| Left of the optimum position:  | “L”                  | “LL”                     |
| Right of the optimum position: | “R”                  | “RR”                     |
| Too near to the judge:         | “N”                  | “NN”                     |
| Too far from the judge:        | “F”                  | “FF”                     |

- 4.1.5.7 At the end of the sequence the annotations in the “Pos” column shall be used by each judge to determine a sequence positioning downgrade based primarily on these recorded observations. Each single letter is taken as equivalent to a half mark and each double letter equivalent to a full mark downgrade. For example, the figure “Pos” annotations L, R, N, FF, LL and R would combine as a downgrade of 4.0 marks. The Judge is entitled to revise his final positioning mark up or down by a maximum of 1 point if he considers there were other relevant factors which should be taken into account to reduce or increase the downgrade.



#### **4.1.6. Calculation of Scores**

- 4.1.6.1 The marks given by a Judge are processed by the Fair Play System (FPS), with the final scores being determined for a programme as a whole.

#### **4.2. Boundary Judging**

- 4.2.1.1 The recording of infringements of the performance zone defined in 3.4.1.5 may be carried out only with a CIVA-approved electronic tracking system.
- 4.2.1.2 If an electronic tracking system is used, the position of the aircraft will be tracked by the instrument and performance zone boundary infringements (including the 50 m buffer zone) according to 3.4.1.5 recorded. A member of the International Jury or a neutral person assigned by the I.J. must be present at the recording station to monitor the operation of the system.

#### **4.3. Electronic Height Measuring**

- 4.3.1.1 Electronic height measuring devices (HMDs) may be used. The electronic height measuring system used, as well as the rules to operate it, must be approved by CIVA.
- 4.3.1.2 Whenever an HMD is used, it will be the primary reference to verify compliance with height limits and for decisions on penalties or disqualifications due to height infringements.
- 4.3.1.3 The final decision whether a penalty should be given or not on the basis of outputs from the HMD rests with the Chief Judge. For detailed information on the various HMD systems and their operation see Appendix 0.
- 4.3.1.4 Persons operating and maintaining the HMD system are international officials. Their status is comparable to the Technical Commission or International Judges. They are assigned and responsible to the Chief Judge and must not be associated with one of the competing teams. Throughout the competition all the HMD hardware must remain in the custody of the persons designated for this task and must not be accessible to competitors or team officials.

#### **4.4. Penalties Deductible from Total (Averaged) Scores**

##### **4.4.1. Infringements of Height Limits**

- 4.4.1.1 A competitor flying a figure or part of a figure lower than 200 m (over datum) will receive 70 penalty points for this figure. A competitor flying their programme lower than 100 m (over datum) will be disqualified for this flight.
- a) When an HMD is used, a penalty of 70 points is given if the first figure is started above 1200 m or this limit is exceeded in the course of the first figure. If the upper limit is exceeded during a subsequent figure, there will be no penalty. The start of a figure occurs when the aircraft departs from level flight for the first time or when a roll is started on a horizontal line.
- b) When an HMD is used, the Judges will mark all the figures regardless of the altitude and also note down any height infringements they observe. The excursions below 200 m will be recorded at the Chief Judge's position and penalty points will be assessed accordingly. 70 penalty points will be given for every figure during or before which the 200 m signal is received and confirmed to be correct.
- In case of doubt, the official video should be checked for audible outputs from the HMD equipment in relation to aircraft flight path and/or attitude at the time of the HMD signal in order to determine whether the signal was received before or after the completion of a figure and thus whether a penalty should be given or not.



- c) The end of a figure occurs as soon as the aircraft exits the curved portion of the manoeuvre and enters horizontal or gliding flight, or as soon as the aircraft flies through the horizontal line between two figures. In rolls, the end of the rotation along the longitudinal axis is taken to be the end of the figure.
- d) In any case, the final decision whether a penalty should be applied or not rests with the Chief Judge.

4.4.1.2 In the case where the lower height boundary is supervised by using an aiming device, the respective boundary judge will transmit a height infringement to the Chief Judge.

4.4.1.3 In the case where the Judges assess the lower boundary, each Judge will note in writing a height infringement on his score sheet, independent of the other Judges; however, they continue to evaluate the figure being flown.

4.4.1.4 When infringements of the lower height limits are estimated by the judges, they will be penalised only if a simple majority has recognised the violation and duly recorded this on their marking sheets. In case the required simple majority could not rise from a vote within the Board of Judges, the Chief Judge shall have a casting vote.

#### **4.4.2. Infringements of the Performance Zone**

4.4.2.1 Excursions outside the performance zone (plus 50 m tolerance) will be registered by the electronic tracking system. The time flown outside the performance zone is penalised by 2 points per second.

4.4.2.2 All figures of a programme even when they are flown outside the boundaries of the performance zone, are marked; wide excursions however may influence the position mark.

4.4.2.3 A figure is flown too far to be marked correctly; the deduction is 2,0 points.

#### **4.4.3. Insertions**

4.4.3.1 Each insertion will be penalised by 70 points. An insertion is any manoeuvre involving a direction change of more than 90 degrees that is not designated in the flight programme; except manoeuvres covered by 4.4.3.2. These can be:

- a) A manoeuvre to return to the performance zone.
- b) Any manoeuvre which is not part of the current sequence (e.g. full circles).

4.4.3.2 If a pilot is compelled to change their direction after a mistake or after an abandoned figure in order to resume the predetermined direction and has already received a Hard Zero mark for that figure, no penalty points for an insertion will be subtracted. This correction of direction or orientation must not be more than a heading change of 180 degrees or attitude change of more than one half roll or half loop.

4.4.3.3 In glider aerobatics there are NO interruptions or breaks with wing rocking before and after. Wing rocking indicates the conclusion of the programme.

4.4.3.4 Interrupting a sequence in order to gain altitude by thermalling will lead to disqualification for that flight programme.

#### **4.4.4. Violation of Training**

4.4.4.1 Training for Unknown Programmes will lead to disqualification from the entire contest

4.4.4.2 The pilot will be assigned 200 penalty points for each figure flown which is not part of the current programme.



**4.4.5. Failure to Appear**

- a) In the case of the failure of the participant to appear at the designated take-off time, the pilot can be changed to the end of the current programme in the Free Known Programme, however they will receive a warning and 300 penalty points for that flight. If the same pilot fails to appear again, they will not be allowed to start in that programme.
- b) In the case of the failure to appear at the designated take-off time for an Unknown Compulsory Programme, the competitor will not be allowed to participate in that flight programme. Exceptions from this rule can only be made on a case-by-case basis by the International Jury.
- c) In urgent cases the participant may report late to the starter, but the variation from the stated rules can only be authorized by the International Jury.

**4.4.6. Improper Wing-Dipping at the Beginning or End of a Programme**

- 4.4.6.1 35 penalty points will be awarded for failure to do wing dips correctly at either the beginning or ending of a programme, or doing it so little that it is not apparent to the judges (see 3.8.1.3).

**4.4.7. Violation of Flight Regulations and Dangerous Flying**

- 4.4.7.1 Competitors found guilty of violating flight regulations and/or causing a dangerous situation will, on the recommendation of the International Jury, be disqualified by the Contest Director. The Chief Judge may, with the agreement of two-thirds of the Board of Judges, exclude a pilot who is not flying safely or whose flying could cause an unsafe situation. This would apply from take-off to touchdown. (see 1.2.8.5)

**4.5. Deductions applicable to Figures**

It is assumed by a Judge that a contestant is going to fly a perfect figure, therefore he/she starts with the mark of 10 and proceeds to downgrade this mark by fixed values as prescribed herein and by further values in conformity with the Judging Criteria in Appendix B.

**4.5.1. Downgrades**

- 4.5.1.1 For deviations from the correct geometry (plane of flight, direction of flight, angle of bank) and for deviations from the proper flight path or the proper attitude (as appropriate), the mark will be reduced by 1 point per 5 degrees of deviation.
- 4.5.1.2 The absence of a distinct horizontal start and/or finish to a figure will reduce the mark by 1 point in each case for each figure affected (B.8.1.4).
- 4.5.1.3 Horizontal lines will be judged on flight path, not the attitude of the glider (see B.3.1 and B.8.1.2). Horizontal lines in glider aerobatics may be inclined between zero (0) and ten (10) degrees below the horizon.
- 4.5.1.4 The reference for vertical and 45-degree lines is the angle of the zero-lift axis (see B.3.2.1) relative to the true horizon. On vertical and 45-degree lines, the flight path is subject to wind influence and must be ignored when judging these lines.
- 4.5.1.5 If while in the pre-stated flight plane (vertical, horizontal, 45-degree inclination) a competitor allows his glider to bank around the longitudinal axis, the mark will be reduced by 1 point for every 5 degrees of difference between the actual and the prescribed plane of flight.
- 4.5.1.6 If within a figure two or more lines have to be of the same length, the basis for judging is the first line flown. Any observed variation must be penalised by reducing the marks in accordance with paragraphs B.8.1.11 and B.8.1.12.



- 4.5.1.7 Over-rotating a roll and rolling the wings back again must be penalised by 1 point per 5 degrees of over-rotation, even if the correct geometry is resumed afterwards, no matter how quickly the correction is made. The same provisions apply when, at the end of a loop or part-loop, the aircraft is pitched beyond the desired line and then brought back again (see B.8.1.14).
- 4.5.1.8 Rolls flown in combination with a turn (Family 2) or loop (Families 7.4, 8.6 and 8.7) must be smoothly continuous, i.e. there must not be any change in the rate of roll from beginning to end. Specific downgrades for rolling turns are noted in paragraph B.9.3.6.
- 4.5.1.9 If the total of downgrades in this section leads to a value lower than the score of 0.5, a mark of 0.0 (numerical zero) will be awarded to the figure.
- 4.5.1.10 When awarding any kind of zero-mark (i.e. numerical 0.0 or hard zero) judges must state the reason why the figure was marked zero.

#### **4.5.2. Hard Zero**

- 4.5.2.1 A mark of "Hard Zero" (HZ) must be awarded if the judge considers that the figure is incorrectly flown in respect of a geometrical error, as listed below, that is clearly verifiable as a matter of fact. A mark of HZ will be awarded if:
- a) Any figure is flown which does not conform to the drawing held by the judges for marking purposes (Forms B/C or L/R). Note: When a figure is inserted to a sequence, Rule 4.4.3.1 applies.
  - b) When rolls are superimposed on a turn (rule 4.5.1.8), the roll is finished but 90° or more of the turn still remains to be flown.
  - c) Any deviation from the prescribed direction reaches 90 degrees.
  - d) Any other single deviation in geometry/flight path/attitude/rotation reaches 90 degrees.  

*After a directional deviation of 90 degrees or more on the Y-axis, although it is non-directional, the original direction must be re-established before the next figure is flown.*
  - e) The pre-stated figure or any part of it is omitted.
  - f) Any part of the figure was not visible as it was flown in or behind cloud. If the figure was visible to a majority of judges, then the Chief Judge should instruct unsighted judges to revise their mark from "HZ" to "A".
  - g) a flick roll never started proper auto-rotation.
  - h) a spin never started proper auto-rotation.
  - i) a rolling turn included a flick roll.
  - j) a visible line inserted between loop segments and rolls in families listed in B.9.8.1 is longer than 2R.
- 4.5.2.2 If figures subsequent to a Hard Zero mark are correct and are flown in the correct direction, they shall be marked in the normal way.
- 4.5.2.3 During a repetition flight (paragraph 3.11.1.8) the figures before the break must all be flown correctly. If a competitor omits or flies such a figure incorrectly, so as to gain an unfair advantage, the mark awarded for that figure during the first flight will be reduced to a Hard Zero.



### **4.5.3. Alignment on Hard Zeros**

4.5.3.1 The awarding of Confirmed Hard Zero marks is determined by the Chief Judge, if necessary, after a judging conference. When a Judge's vote is over-ruled, upward correction of a Hard Zero will be to a Fitted Value determined by the scoring software. When awarding a Hard Zero, judges are to write down the nature of the error and are not to give a 'reserve' mark. A Judge has the right to ask for a video review, if it is determined that his written score is incorrect and he is not in agreement with this ruling.

The recommended procedure for handling Hard Zeros and penalties on the judging line can be broken down as follows:

#### 4.5.3.2 Hard Zeros given by the Majority of Judges

- a) The score sheets go to the scoring office unchanged; the Chief Judge having checked the Confirmed Hard Zero (CHZ) box on the score sheet, unless a conference to confirm the facts is demanded by any judge(s). The computer system changes the minority scores to HZ and determines the judges' HZI points.

#### 4.5.3.3 Hard Zeros given by 50% or less of the Judges

- a) The Chief Judge first determines by means of conferencing whether the Hard Zero is correct or not. If correct, the Chief Judge will check the "CHZ" box on the score sheet, If not he will leave it blank. The judges must not change their score sheets as a result of the discussion. The score sheets will then go to the scoring office, and the computer system will then change the incorrect marks and determine judges' HZI points.

#### 4.5.3.4 Case of Hard Zeros referred to or determined by the International Jury:

- a) The Chief Judge may on occasions, where there is a mixture of scores and Hard Zeros for a figure, not be able to determine the validity of the Hard Zero score(s), due to uncertainty in the Regulations (e.g. paperwork errors). In such instances the Chief Judge shall tick the CHZ box and then refer the matter to the International Jury for clarification and a decision.
- b) If no consensus is reached during the judge's conference, the CJ can decide to check the "CHZ box".
- c) Where the International Jury determines the Hard Zero mark is correct, those judges who had given numerical marks will have their marks changed to Hard Zero by the President of the International Jury, without prejudice to their Ranking Index.
- d) Where the International Jury determines the Hard Zero mark is incorrect, the Hard Zero confirmation will be reversed and those judges who have given Hard Zeros will have their marks changed to an average by the President of the International Jury, without prejudice to their Ranking Index.

4.5.3.5 When a Judge's Hard Zero vote is over-ruled, upward correction of a Hard Zero will be to a Fitted Value determined by the scoring software.

### **4.5.4. Errors in Recording Hard Zeros**

4.5.4.1 The Chief Judge will examine the reasons given by the scoring judges for the award of Hard Zeros. If a scoring judge has made a mistake and quoted a reason not applicable to the recorded mark the Chief Judge will instruct the scoring Judge to change his mark. In this way true zeroes can all be brought to a common solution, providing correction to the judge and clarity for the pilot.



#### 4.5.4.2 Hard Zero Index (HZI)

The Hard Zero Index (HZI) will be calculated by the computer, based on the marks given by the judges and the status of the “CHZ box”.

#### 4.5.5. Mix of Zeros

The CIVA results calculation software will handle a mix of Hard Zeros or “A” marks. In order for this to function correctly, the Chief Judge, if necessary, after a conference as described in paragraph **Fehler! Verweisquelle konnte nicht gefunden werden.**, must fill the Confirmed Hard Zero (CHZ) field on the judging sheets if a Hard Zero was in fact flown. If review shows the figure to have been correct, the “CHZ” box must be left open.

4.5.5.1 If during this process the Chief Judge establishes that there is a mix of Hard and Numerical Zeros for the same error, i.e. it is only the extent of the error above 45-degrees that cannot be established, and these combined Zeros are in the majority for this error, the Chief Judge shall instruct those judges with the Numerical Zeros to change their score sheets to Hard Zeros and sign the sheets accordingly. The Chief Judge will then fill the CHZ field. Consequently, no judge will in this instance have a point added to his Hard Zero Anomaly count.

4.5.5.2 Should a judge consider a figure started behind the judges, the judge shall mark the figure regardless, but add the comment, “Behind” in the Remarks section of Forms A or L/R. At the end of each flight, the Chief Judge shall determine by a simple majority (with the Chief Judge casting a vote as required), if the figure in question was started behind the judges. If the majority holds that the figure was started behind the judges, the Chief Judge shall change all judges’ marks to ‘HZ’. If the figure is deemed by the majority to have been flown in front of the Judges, the original marks shall be handled as with any other figure.

### 4.6. Judging Administration

#### 4.6.1. Paperwork

4.6.1.1 All paperwork supplied to the Board of Judges except that specifically prepared for use by the Chief Judge and the video operator should have all references to the pilots’ identity removed.

#### 4.6.2. Collection of Marking Sheets

4.6.2.1 Immediately after a competitor has completed a competition flight and the judges have finished marking, the marking sheets will be collected for perusal at the Chief Judge’s workstation. Once any required actions are taken (conference, penalties added, zeros checked etc.) the marking sheets will be forwarded to the scoring office for entry into the scoring system. The individual judges themselves must sign off any changes to their marking sheets.

4.6.2.2 Once the marking sheets have left the Chief Judge’s workstation, they come under the supervision and jurisdiction of the International Jury.

#### 4.6.3. Publication of Results

4.6.3.1 It shall be a duty of the organiser to arrange for the publication of the competition results. The marking sheets must be made available to the competitors, Chief Delegates, Team Managers, and Contest Officials for information and/or checking before the start of the subsequent programme.

4.6.3.2 The raw scores of each pilot, by judge, will be published after that pilot’s flight without classification or normalisation of the scores. Penalty points will also be listed. The final scores and classification of the performance of the pilots is to be made after the completion of each programme. These will be available not later than the beginning of the flight programme subsequent to the next. Example: Programme 1 final scores must be available before the start of Programme 3.



4.6.3.3 A copy of the files generated by the Computer Scoring System must be available to any official or Team Manager upon request, once the contest is concluded. A complete copy of all the files must be sent to the Bureau of CIVA after the contest.

**4.6.4. Public Announcements**

4.6.4.1 Prior to the take-off for and during the performance of a programme, details concerning the competitor concerned may be published by any means (radio commentary, etc.).

**4.6.5. Official Video Recording**

4.6.5.1 An official video recording shall be made from the Judges' position of every individual competition flight in a World Championship. The official recording shall be available to the International Jury to assist their decision on any protests. The recording shall not be available to competitors or Team Officials at a World Championship, except in the clarification of a protest in conjunction with the International Jury and with their agreement. The official recording shall also be available to the Chief Judge and the Board of Judges to assist their discussion on matters of fact.

4.6.5.2 These video-recordings will be given to the Chief Judge after each programme and will be kept in his personal possession until the end of the contest and will only be made available to the International Jury.

4.6.5.3 After the completion of the championships, the recording may be released by the organisers for use in training.

**4.6.6. Judges' Performance Evaluation**

4.6.6.1 Judges evaluation by flight programme will be conducted by the International Jury using the software programme approved by CIVA. The Chief Judge will receive in print format a complete analysis of all Judges from the International Jury after each programme is completed.

4.6.6.2 Individual judging analysis for each judge will be posted online following the conclusion of each programme. The Chief Judge should make himself available for discussion with individual judges to facilitate their review of this material.

4.6.6.3 The complete judging analysis of the whole contest including the Chief Judge's complete analysis of all judges will be made available after the competition has been completed.

**4.6.7. Reprimand and Disqualification of Judges**

4.6.7.1 The reprimands and/or the disqualification of judges by the International Jury shall be administered in compliance with the appropriate Sporting Code.

4.6.7.2 In case of a disqualification of a judge, the marking which was the reason for the disqualification will not be counted for the programme in question. CIVA will decide upon the further use of the disqualified judge on the recommendation of the International Jury.

4.6.7.3 On the basis of judging data, which have to be available promptly, it is the duty of the International Jury to monitor the performance of the judges.

**4.6.8. Substitute Judge**

4.6.8.1 If a substitute International Judge is appointed under above, they shall only take their place on the Board of Judges at the start of the subsequent programme, and the marks of the departed judge for the programme they did not complete will be ignored.



**5. AWARDS**

**5.1. Titles definition**

- 5.1.1.1 Overall Champion: The competitor who gains the highest total number of combined points in all the Programmes which have been completed.
- 5.1.1.2 Champion Team: The team with the highest total number of combined points in the Programmes flown by all competitors, taking into account the three highest individual scores in that team (or two if rule 1.2.6.1.b) is in force), provided that there are at least 3 teams with at least 2 competitors each.
- 5.1.1.3 Overall Junior Winner: The Junior competitor who gains the highest total number of combined points in Programmes 1 to 4 (provided at least Programmes 1 and 2 are completed), regardless of gender. Junior competitors are defined as competitors reaching 26 years of age no earlier than 1 January of the year of the championship, according to their official ID or passport.
- 5.1.1.4 Winners in the Individual Programmes.
- a) Winner in the Free Known Programme: The competitor who gains the highest number of points in Programme 1.
  - b) Winner in the Free Unknown Programme: The competitor who gains the highest number of points in Programme 3.
  - c) Winner in the Combined Unknown Compulsory Programmes: The competitor who gains the highest cumulation of points from Programmes 2, 4, 5 and 6.

**5.2. Generalities**

- 5.2.1.1 The Organiser is recommended to give awards at World and Continental Championships to the Chief Judge, the Panel of Judges and the Scoring Office.



**5.3. Unlimited Contests**

**5.3.1. World Championships**

5.3.1.1 Titles, Medals and Trophies will be awarded according to the following tables.

| Titles                           | FAI Medals      | Trophies                                      | FAI Diplomas |
|----------------------------------|-----------------|---|--------------|
| World Unlimited Champion         | Gold<br>64 mm   | Roland Küng<br>World Glider Aerobatics Trophy | yes (b)      |
| Second place                     | Silver<br>64 mm |   | yes          |
| Third place                      | Bronze<br>64 mm |   | yes          |
| World Unlimited Team<br>Champion | Gold (4 a)      |   | yes (4)      |
| Second place                     | Silver (4 a)    |   | yes (4)      |
| Third place                      | Bronze (4 a)    |   | yes (4)      |

- a) Team medals: 1 medal 64 mm for the Team Manager; 3 medals 50 mm for the highest scoring pilots.
- b) FAI Diplomas are awarded to the ten highest scoring pilots overall.
- c) Fourth through sixth places Teams are awarded diplomas of the FAI (4 each).

| Titles                               | CIVA Medals | CIVA Medals | CIVA Medals | FAI Diplomas |
|--------------------------------------|-------------|-------------|-------------|--------------|
| Winners for the Free Known           | Gold        | Silver      | Bronze      | yes          |
| Winners for the Free Unknown         | Gold        | Silver      | Bronze      | yes          |
| Winners for the Combined<br>Unknowns | Gold        | Silver      | Bronze      | yes          |
| Junior Winners                       | Gold        | Silver      | Bronze      | yes          |



**5.4. Advanced Contests**

**5.4.1. World Championships**

5.4.1.1 Titles, Medals and Trophies will be awarded according to the following tables.

| Titles                          | FAI Medals      | Trophies  | FAI Diplomas |
|---------------------------------|-----------------|---|--------------|
| World Advanced Champion         | Gold<br>64 mm   | Roland K ung World Advanced<br>Glider Aerobatics Trophy | yes (b)      |
| Second place                    | Silver<br>64 mm |   | yes          |
| Third place                     | Bronze<br>64 mm |   | yes          |
| World Advanced Team<br>Champion | Gold (4 a)      |   | yes (4)      |
| Second place                    | Silver (4 a)    |   | yes (4)      |
| Third place                     | Bronze (4 a)    |   | yes (4)      |

- a) Team medals: 1 medal 64 mm for the Team Manager; 3 medals 50 mm for the highest scoring pilots.
- b) FAI Diplomas are awarded to the ten highest scoring pilots overall.
- c) Fourth through sixth places Teams are awarded diplomas of the FAI (4 each).

| Titles                               | CIVA Medals | CIVA Medals | CIVA Medals | FAI Diplomas |
|--------------------------------------|-------------|-------------|-------------|--------------|
| Winners for the Free Known           | Gold        | Silver      | Bronze      | yes          |
| Winners for the Free Unknown         | Gold        | Silver      | Bronze      | yes          |
| Winners for the Combined<br>Unknowns | Gold        | Silver      | Bronze      | yes          |
| Junior Winners                       | Gold        | Silver      | Bronze      | yes          |



# **APPENDICES**



**A. APPENDIX A: LIST OF FIGURES FOR PROGRAMMES 2 THROUGH 6**

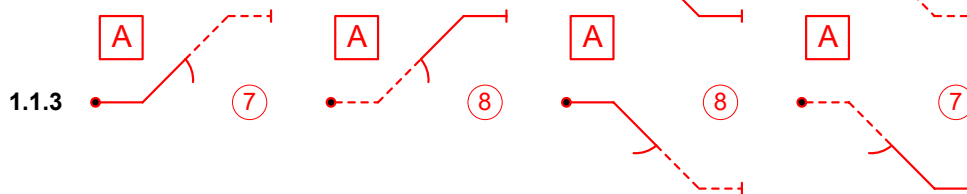
**A.1. Colour Coding**

A.1.1.1 Only figures or elements shown in red and annotated with [A] are allowed in Advanced Glider contests.

**A.2. Roll and Spin Combinations**

A.2.1.1 Opposite aileron or hesitation rolls are allowed on horizontal lines only.

**A.3. Family 1.1, Single Lines**



1

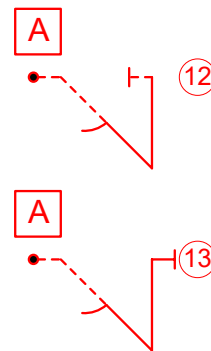
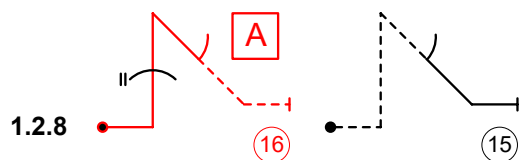
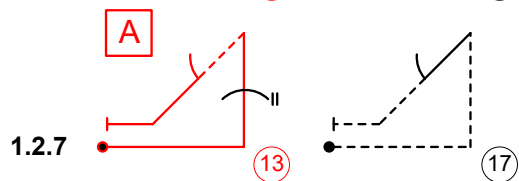
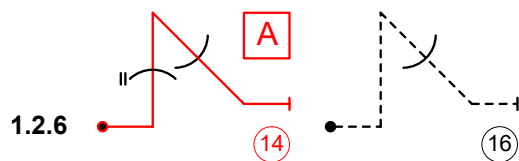
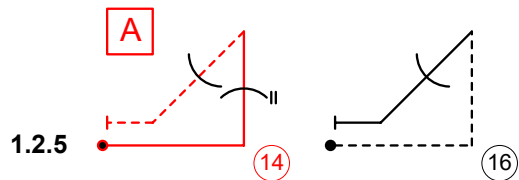
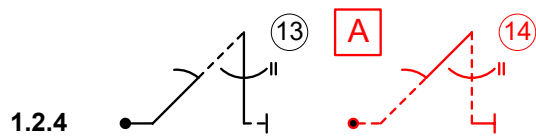
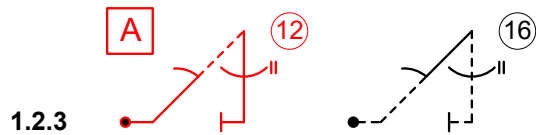
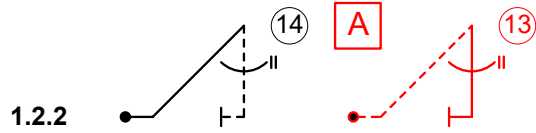
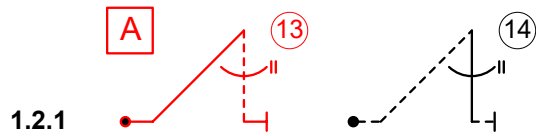
2

3

4

A.3.1.1 1.1.6.4 and 1.1.7.3 not more than ¼ slow roll before negative exit for SZD-59 Acro and MDM 1 Fox.

A.4. Family 1.2, Two Lines



1

2

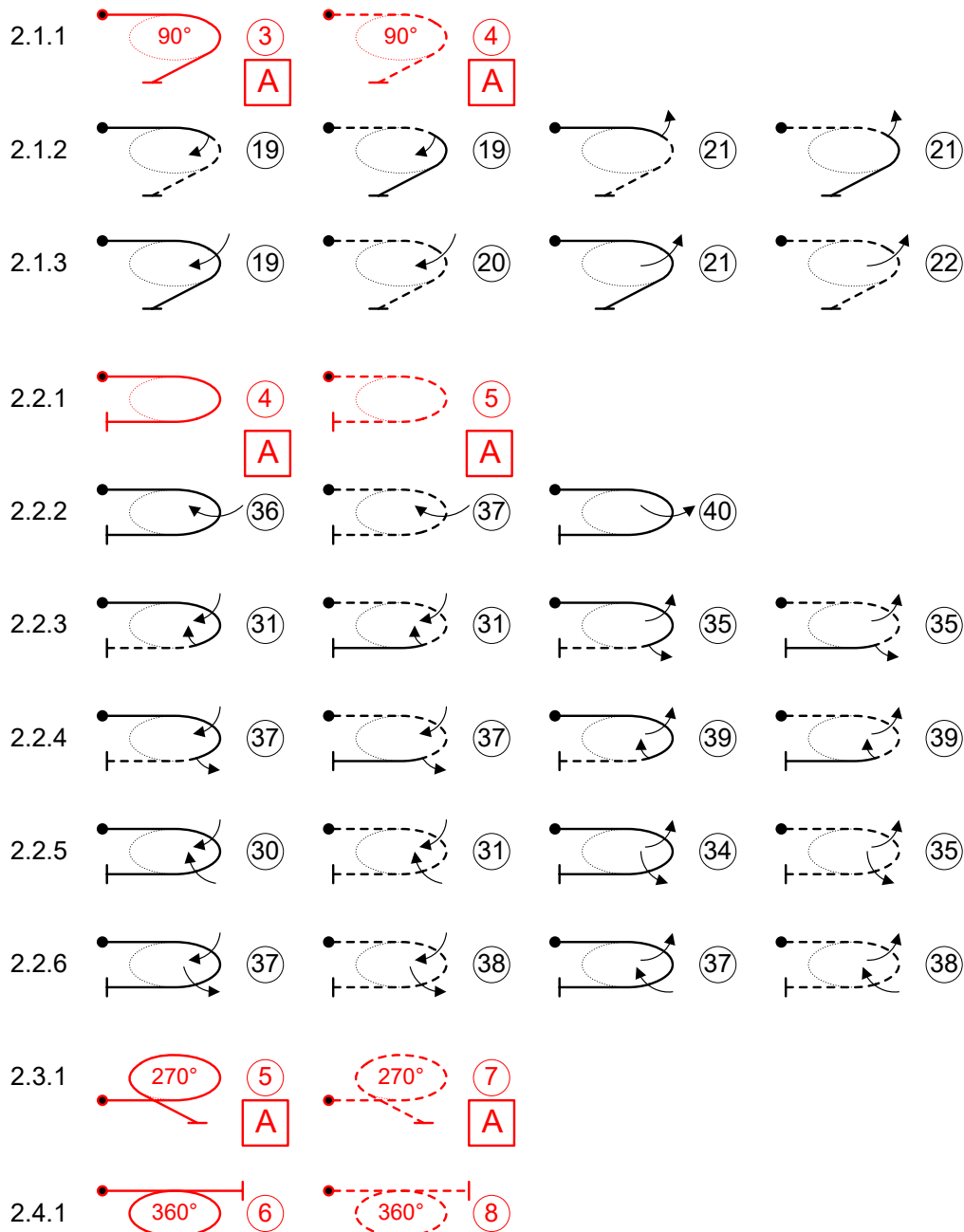
4

A.4.1.1 No vertical rolls in figures of column 2 of lines 1.2.5 to 1.2.8.

A.4.1.2 For SZD-59 and MDM 1 Fox not more than ¼ slow roll before negative exit on 1.2.1.2, 1.2.2.1, 1.2.3.2, 1.2.4.1.

A.4.1.3 For SZD-59 and MDM 1 Fox sum of rolling angle for slow rolls on negative 45° downward lines not more than 180° on 1.2.5.1 and 1.2.6.2.

A.5. Family 2, Turns and Rolling Turns



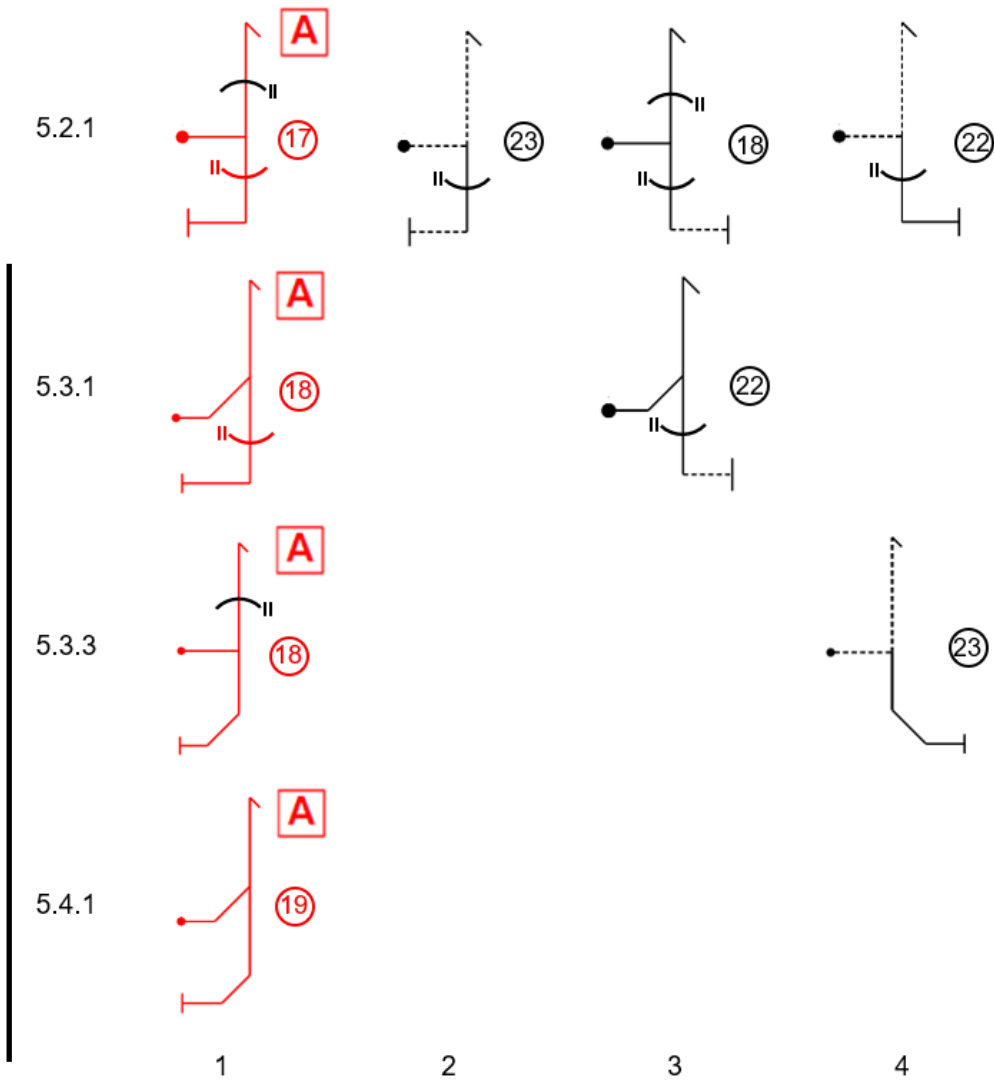
1

2

3

4

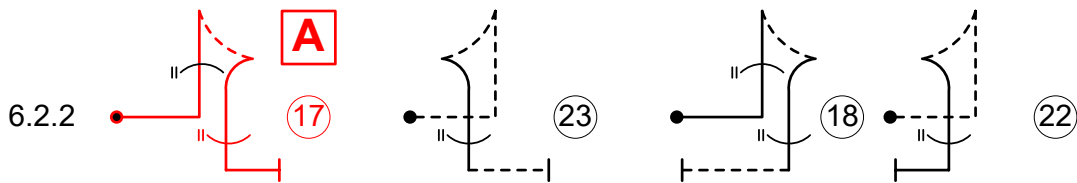
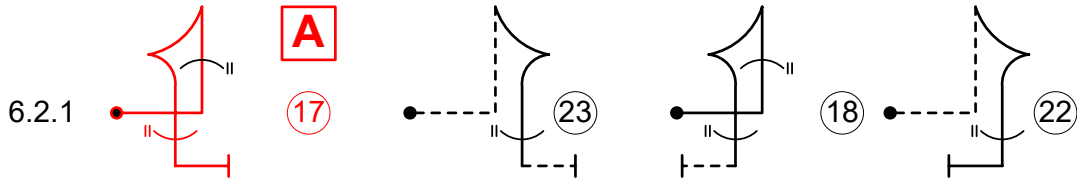
A.6. Family 5, Stall Turns



A.6.1.1 Rolling elements may only be added where indicated.

A.6.1.2 For SZD-59 Acro and MDM 1 Fox not more than ¼ slow roll before negative exit on 5.2.1.2 and 5.2.1.3.

A.7. Family 6, Tail Slides



1

2

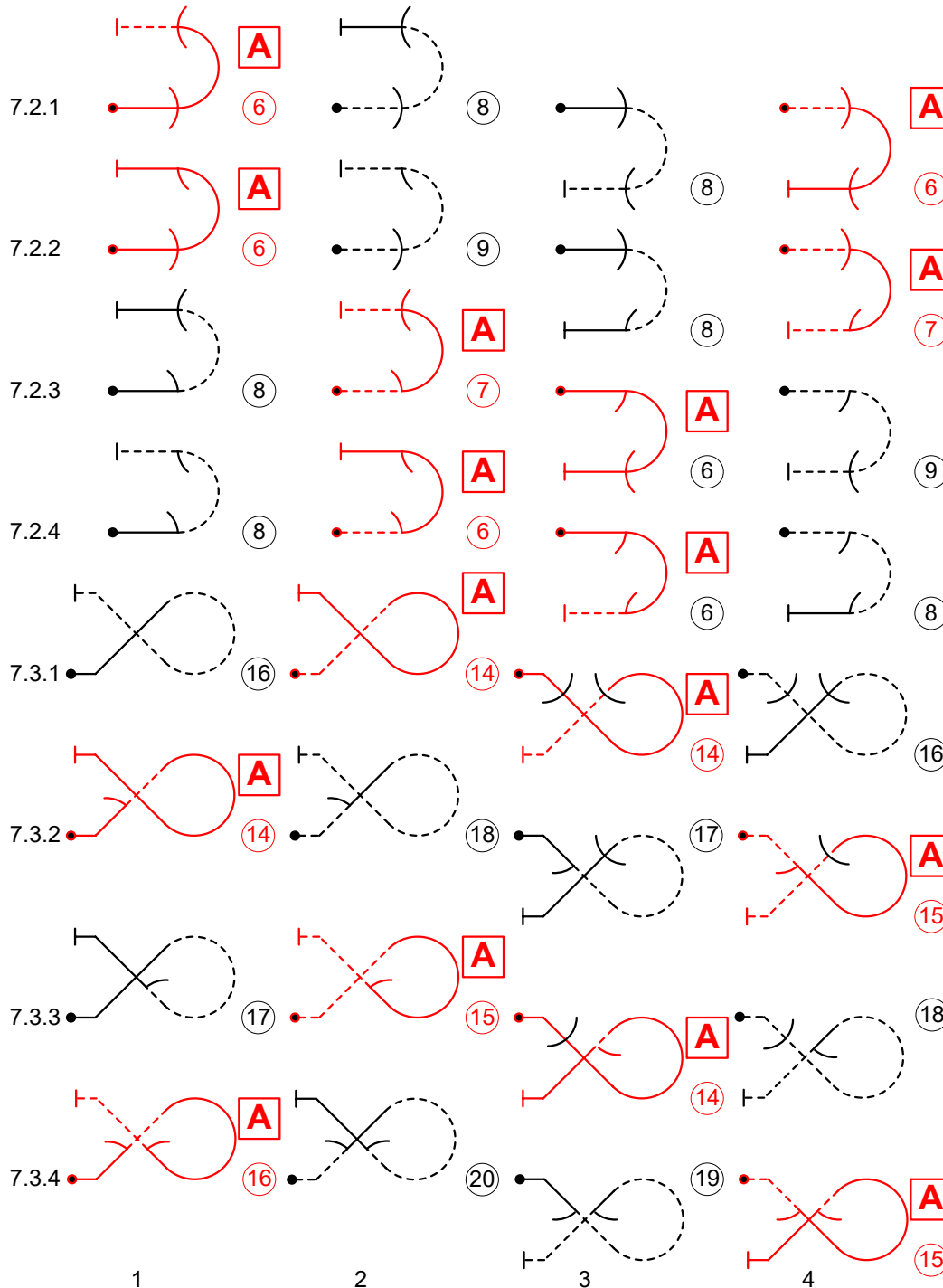
3

4

A.6.1.3 Rolling elements may only be added where indicated.

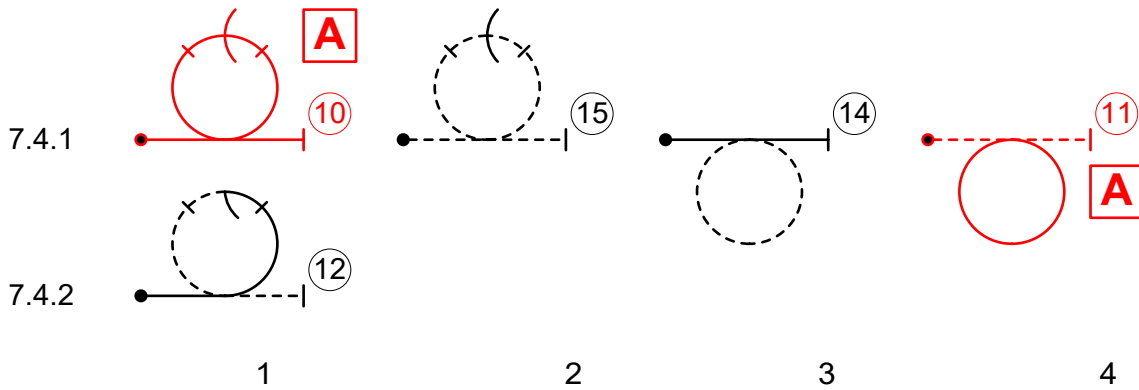
A.6.1.4 For SZD-59 Acro and MDM 1 Fox not more than ¼ slow roll before negative exit on 6.2.1.2, 6.2.1.3, 6.2.2.2, 6.2.2.3.

**A.8. Families 7.2, Half Loops and 7.3, Three-Quarter Loops**



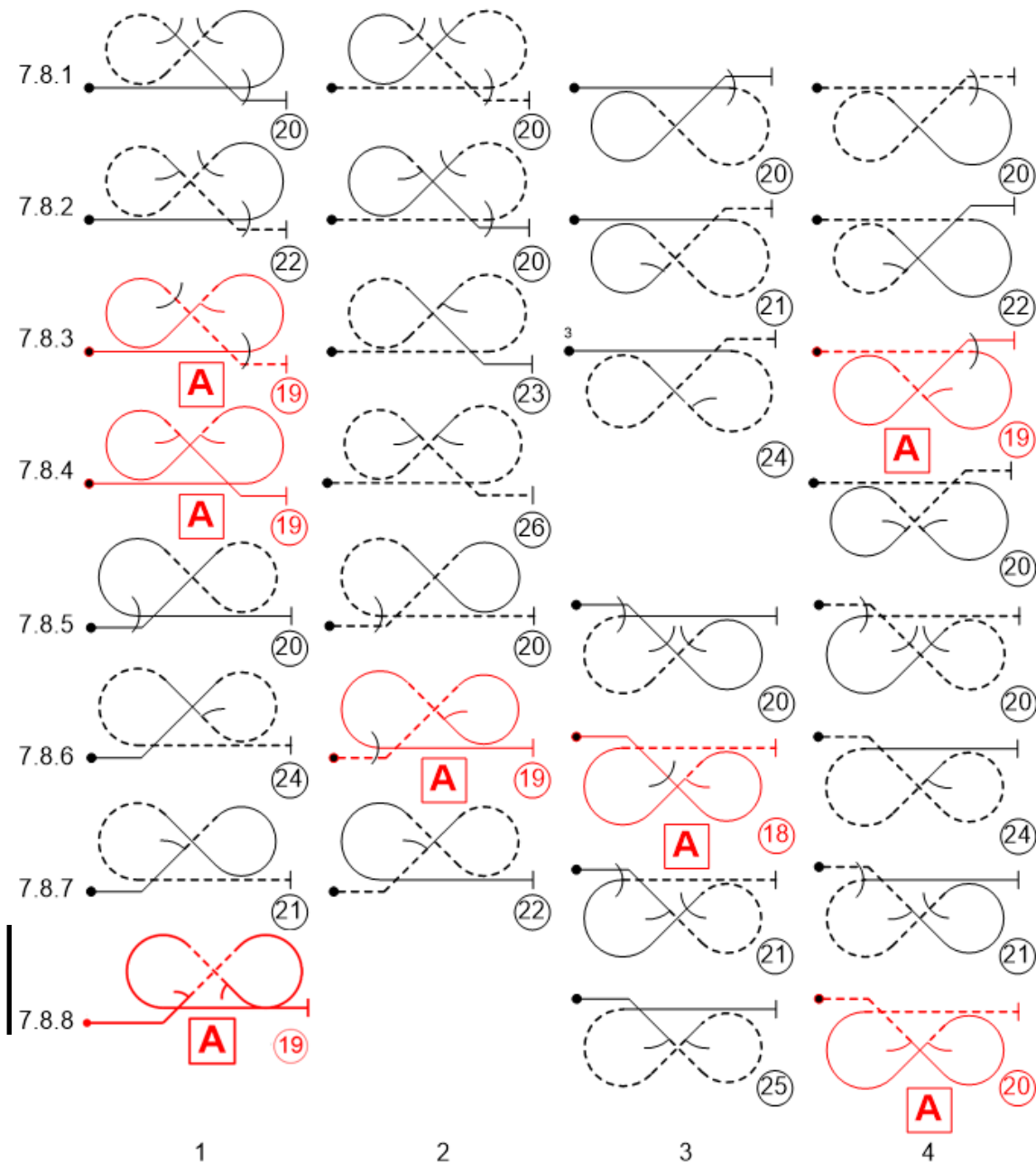
- A.8.1.1 No flick rolls on the horizontal entry lines of figures in columns 1 and 2, nor on the horizontal exit lines of figures in columns 3 and 4 of 7.2.1 to 7.2.4.
- A.8.1.2 No negative half flick rolls on 7.2.2.2 or 7.2.4.1.  
No positive half flick rolls on 7.2.2.1 or 7.2.4.2.
- A.8.1.3 Sum of rolling angle on negative 45° downward lines not more than 180° for SZD-59 Acro in columns 3 and 4 of 7.3.1 to 7.3.4

A.9. Family 7.4, Full Loops



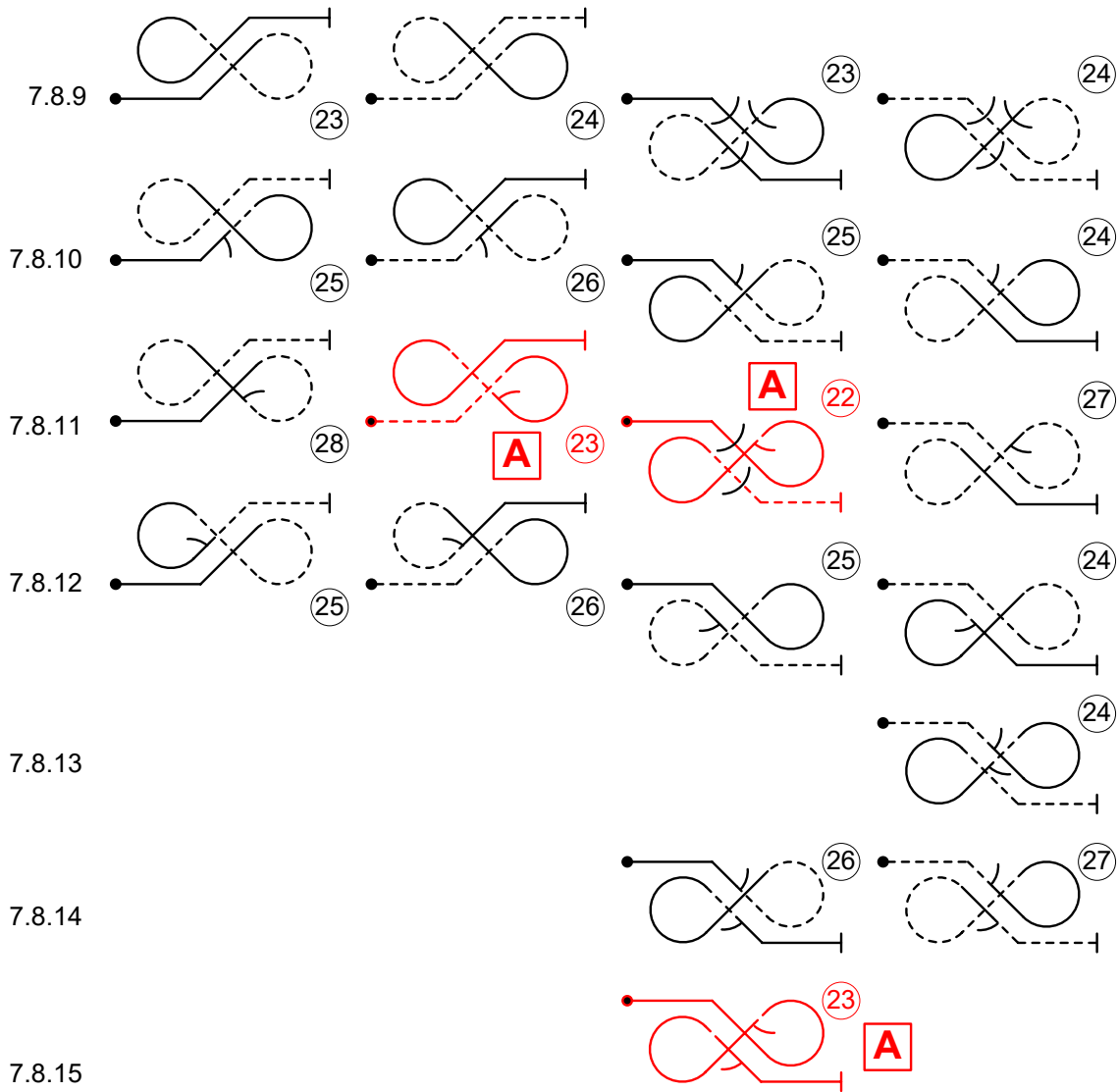
- A.9.1.1 No rolls on figures 7.4.1.3 and 7.4.1.4.
- A.9.1.2 No hesitation rolls in the top of figure 7.4.1.2.
- A.9.1.3 No more than one full roll on top of 7.4.1.1 and 7.4.1.2.
- A.9.1.4 No flick rolls for SZD-59 Acro on top of figure 7.4.1.2.

A.10. Family 7.8.1 to 7.8.8, Horizontal Eights



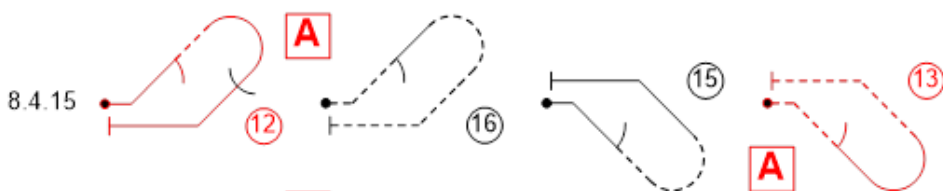
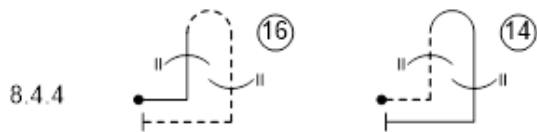
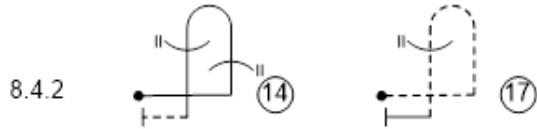
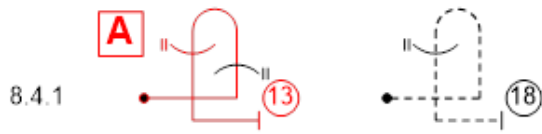
- A.10.1.1 No flick rolls on the horizontal entry lines of figures in columns 1 and 2 of 7.8.1 to 7.8.4.
- A.10.1.2 No flick rolls on the horizontal exit lines of figures in columns 1 and 2 of 7.8.5 to 7.8.8.
- A.10.1.3 Sum of rolling angle on negative 45° downward lines not more than 180° for SZD-59 Acro.

A.11. Family 7.8.9 to 7.8.15, Horizontal Super-Eights



A.11.1.1 Sum of rolling angle on negative 45° downward lines not more than 180° for SZD-59 Acro.

A.12. Family 8.4, Humpties



1

2

3

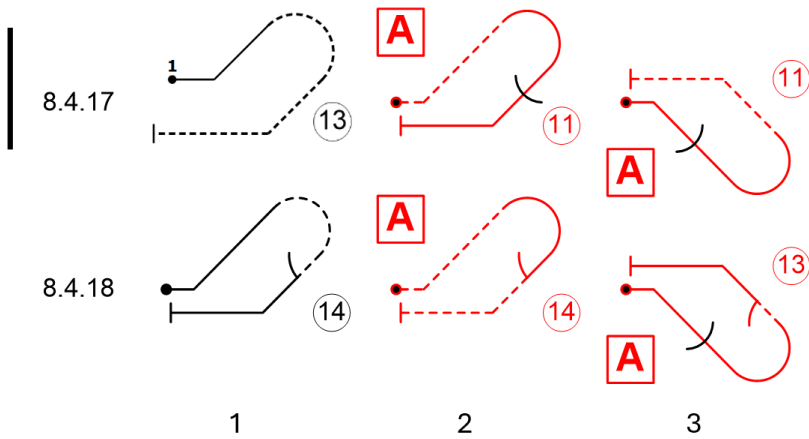
4

A.12.1.1 No rolls on the vertical uplines of 8.4.1.2 and 8.4.2.2.

A.12.1.2 No ½ slow rolls before negative exit for SZD-59 Acro and MDM 1 Fox on 8.4.1.2, 8.4.2.1, 8.4.3.2, 8.4.4.1.

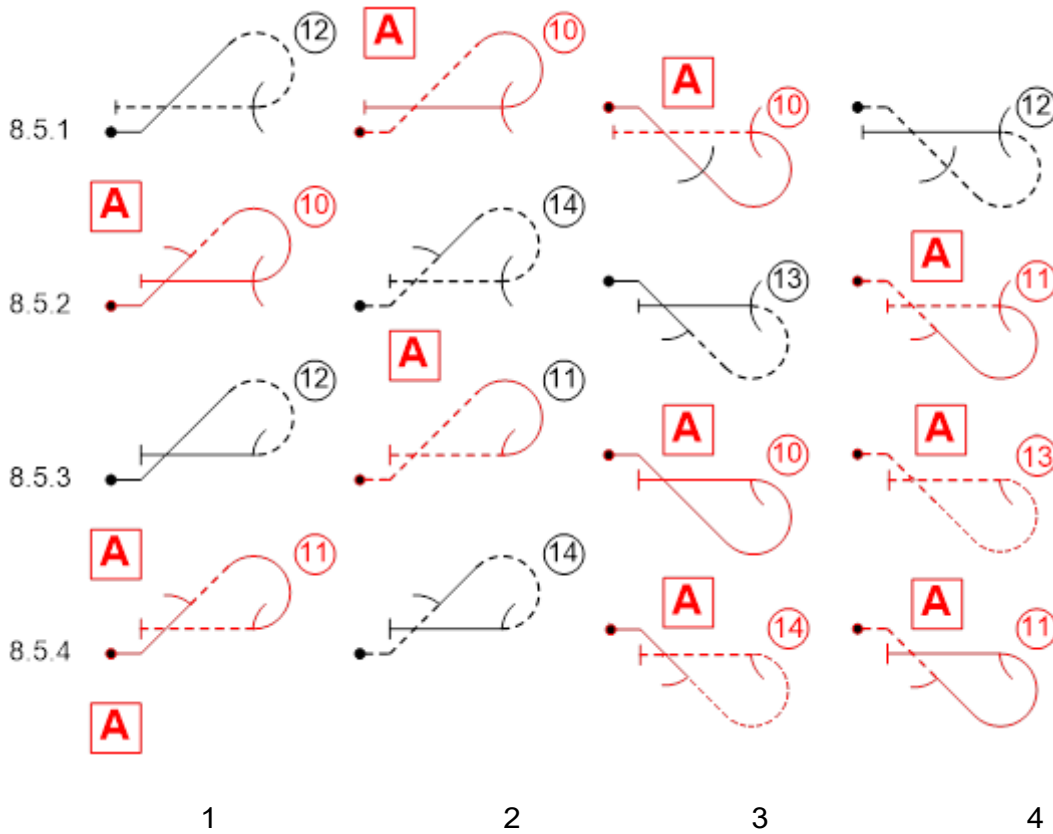
A.12.1.3 No full slow rolls for SZD-59 Acro and MDM 1 Fox on 8.4.15.1 and 8.4.15.2.

A.12.1.4 No full slow rolls for SZD-59 Acro on 8.4.13.1.



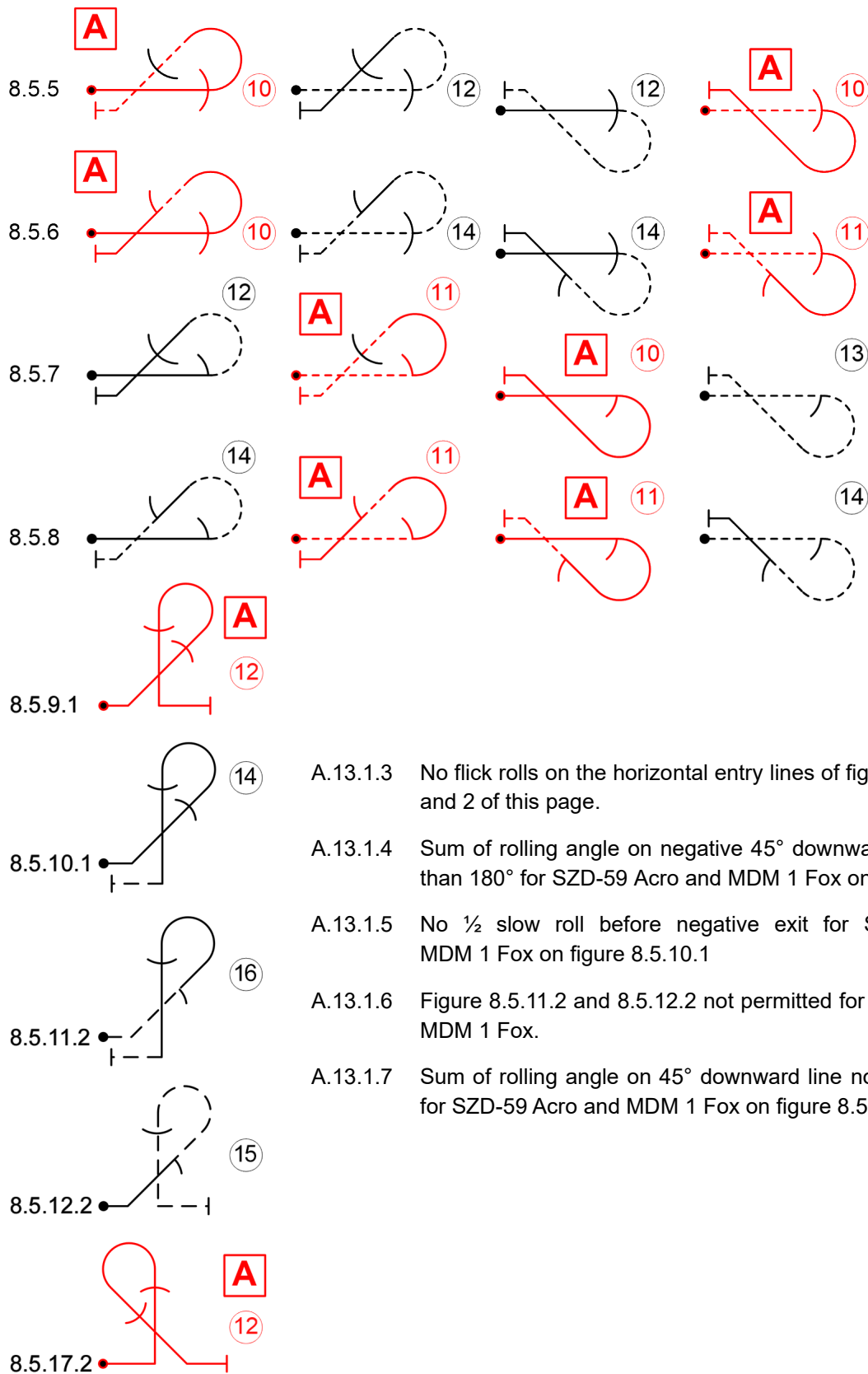
- A.12.1.5 No flick rolls on the down lines of figures 8.4.15.2, 8.4.16.2, 8.4.17.1 and 8.4.18.1.
- A.12.1.6 No full slow rolls for SZD-59 Acro and MDM 1 Fox on 8.4.17.1 and 8.4.17.2.

A.13. Family 8.5, Half Cubans



A.13.1.1 No flick rolls on the horizontal exit lines of figures in columns 1 and 2 on this page.

A.13.1.2 Sum of rolling angle on negative 45° downward lines not more than 180° for SZD-59 Acro.



A.13.1.3 No flick rolls on the horizontal entry lines of figures in columns 1 and 2 of this page.

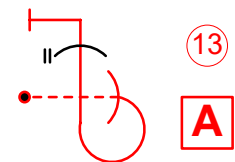
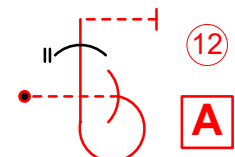
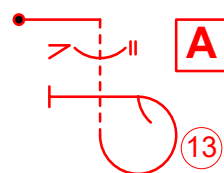
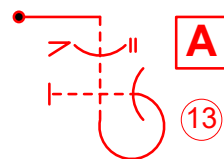
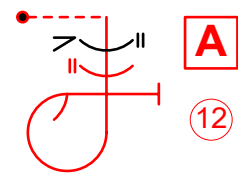
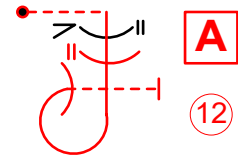
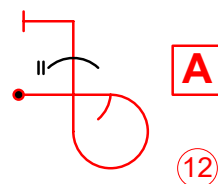
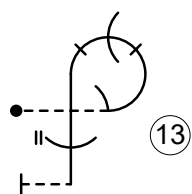
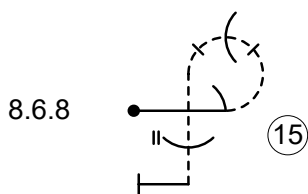
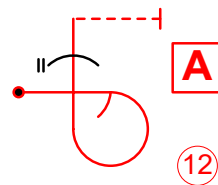
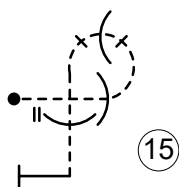
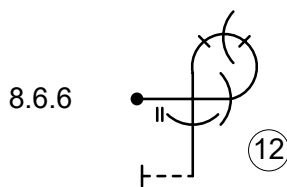
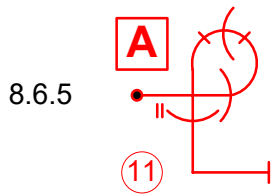
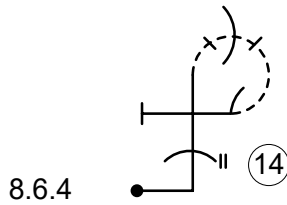
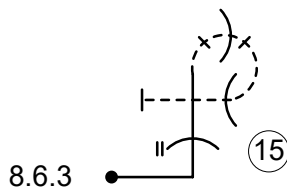
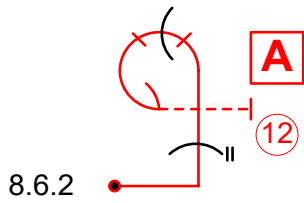
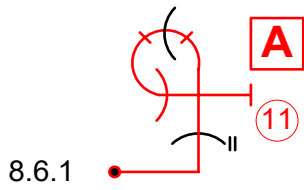
A.13.1.4 Sum of rolling angle on negative 45° downward lines not more than 180° for SZD-59 Acro and MDM 1 Fox on figure 8.5.5.1.

A.13.1.5 No ½ slow roll before negative exit for SZD-59 Acro and MDM 1 Fox on figure 8.5.10.1

A.13.1.6 Figure 8.5.11.2 and 8.5.12.2 not permitted for SZD-59 Acro and MDM 1 Fox.

A.13.1.7 Sum of rolling angle on 45° downward line not more than 180° for SZD-59 Acro and MDM 1 Fox on figure 8.5.17.1

A.14. Family 8.6, P-Loops



1

2

3

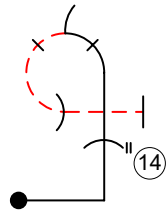
4



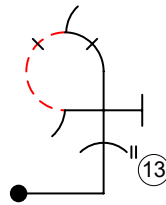
- 1.14.1.1 No more than one full roll on top of figures in columns 1 and 2 of 8.6.1 to 8.6.8.
- 1.14.1.2 No rolls on top of figures in column 1 of 8.6.1 to 8.6.4 after a roll on the up line.
- 1.14.1.3 No hesitation rolls on top of figures 8.6.3.1, 8.6.4.1, 8.6.6.2 and 8.6.8.1.
- 1.14.1.4 No flick rolls on horizontal entry and exit lines of figures in columns 1 and 2.
- 1.14.1.5 No flick rolls on vertical down lines of figures in columns 1 and 2 of 8.6.5 to 8.6.8 after a hesitation roll in the loop.
- 1.14.1.6 No 180° slow roll on vertical downward line for SZD-59 Acro and MDM 1 Fox on figures 8.6.1 to 8.6.8
- 1.14.1.7 No flick rolls on vertical downward lines for SZD-59 Acro on figures 8.6.1 to 8.6.8 in Columns 1,2 and 3.

A.14. Family 8.6.17 to 8.6.23 P-Loops with Half Rolls on Top

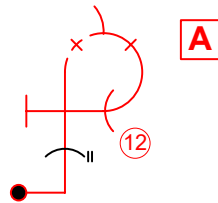
8.6.17.



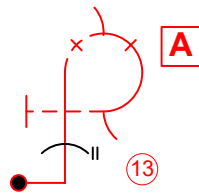
8.6.18.

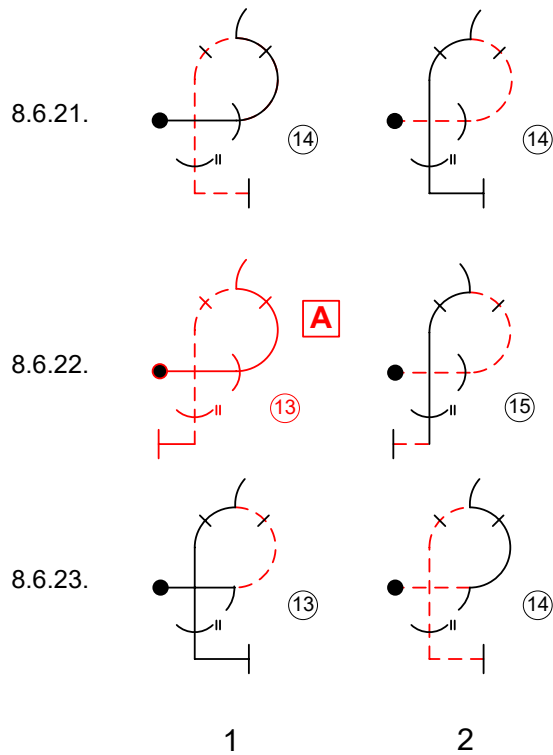


8.6.19.



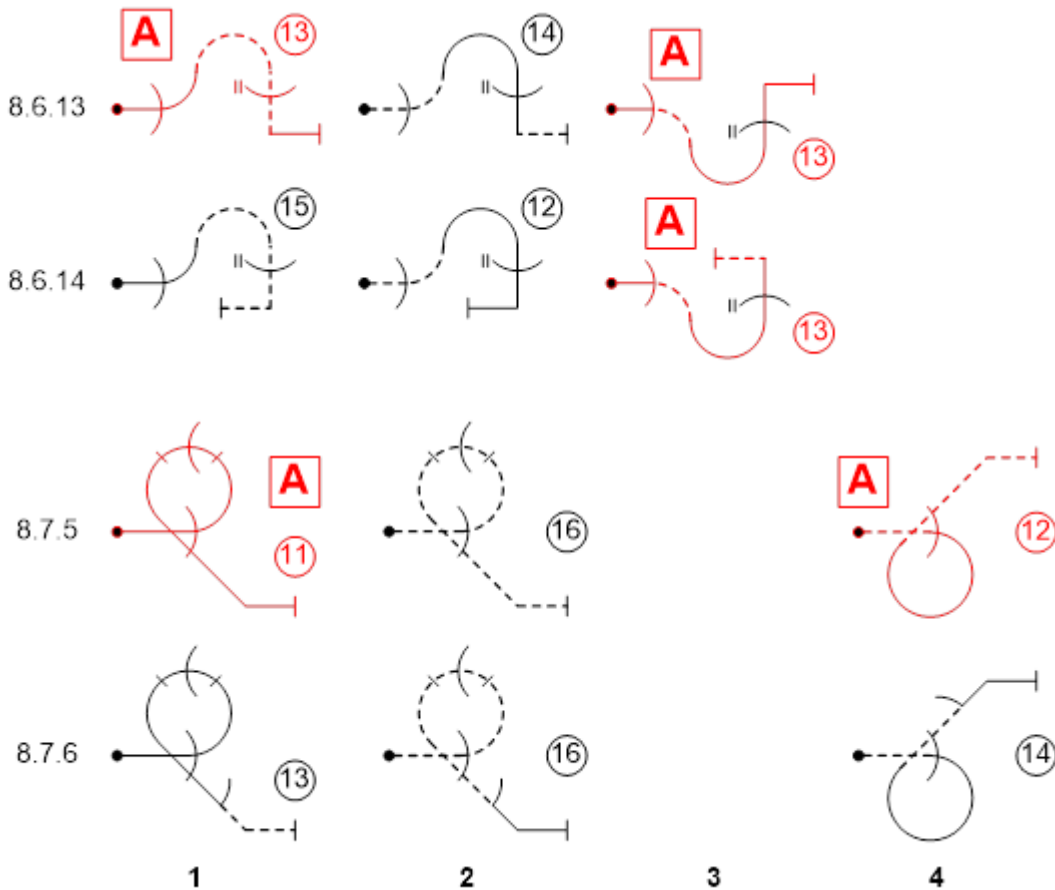
8.6.20.





- 1.14.1.8 No flick rolls on horizontal entry and exit lines of these figures
- 1.14.1.9 No hesitation rolls on top of figures 8.6.21.2, 8.6.22.2 and 8.6.23.1.
- 1.14.1.10 No 180° slow roll on vertical downward line for SZD-59 Acro and MDM 1 Fox on figures 8.6.21 to 8.6.23.
- 1.14.1.11 No flick rolls on vertical downward line for SZD-59 Acro on figures 8.6.21 to 8.6.23.

**A.15. Family 8.6.13, 8.6.14, Reversing P-Loops and Family 8.7, Q-Loops**



A.15.1.1 No more than one full roll on top of figures in columns 1 and 2 of 8.7.5.and 8.7.6

A.15.1.2 No flick rolls on horizontal entry lines of figures in columns 1 and 2.

A.15.1.3 No hesitation rolls on top of figures 8.7.5.2 and 8.7.6.2.

A.15.1.4 No flick rolls on the 45-degree downlines for 8.7.5.1, 8.7.5.2, 8.7.6.1 and 8.7.6.2.

A.15.1.5 No 180° slow roll on vertical downward line for SZD-59 Acro and MDM 1 Fox on figures 8.6.13 to 8.6.14.

A.15.1.6 No flick rolls on vertical downward line for SZD-59 Acro on figures 8.6.13 to 8.6.14.



A.16. Family 9.1, Aileron Rolls

| 9.1 |  | ¼      | ½      | ¾      | 1       | 1¼ | 1½      | 1¾ | 2       |
|-----|--|--------|--------|--------|---------|----|---------|----|---------|
| 1   |  | 9      |        |        |         |    |         |    |         |
| 2   |  |        | 9<br>A |        |         |    |         |    |         |
| 3   |  | 3<br>A | 6<br>A | 9<br>A | 12<br>A |    | 15<br>A |    | 18<br>A |
| 4   |  |        | 6<br>A |        | 12      |    |         |    |         |
| 5   |  | 3<br>A | 6      |        |         |    |         |    |         |
|     |  | 1      | 2      | 3      | 4       | 5  | 6       | 7  | 8       |

A.16.1.1 9.1.4.4 on negative 45° downward lines not permitted for SZD-59 Acro.

A.16.1.2 On vertical downward lines after flick rolls and spins not more than ¼ slow roll.

A.17. Family 9.2, 2-Point Rolls

| 9.2 |  |   |   |   | 1       |   | 1½ |   | 2 |
|-----|--|---|---|---|---------|---|----|---|---|
| 3   |  |   |   |   | 14<br>A |   |    |   |   |
|     |  | 1 | 2 | 3 | 4       | 5 | 6  | 7 | 8 |



A.18. Family 9.4, 4-Point Rolls


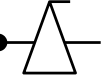

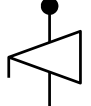

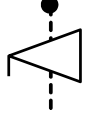
| 9.4 |  |   | $\frac{1}{2}$ | $\frac{3}{4}$ | 1       | $1\frac{1}{4}$ | $1\frac{1}{2}$ | $1\frac{3}{4}$ | 2 |
|-----|--|---|---------------|---------------|---------|----------------|----------------|----------------|---|
| 2   |  |   | 11<br>A       |               |         |                |                |                |   |
| 3   |  |   | 8<br>A        | 12<br>A       | 17<br>A |                |                |                |   |
| 4   |  |   | 8<br>A        |               |         |                |                |                |   |
|     |  | 1 | 2             | 3             | 4       | 5              | 6              | 7              | 8 |

A.19. Family 9.8, 8-Point Rolls

| 9.8 |  |  | $\frac{1}{4}$ | $\frac{1}{2}$ | $\frac{3}{4}$ | 1 | $1\frac{1}{4}$ | $1\frac{1}{2}$ | $1\frac{3}{4}$ | 2 |
|-----|--|--|---------------|---------------|---------------|---|----------------|----------------|----------------|---|
| 3   |  |  | 8<br>A        | 11<br>A       |               |   |                |                |                |   |
| 4   |  |  |               | 11            |               |   |                |                |                |   |
| 5   |  |  | 5<br>A        |               |               |   |                |                |                |   |



A.20. Family 9.9, Positive Flick Rolls

| 9.9 |   |          | ½        | ¾        | 1        | 1¼       | 1½       | 1¾       | 2        |
|-----|---|----------|----------|----------|----------|----------|----------|----------|----------|
| 2   |    |          | 15       |          |          |          |          |          |          |
| 3   |    |          | 12       |          | 16       |          |          |          |          |
| 4   |    |          | 12       |          | 16       |          |          |          |          |
| 5   |   |          | 12       | 14       | 16       |          |          |          |          |
| 8   |  |          | 15       |          |          |          |          |          |          |
| 10  |  |          | 12       | 14       | 16       |          |          |          |          |
|     |   | <b>1</b> | <b>2</b> | <b>3</b> | <b>4</b> | <b>5</b> | <b>6</b> | <b>7</b> | <b>8</b> |







A.20.1.1 Full horizontal positive flick 9.9.3.4 only at the apex of upward looping figures.

A.20.1.2 Positive half flick on negative line 9.9.8.2 only with catalogue numbers 7.2.2.2 and 7.2.4.1.

A.20.1.3 9.9.8.2 not allowed in Programmes 2 through 6.



A.21. Family 9.10, Negative Flick Rolls

| 9.10 |   |          | 1/2      | 3/4      | 1        | 1 1/4    | 1 1/2    | 1 3/4    | 2        |
|------|---|----------|----------|----------|----------|----------|----------|----------|----------|
| 2    |    |          | 18       |          |          |          |          |          |          |
| 3    |    |          | 15       |          |          |          |          |          |          |
| 4    |    |          | 15       |          | 19       |          |          |          |          |
| 5    |   |          | 15       | 17       | 19       |          |          |          |          |
| 8    |  |          | 18       |          |          |          |          |          |          |
| 10   |  |          | 15       | 17       | 19       |          |          |          |          |
|      |   | <b>1</b> | <b>2</b> | <b>3</b> | <b>4</b> | <b>5</b> | <b>6</b> | <b>7</b> | <b>8</b> |






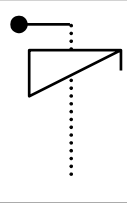
A.21.1.1 No inverted exit after more than 1/2 negative flick vertically down.

A.21.1.2 Negative half flick on positive line 9.10.8.2 only with catalogue numbers 7.2.2.1 and 7.2.4.2.






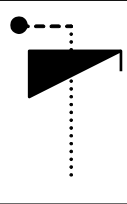
A.21.1.3 9.10.8.2 not allowed in Programmes 2 through 6.



A.22. Family 9.11, Positive Spins

|   |   |                       |   |   |   |   |   |  |
|---|---|-----------------------|---|---|---|---|---|--|
|   |   |                       |  |  |  |  |  |  |
|   |   |                       | 1   | 1¼  | 1½  | 1¾  | 2   |  |
| 1 |  | Upright<br>Entry Line |   |   | 5   | 6   | 7   |  |
|   |   |                       | A   | A   | A   |   |   |  |
|   |   |                       | 4   | 5   | 6   | 7   | 8   |  |

A.23. Family 9.12, Negative Spins

|   |   |                        |   |   |   |   |   |  |
|---|---|------------------------|---|---|---|---|---|--|
|   |   |                        |  |  |  |  |  |  |
|   |   |                        | 1   | 1¼  | 1½  | 1¾  | 2   |  |
| 1 |  | Inverted<br>Entry Line |   |   | 7   | 8   | 9   |  |
|   |   |                        | 4   | 5   | 6   | 7   | 8   |  |



**B. APPENDIX B: CRITERIA FOR JUDGING GLIDER AEROBATIC FIGURES**

**B.1. Preface**

B.1.1.1 The final mark awarded to a figure has many components, but first and most important in any mark is the geometry of the figure as compared to the true horizon and Aerobatic Box axes. Geometry is derived from two distinctly different entities: flight path and attitude.

B.1.1.2 Basic judging principles are the same in power and glider aerobatics; nevertheless, there are also some important differences. Compared to aerobatic aeroplanes, gliders have more restrictive operating limits in terms of speed as well as load factors. Most gliders have comparatively slow roll rates in aileron rolls as well as flicks. As most gliders have un-symmetrical wing sections, flight characteristics upright and inverted may differ considerably. All these factors lead to limitations in glider aerobatics, which should be considered, if glider figures and sequences are to be marked fairly.

**B.2. Definitions**

The following expressions are used consistently throughout the text in a very precise sense according to these definitions:

**B.2.1. Angle of Attack**

B.2.1.1 The angle at which the wings of an aircraft meet the relative airflow.

**B.2.2. Angle of Incidence**

B.2.2.1 The angle at which the wing is attached to the aircraft relative to the longitudinal axis.

**B.2.3. Figure**

B.2.3.1 Each individual component of a sequence, which may comprise one or more manoeuvres in combination; it starts and ends with a horizontal line.

**B.2.4. Manoeuvre**

B.2.4.1 Any one of the basic aerobatic movements, which may be combined to make a figure (e.g., an avalanche is one figure consisting of two manoeuvres – loop and flick roll).

**B.2.5. Mark/Point/Score**

B.2.5.1 Marks (from 0 to 10) are assigned by judges and may be devalued by various point values. The score is calculated by multiplying the judges' marks by the coefficients (K factors) and adding the products.

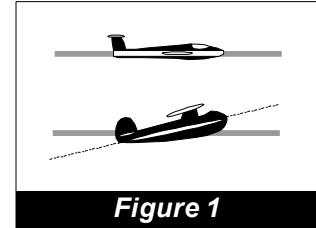
**B.2.6. Plane of Flight**

B.2.6.1 There are three planes of flight in aerobatic competition relative to the true horizon: horizontal, vertical and 45 degrees.

**B.3. Flight Path and Attitude**

**B.3.1. Flight Path**

B.3.1.1 Think of the aircraft condensed into a single dot and watch the path this dot takes through the sky. This is the flight path, or track, of the aircraft's centre of gravity. Judging the flight path or the track over the ground consists of comparing the observed path with fixed references such as the horizon or the main and secondary axes of the Aerobatic Box. (Figure 1)

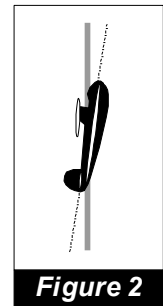


**Figure 1**

**B.3.2. Vertical Attitude**

B.3.2.1 Judging vertical lines is based on the attitude of the aircraft and not its flight path. When an aircraft's flight path, in a zero-wind condition, is exactly 90 degrees to the horizon, the wings are being held at the correct angle to produce no lift. The aircraft's attitude while in this condition (zero lift) defines the proper judging criterion for vertical attitude. This is called the zero-lift axis.

a) When this zero-lift axis is vertical, the longitudinal axis of some aircraft may not appear to be vertical. (Figure 2) This is especially true for most gliders; where, because the wing is attached at an angle of incidence of several degrees, and the aerofoil is not symmetrical, a negative angle is required to produce zero lift. The Judge must determine the proper vertical attitude for each aircraft type according to its zero-lift axis. The best opportunity to make this determination is to observe practice flights and note the different vertical attitudes, both up and down, of various glider types.

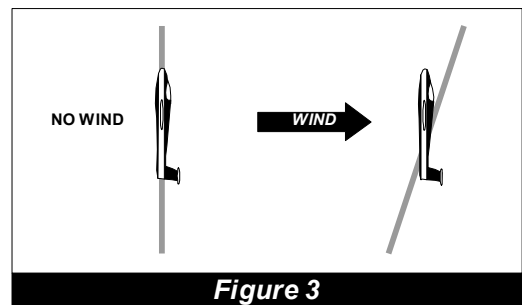


**Figure 2**

b) An aid for judging the perfect vertical (zero-lift) attitude is to observe vertical rolls. During a truly vertical roll, the aircraft's wings will constantly be parallel to the horizon, something which is especially noticeable after 90 degrees of roll.

c) Be aware that aircraft types whose zero-lift axis does not pass through the tail will make a spiral with the tail during a perfect vertical roll. From the Judges' perspective, this spiral will look as if the tail is shifting off-axis from the zero-lift axis flight path.

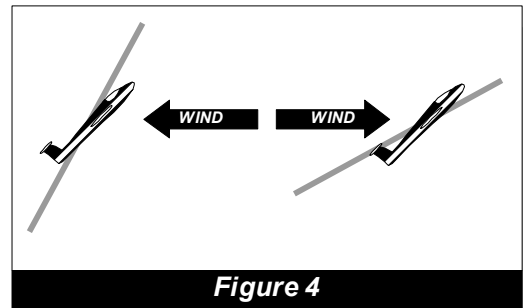
d) When there is a wind of any kind, the observed flight path will be offset from perpendicular to the horizon by some degree. This wind effect must be completely ignored by the Judge, who must only evaluate the accuracy of the vertical attitude. (Figure 3)



**Figure 3**

### **B.3.3. The 45 degree Attitude**

B.3.3.1 This is the vertical attitude plus or minus 45 degrees. In view of the difficulty in judging 45 degree lines accurately, scoring deductions should be applied with care. When flown into the wind, a perfect 45 degree line will appear to be steep while the opposite is true when flown downwind. (Figure 4) As with the vertical attitude, this wind effect must be completely ignored by the Judge who must only evaluate the accuracy of the 45 degree attitude.



B.3.3.2 Gliders gain airspeed on 45 degree down lines and lose airspeed on 45 degree up lines. When the pilot keeps the zero-lift axis at the prescribed 45 degree angle to the horizon, the flight path becomes flatter on the up line as lift decreases with airspeed as well as on the down line when lift is increased with increasing airspeed. These changes in the flight path angle must also be ignored when judging 45 degree lines. The prescribed deduction is one (1) point per five (5) degrees of deviation from the correct geometry (0.5 points per 2.5 degrees).

### **B.4. Marking**

B.4.1.1 It should be assumed that a competitor is going to fly a perfect figure, so a Judge starts with a mark of 10. As the figure is performed, the Judge then begins to find faults (if any) with what he or she sees and starts downgrading as the figure progresses. This system of marking is required by the rules as opposed to waiting until the figure is finished and assigning a mark based on overall impression. The latter causes the judging to be erratic and inconsistent.

B.4.1.2 Should a competitor fly a figure at a location, inside or outside the performance zone, such that the accuracy of the flight path or attitude cannot reasonably be determined, a downgrade of 2 points should be applied for each element of the figure that cannot be properly assessed.

### **B.5. Summary**

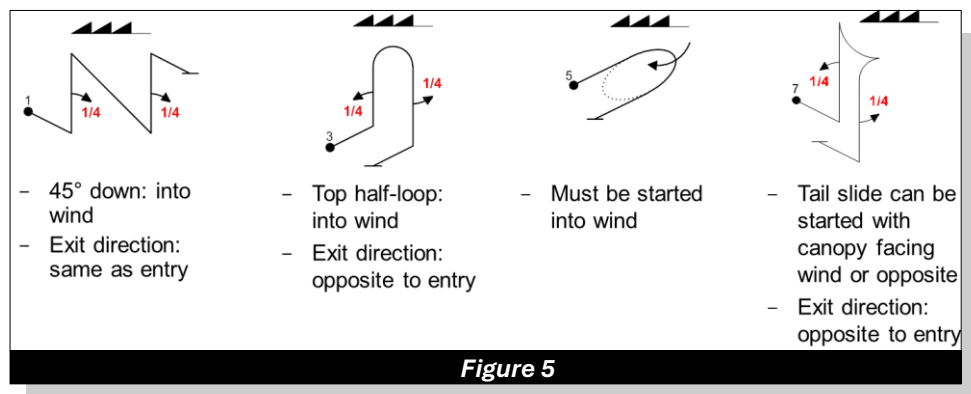
B.5.1.1 Remember, it is the Judge's job to find fault: be a nit-picker. On the other hand, give a mark of 10 if you see a perfect figure – but if you are really being critical, you won't see too many. Don't get in a rut. Guard against confining your marks in a too narrow range. If you watch carefully and mark consistently, you will find yourself giving an occasional 2, 3, or 4 on some sloppy figures that are not quite bad enough for a zero. You will also be giving an occasional 9 or 10 for the superlative figure with which you can find little or no fault. Take care not to mark on an overall impression of a flight. Be ready to award a low mark for a poor figure even if you have been marking other figures flown by that competitor with 8's and 9's.

B.5.1.2 On the other hand, when you see a competitor barely getting through the figures and you have been giving 4's and 5's, don't be afraid to award a 9 for the almost perfect 90 degree turn that you just saw.

B.5.1.3 Finally, and most importantly, only mark what you see. If you can't see anything wrong with a figure, don't deduct any points, even if you think there must be something wrong. Always give the competitor the benefit of the doubt.

**B.6. Box Axes**

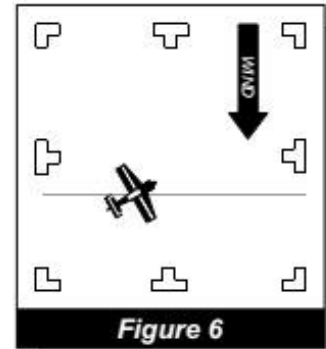
- B.6.1.1 At the entry and exit of every figure the aircraft longitudinal axis must be exactly aligned with either the main or secondary axis of the Aerobatic Box. Any angular deviations visible to the judge must be downgraded by one point per five degrees. Any angular deviations visible to the judge must be downgraded by one (1) point per five (5) degrees.
- B.6.1.2 Main axis directionality:
- The main axis is parallel to the official wind. Any figure with entry and/or exit lines aligned on the main axis must be flown with such entry and/or exit lines as drawn on sequence Forms B and C or L and R into or away from the official wind, otherwise the figure will be marked HZ.
  - Except for figures from Families 5 and 6: Any line segment within a figure, either straight or looping, drawn on the main axis, must be flown in the direction drawn on sequence Forms B and C or L and R into or away from the official wind, otherwise the figure will be marked HZ.
- B.6.1.3 The secondary axis is non-directional i.e. the pilot is free to choose direction when transiting from the main to the secondary axis.
- B.6.1.4 Any figure with both entry and exit lines aligned on the secondary axis must be drawn with parallel entry and exit lines.
- B.6.1.5 Any figure with both entry and exit lines aligned on the secondary axis must be flown with the exit direction relative to the entry direction as drawn on sequence Forms B and C or L and R, i.e. in the same or the opposite direction, otherwise the figure will be marked HZ



**B.7. Wind Correction**

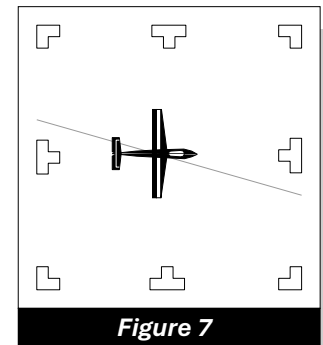
- B.7.1.1 There are two kinds of wind correction: correction for figure geometry (shape) and correction for Aerobatic Box positioning.
- B.7.1.2 The competitor is required to make the shape of all loops and part-loops within a figure perfectly round as seen by the judge on the ground. Wind correction is required for loops and part-loops within figures so that the aircraft's flight path describes a constant radius circle or part circle. Remember, the Judge marks for the roundness of the flight path. Any deviation from perfect roundness must result in a reduction of the mark for that figure.

B.7.1.3 The competitor is also required to keep the aircraft within the Aerobatic Box. This becomes more of a problem when a wind is blowing at an angle to the main axis. The primary method of dealing with cross-box drift is to include a "wind corrector" figure in the sequence. A wind corrector is a figure which places the aircraft onto the secondary axis. Because the secondary axis is non-directional, the competitor can turn onto the secondary axis in the direction which will allow an upwind position change before flying a subsequent figure which returns the aircraft to the main axis.



B.7.1.4 A well-designed sequence will always include at least one, and preferably more, wind corrector figures. Not every Compulsory Programme contains sufficient (or any) wind corrector figures. In this case, it is up to the competitor to keep the aircraft within the Aerobatic Box without benefit of a specific secondary axis figure to accomplish it.

B.7.1.5 A common flight mode is to crab into the wind as done in navigational flight. (see Figure 6) Crabbing means that the aircraft's longitudinal axis is at an angle to the track over the ground. The downside to this approach is that if the aircraft longitudinal axis is detected by the Judge to be at an angle to the competition axis (main or secondary), one (1) point per five (5) degrees must be deducted.



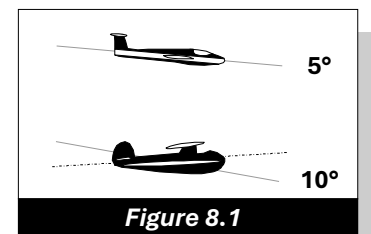
B.7.1.6 It is possible for the competitor to correct for wind in such a manner that the aircraft longitudinal axis remains true to the correct geometry of the figure but the flight path has a sideways component. (Figure 7) If there is no deviation in the aircraft longitudinal axis or bank angle visible to the Judge, then no mark must be deducted.

**B.8. The Two Basic Components of Aerobatic Construction: Lines and Loops**

**B.8.1. Lines**

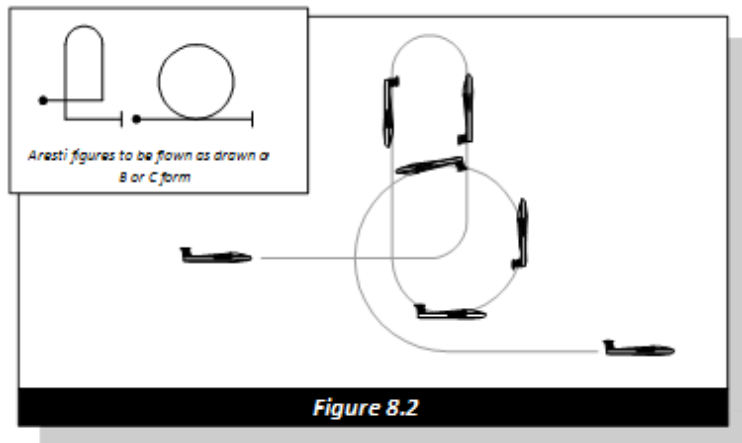
B.8.1.1 All lines are judged in relation to the true horizon and the Aerobatic Box axes. Horizontal lines are judged on flight path, not attitude. Different aircraft at different airspeeds will employ different attitudes to maintain a horizontal flight path. (see Figure1)

B.8.1.2 Gliders cannot maintain altitude without losing speed. In order to maintain airspeed, they must fly a descending flight path. The glide angle at constant airspeed is determined by the lift/drag ratio of the specific glider at that speed. So, depending on airspeed and glider type, glide angles may vary considerably.(Figure 8.1) For this reason, the flight path for horizontal lines in glider aerobatics may be inclined between zero (0) and ten (10) degrees below the horizon. Deviations above or below this bracket will be downgraded by one (1) point per five (5) degrees.

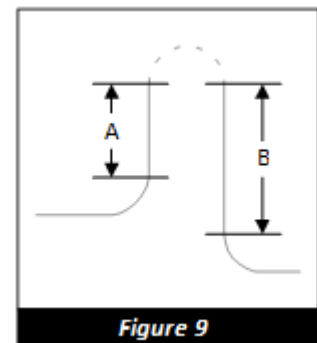


B.8.1.3 While maintaining a horizontal flight path, the aircraft's longitudinal axis must remain parallel to the X or Y axis. The deduction for deviation in either axis is one (1) point per five (5) degrees from the correct geometry.

B.8.1.4 All figures begin and end on definite horizontal lines, and both must be present in order to earn a good mark. A competitor who rushes from one figure to another without showing this horizontal and well-recognizable line will be downgraded by one (1) point for each missing line in each figure affected. Therefore, leaving out the line between two figures will downgrade the preceding figure by one (1) point and the following figure by one (1) point. (Figure 8.2)

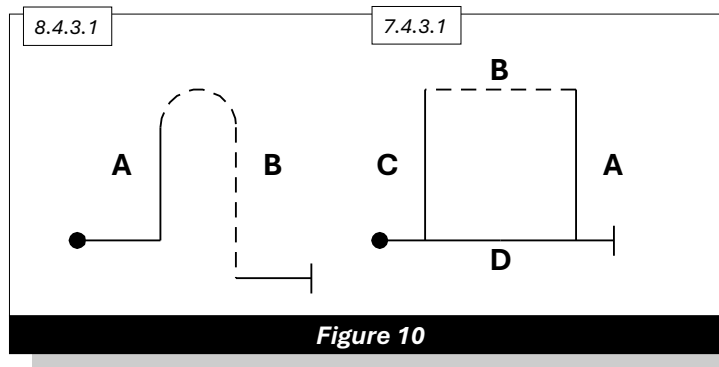


B.8.1.5 All lines that occur inside a figure are preceded and followed by part-loops. (Figure 9) The absolute length of lines within a figure is in itself not a marking criterion. The corresponding attitude of vertical or 45° inclined lines must be maintained long enough to allow judges to observe the angle and determine any deviations from the prescribed attitude. Varying the attitude whilst flying a vertical or 45° inclined line must be downgraded by at least one (1) point per line. The same applies to deviations from a straight flightpath when judging horizontal lines.



B.8.1.6 Excessively long lines and "rough" flying with high-G "square corners" must not be rewarded with higher marks.

B.8.1.7 With the exception of Family 3 figures and some figures in Family 7, the criterion for the length of lines within a figure states that they do not have to be of equal length. Therefore, it is imperative that the judges become familiar with the specific criterion for the length of lines for each figure. For example, the lines in a "Humpty-bump" do not need to be of equal length, but all four lines in a "Square Loop" must be of equal length. (Figure 10)



B.8.1.8 Whenever an aileron roll or hesitation roll is placed on an interior line, the lengths of the two parts of the line before and after the roll must be equal. In gliders, the entry airspeeds for positive and negative flick rolls lie in a relatively narrow bracket. Pilots must be free, therefore, to determine the point on the line where they start the flick roll. Because of this, no deduction will be made for flick rolls not centred on an interior line. The line lengths before and after a roll are not a marking criterion when rolls are performed on a 90 degree down line following a spin.

B.8.1.9 Some gliders have relatively slow roll rates and need practically the entire length of an interior line to complete an aileron roll or hesitation roll. Therefore, it is sufficient to fly vertical or 45 degree lines before and after the roll just long enough to show that the preceding part-loop has been completed

and the prescribed plane of flight is established. The absolute lengths of the lines before and after the roll are irrelevant for marking as long as they are equal.

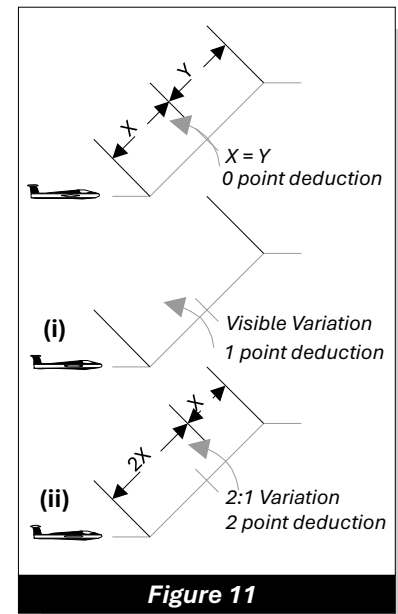
B.8.1.10 Judges should take care to judge the symmetry of the length of lines in a figure using only the length of the lines and not by elapsed time taken to fly each segment. This difference in length versus elapsed time is most noticeable in figures where rolls are placed on up-lines. As the aircraft loses airspeed, the time it takes to fly a line after the roll will be longer than the time required to fly the line of the same length before the roll.

B.8.1.11 If within a figure two or more lines must be of the same length, an observed variation is penalised by reducing the mark in the following manner: (Figure 11)

- a) a visible variation - one (1) point deduction
- b) if the lengths vary by 1:2 or more - two (2) points deduction.

B.8.1.12 The basis for judging line lengths is the first line flown. The absence of one of the lines before or after a roll is penalised by one (1) additional point.

Example: The competitor is to fly a 45 degree up-line with a half aileron roll on this line. Although there was a line before the roll, the glider was returned to level flight immediately after the roll. The correct deduction is three (3) points: two (2) points are deducted because the lengths of the lines differ by more than 1:2, and another one (1) point is deducted because of the absence of one of the lines.



**Figure 11**

B.8.1.13 All 90 degree and 45 degree lines are preceded by a part-loop. When the glider completes the part-loop and reaches the prescribed plane of flight, the pilot must reduce the angle of attack to maintain the 90 degree or 45 degree attitude. For marking purposes, the judge must only look for the precise alignment of the glider's zero lift axis 45 degrees or 90 degrees relative to the horizon as soon as the part-loop has been completed.

B.8.1.14 Some pilots exaggerate the change in angle of attack when transitioning from loop to line. They overshoot the correct attitude by several degrees, and then the nose of the glider is "bumped" back onto the line. This must be downgraded by one (1) point for every five (5) degrees.

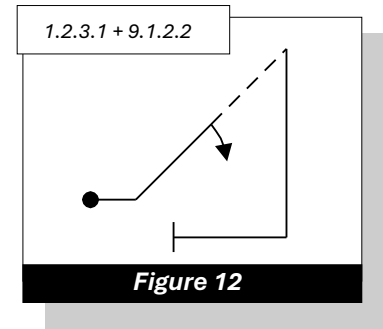
**B.8.2. Loops and Part Loops**

B.8.2.1 All transitions from one plane of flight to another should have a reasonable and constant radius. The size of that radius is not a marking criterion, and higher marks must not be given for high-G "square corners". If a stall occurs in a loop or part loop, the deduction is 4,0 p.

B.8.2.2 The loop is a figure from Family 7, but part-loops are integral to most other families, so it is necessary to define some key elements before going on to the other families.

- a) A loop must have, by definition, a constant radius. It starts and ends in a well-defined line which, for a complete loop, will be horizontal. For a part-loop, however, such lines may be in any other plane of flight and will be defined by the aircraft's attitude. As the speed changes during execution of a loop or part-loop, the angular velocity around the aircraft's lateral axis also has to change in order to keep the radius constant. Thus, the angular velocity can be an aid for the judge to gauge the radius – especially when the angular velocity in the higher part-loop is seen to be faster, as this is a clear indication that the radius is smaller. This aid becomes more important when two part-loops are separated by a line between.

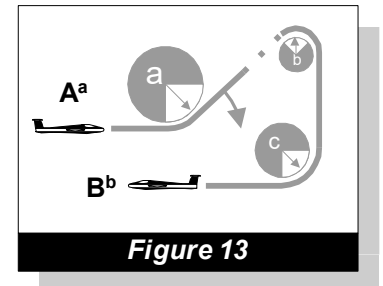
- b) Part-loops are depicted either as round elements or as 'corner' angles. It should be noted that any 'corner' angle drawn in the pictograms, such as in Figure 12, is always to be flown as a part-loop and must have a smooth, distinct and constant radius.
- c) For any one figure having several internal part-loops depicted as round elements, all such part-loops shall have the same radius – with exception for all of family 8.8 figures (double humpty-bumps) for which the radius of the second part-loop is not required to match the radius of the first one.
- d) The radius of any part-loop depicted as a corner angle is not required to match the radius of any other part-loop in the same figure – with exception for all of Family 3 (combinations of lines) and Family 7.4 (hesitation loops) figures, which must keep a regular geometrical shape and therefore require all part-loops to have the same radius.



## **B.9. Aresti System (Condensed) Glider Families**

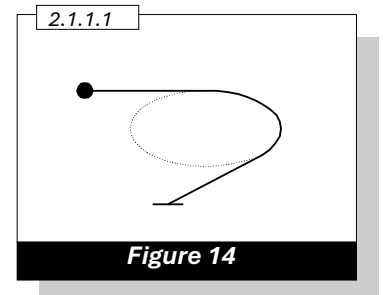
### **B.9.1. Family 1 – Lines and Angles**

- B.9.1.1 Family 1.1.1 to 1.1.11 has been fully covered in the preceding section. Note that the figures in Family 1.2.1 to 1.3.1 are NOT performed as drawn in the Catalogue (Figure 12). In each of these figures there are three (four in 1.3.1 - 1.3.8) looping components: a one-eighth loop, a three-eighths loop and a quarter loop. (Figure 13) Rolls may be performed on the 45 degree line and/or the 90 degree line, with the part-lines before and after the roll being of equal length, except positive or negative flick rolls and rolls following a spin.
- B.9.1.2 The initial horizontal line and the line at the end of the figure may be flown at different altitudes.
- B.9.1.3 Figure 13 shows Family 1.2.1-1.2.8 as flown. Radii a, b, and c may all be different and entrance altitude "A" can be different from exit altitude "B".



### **B.9.2. Family 2.1.1, 2.2.1, 2.3.1 and 2.4.1 – Turns**

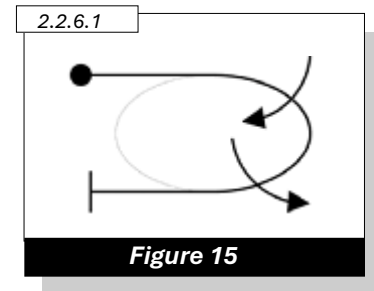
- B.9.2.1 Competition turns are not to be confused with standard coordinated turns (Figure 14). In aerobatic competition, a turn is divided into three parts:
  - a) establishing the bank using a roll on heading.
  - b) the turn itself; and
  - c) a roll back to straight and level flight on heading.
- B.9.2.2 First, the roll to establish the bank. This must be a roll of 60 degrees, it must be performed on the entry heading, and the aircraft must maintain a constant glide (0 to 10 degrees below the horizon).
- B.9.2.3 Once the roll is completed and the angle of bank is established, the competitor immediately performs the turn. The turn must maintain 60 degrees of bank throughout. The aircraft must also maintain a constant glide (0 to 10 degrees below the horizon). The rate of turn is constant throughout and is NOT wind corrected. Therefore, in wind, a 360-degree turn will not appear as a perfect circle.



- B.9.2.4 As soon as the glider is on the exit heading, the competitor performs another roll at a rate equal to the entry roll. Again, the aircraft must maintain a constant glide (0 to 10 degrees below the horizon).
- B.9.2.5 Downgrades:
- The angle of bank established by the initial rolling manoeuvre must be exactly 60 degrees. Any deviation is a one (1) point deduction for every five (5) degrees.
  - The angle of bank, once established, must remain constant. Any deviation is a one (1) point deduction for every five (5) degrees of deviation.
  - The rate of roll must be the same for the entry and exit rolls of this figure. Any deviation is a one (1) point deduction.
  - The aircraft must maintain a constant glide (0 to 10 degrees below the horizon) throughout the figure. Any deviation above or below is one (1) point for every five (5) degrees.
  - The rate of turn must remain constant. Any change would be not more than a one (1) point deduction for each change. Note that the rate of turn may appear to change in a strong wind, when it really isn't changing. The Judge must always keep the wind in mind and give the pilot the benefit of the doubt if there is any question.
  - The aircraft must begin and end on the prescribed heading. Any deviation is a one (1) point deduction for every five (5) degrees of deviation.

**B.9.3. Family 2.1.2, 2.1.3, 2.2.2 - 2.2.6, 2.3.2 -2.3.5 and 2.4.2 - 2.4.8 – Rolling Turns**

B.9.3.1 The rolling turn (Figure 15) combines a level turn of a prescribed amount with a roll or rolls evenly integrated throughout the turn. The term “evenly integrated” means that from start to finish the figure should display a constant rate of turn combined with a constant rate of roll.

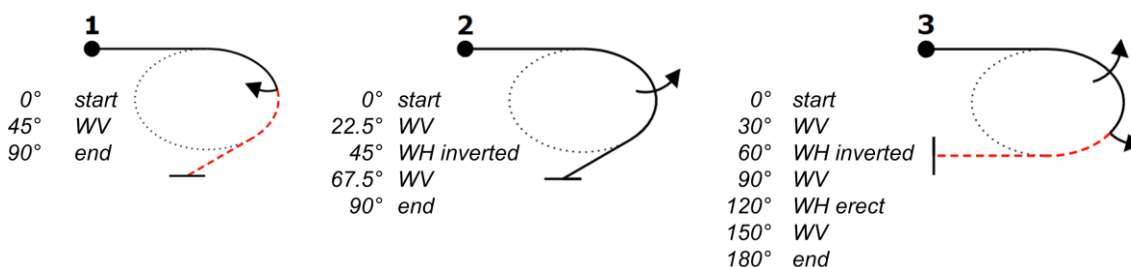


**Figure 15**

B.9.3.2 As seen from the ground, rolls in the same direction as the turn are referred to as “rolls in” or “rolling inwards”. Rolls in the opposite direction to the turn are described as “rolls out” or “rolling outwards”.

B.9.3.3 Between the start and end of a rolling turn one or more intermediate points occur when the aircraft wings are momentarily either vertical or horizontal. A simple interpretation is that the intermediate points occur at the half, quarter or one-third positions in each 90 degrees of turn. For example, these can be –

Here: “WV” = wings vertical, “WH” = wings horizontal





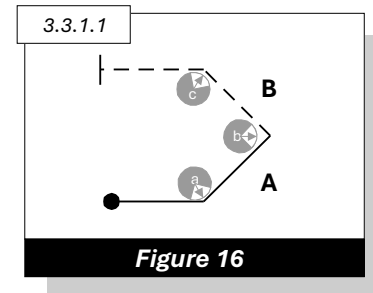
- B.9.3.4 When a rolling turn has rolls of alternating directions, the aircraft must change the direction of roll with the wings level. At this point the roll should reverse direction with only a short pause; a longer pause must be downgraded.
- B.9.3.5 For example, imagine an aircraft performing a 180 degree rolling turn with 1 roll inwards and one roll outwards from upright (see Figure 15 - Aresti 2.2.6.1):
- a) The figure starts with the wings level and the aircraft longitudinal axis aligned with the prescribed box axis.
  - b) The pilot simultaneously initiates the turn and commences the roll in the same direction as the turn.
  - c) The judge should expect the aircraft wings to be vertical or horizontal at precisely each intermediate point in the turn.
  - d) Throughout the figure the judge should note any detectable variations in the rate of roll, the rate of turn and the constant glide path.
  - e) The roll direction should be reversed from inwards to outwards with only a short pause when the turn angle reaches 90 degrees. The rate of roll before and after the reversal should remain constant.
  - f) The turn is not wind corrected and for this reason may not follow a circular flight path.
  - g) The figure ends when the aircraft longitudinal axis reaches alignment with the prescribed box axis, at the moment the wings become level.
- B.9.3.6 Downgrades:
- a) The aircraft must commence the figure with the wings level, in a constant glide and with the longitudinal axis aligned with the correct box axis. Errors are deducted using one (1) point for every five (5) degrees.
  - b) Variations from the constant glide (0 to 10 degrees below the horizon) are deducted by one (1) point per five (5) degrees.
  - c) Each variation in the rate of turn is no more than a one (1) point deduction. Each stoppage of the rate of turn is a deduction of two (2) points.
  - d) Each variation in the rate of roll is no more than a one (1) point deduction. Each stoppage of the rate of roll is a deduction of two (2) points.
  - e) At a roll direction reversal there must be only a short pause, with the wings level. A longer pause is no more than a one (1) point deduction. Errors in the roll angle from wings level are deducted using one (1) point for every five (5) degrees.
  - f) Each time the wings are vertical or horizontal, a deviation between the aircraft longitudinal axis and the correct amount of turn at this point is a deduction is no more than one (1) point.
  - g) All rolls in a rolling turn are aileron or slow rolls. If a flick roll is performed, the figure is graded HZ.
  - h) Performing more or fewer rolls than the catalogue stipulates or incorrectly rolling either inwards or outwards must be graded HZ.
  - i) The figure is completed when the aircraft stops rolling, or its longitudinal axis reaches the prescribed box axis. Errors when the exit point is reached are penalised as follows:
    - i) Where the turn angle is less or more than required the deduction is one (1) point per five (5) degrees.

ii) Where continued rolling is seen to bring the wings level after the turn is completed the following deductions should be applied:

- Less than 15 degrees of roll is executed: 1 point
- Between 15 degrees and 30 degrees of roll is executed: 2 points
- Between 30 degrees and 45 degrees of roll is executed: 3 points
- Between 45 degrees and 90 degrees of roll is executed: 0,0 points
- More than 90 degrees of roll is executed: HZ

**B.9.4. Family 3 – Combinations of Lines**

B.9.4.1 The transition from level flight to 45 degree lines should be at a constant and reasonable 1/8th looping radius. All lines within the figure must be equal in length. All part-loops in family 3 shall have the same radius. (In Figure 16; radii  $a = b = c$ )

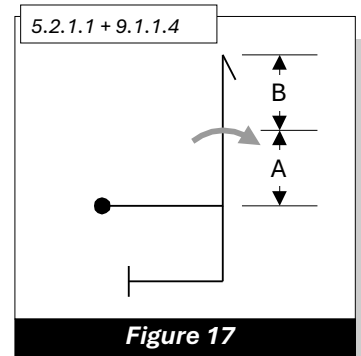


**B.9.5. Family 5 – Stall Turns**

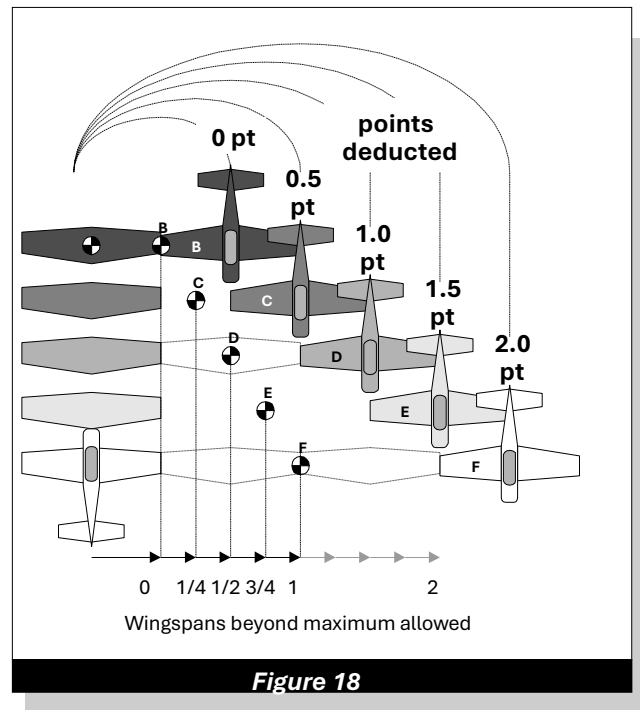
B.9.5.1 In its most basic form, the figure begins when the aircraft leaves horizontal flight and flies a quarter loop to establish a vertical climb. At the top of the vertical line, the aircraft pivots and establishes a vertical descent, with the figure ending as the aircraft is returned to horizontal flight.

B.9.5.2 The judging criteria are:

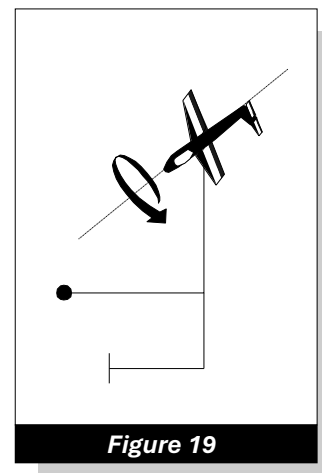
- a) The vertical lines, both up and down, must be flown on the zero-lift axis. (see Figure 2)
- b) Any deviation from vertical, either up or down, will result in a deduction of one (1) point per five (5) degrees from the zero-lift axis.
- c) Any added roll(s) must be in the vertical climb or vertical descent and positioned so that the lines before and after the roll are of equal length (except positive or negative flick rolls) (Figure 17). For deductions see B.8.1.11 and B.8.1.12.
- d) The length of the vertical up and down lines need not be equal. As such, the altitude of the horizontal lines at the start and finish of the stall turn may be different.
- e) During the vertical climb or vertical descent, the wings must remain parallel to the horizon. There will be a one (1) point deduction per five (5) degrees, when the line connecting both wing tips deviates from horizontal.
- f) As the glider nears the point where it would stop climbing, it must pivot in a plane parallel to vertical. To avoid a deduction, it must pivot around a point which should not be farther away from its centre of gravity than its wingtip. When the radius of the rotation is greater, the downgrade is one (1) point per half wingspan. (Pivot point D, Figure 18)
- g) The rate at which the aircraft pivots around its vertical axis is not a judging criterion. If, however, the glider slides down sideways whilst pivoting around its vertical axis, this "wing slide" must be downgraded by at least one (1) point depending on the severity of the slide.
- h) The wings must remain in the vertical geometric plane throughout the turnaround, and the aircraft's attitude before and after the turnaround must be absolutely vertical, with no pitch or roll. There must be no rotation around the longitudinal or lateral axes. If there is movement around any axis other than the yaw axis, often referred to as "torquing" (Figure 19), there is a deduction of one (1) point for each five (5) degrees off axis.



**Figure 17**



**Figure 18**



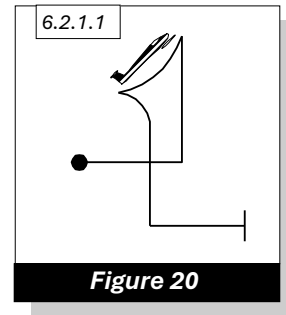
**Figure 19**

**B.9.6. Family 6 – Tailslides**

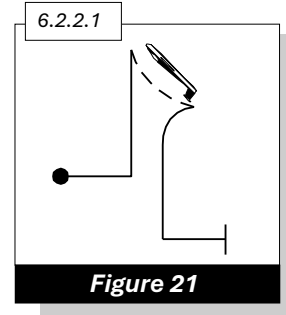
B.9.6.1 All the criteria of the Stall Turn apply to this figure except, of course, for the manoeuvre at the top of the vertical climb. At the point when the aircraft stops, it must slide backwards a visible amount (the key here is "a visible amount"). If a tailslide does not move backwards the reduction is -4,0 p.

B.9.6.2 Following the slide backwards, the aircraft must then tip over and fall through to a diving position. The tipping over must be around the lateral axis only. Any movement around another axis is downgraded by one (1) point per five (5) degrees.

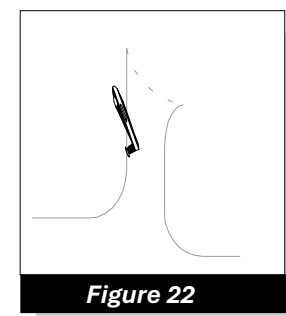
B.9.6.3 Often the nose will swing back or "pendulum" past the vertical after falling through. The figure is not to be downgraded for this, nor downgraded if it does not happen. It is a function of the length of the slide and the type of aircraft and is not to be considered in marking the figure.



B.9.6.4 There are two types of tailslide: wheels-down (also called "canopy-up") and wheels up (also called "canopy-down"). The wheels-down tailslide is depicted in the Aresti diagram with a curved solid line at the top of the tailslide symbol. (Figure 20) The wheels-up tailslide is depicted in the Aresti diagram with a curved dashed line at the top of the tailslide symbol. (Figure 21) This figure must be watched carefully, as the aircraft can fall the wrong way (which is marked Hard Zero) with the correct direction of flight and the proper aircraft attitude still maintained. Wings should stay level with the horizon throughout and not drop during the slide or the fall through. Watch for the aircraft rolling off the correct plane of flight, which must be downgraded.



B.9.6.5 Also watch for "cheating" on the vertical line up in the direction of the slide just prior to sliding. (Figure 22) The entry quarter loop and the exit quarter loop must be flown with reasonable and constant radii. The altitude of the entry and exit horizontal lines need not be the same and the radii of the entry and exit quarter loops may be different.



B.9.6.6 When rolls are combined with Family 6 figures, there must be an equal length of line before and after the roll(s) (except positive or negative flick rolls). In the vertical down line, the aircraft must attain a vertical attitude and establish a down line before starting the roll(s).

B.9.6.7 In summary, the aircraft should make a smooth and steady transition up to vertical flight, the wings should stay level in relation to the horizon, and the aircraft should come to a complete stop in this attitude. After sliding backward a visible amount, it should fall through in the appropriate direction without dropping a wing or the nose moving off axis and recover on the same plane as that of entry. After completion of this, it should again project the 90 degree down line before transitioning into horizontal flight with a quarter loop of reasonable and constant radius.

**B.9.7. Family 7 – Loops and Figure 8's**

B.9.7.1 The size of a loop is not a marking criterion. It will vary according to the flight characteristics of the aircraft. A large loop is not marked any higher or lower than a small loop. But any variation to the radius will downgrade these figures.

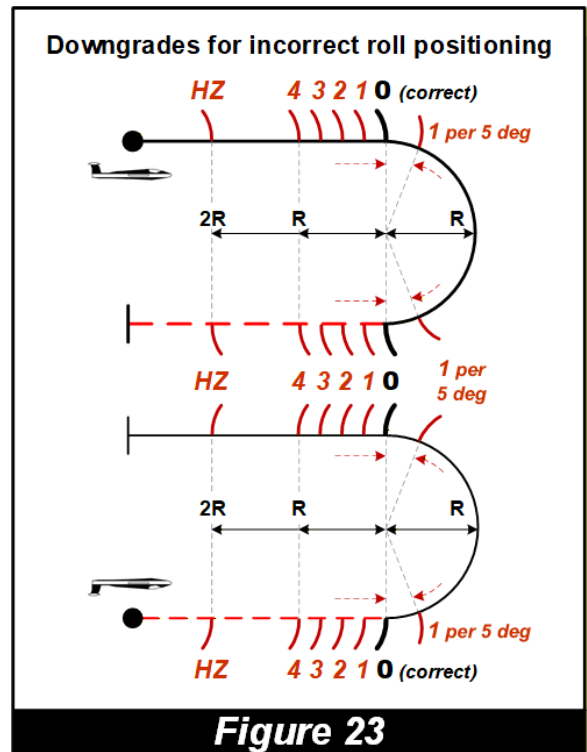
**B.9.8. Combination of loop elements with rolls on horizontal lines**

B.9.8.1 The following principles for downgrading unwanted lines between rolls and looping segments must be applied in the same manner when rolls are placed adjacent on a horizontal line to looping segments in the following families of figures:

- Family 7.2 Half loops with rolls
- Family 7.4 Reversing whole loops
- Family 7.5 Horizontal S's
- Family 7.8 Horizontal 8's
- Family 8.5 Half Cuban eights
- Family 8.6 P-loops and reversing P-loops
- Family 8.7 Q loops
- Family 8.10 Reversing 1¼ loops

B.9.8.2 When a looping segment is preceded or followed by a roll or rolls, the two figure elements must be flown without a visible line between them. Drawing a line requires a downgrade which depends on the length of the line drawn. The downgrade is determined by comparing the line length with the loop radius (R). Figure 23 is an example for family 7.2:

- a) One (1) point for a short but visible line.
- b) Two (2) points for a more obvious line, with a length up to the half radius (1/2R) of the loop segment.
- c) Three (3) points for a longer line, which is longer than the half radius (1/2R), but shorter than the full radius (R) of the loop segment.
- d) Four (4) points for an even longer line, which is as long as one radius (R), but not longer than two radii (2R) of the looping segment.
- e) If the visible line between the loop segment and the end of the preceding / start of the following roll element has a length of two radii (2R) or more of the loop segment, then the figure must receive a mark of HZ, giving the reason "Wrong figure" (describe missing figure element).

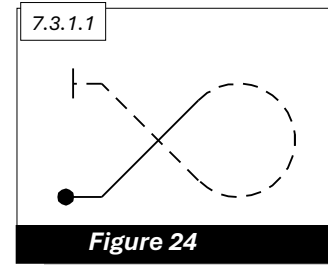


**Figure 23**

B.9.8.3 Should the loop segment begin before the roll is completed, or the roll begin before the loop segment is completed, the Judge must downgrade the figure one (1) point for every five (5) degrees of loop arc flown on which the roll was performed (Figure 23).

**B.9.9. Family 7.3 – Three Quarter Loops**

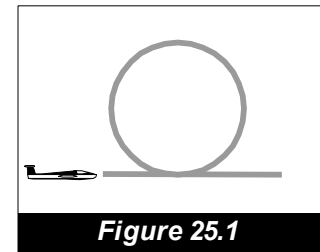
B.9.9.1 Sometimes referred to as "Goldfish", none of the part-loops in these figures need be of the same size. Entry and exit lines are judged with reference to the 45 degree attitude, not flight path. Any rolls, except positive or negative flick rolls on the 45 degree lines must be centred on that line. The lengths of the two 45 degree lines may be different and the entry and exit altitudes need not correspond to the altitude limits of the loop. (Figure 24)



**Figure 24**

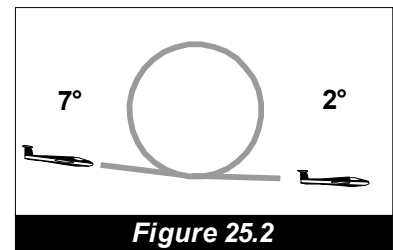
**B.9.10. Family 7.4.1 - 7.4.2 – Round Loops**

B.9.10.1 All full loops must appear perfectly round to the Judge. This means that they must be wind corrected to have a constant radius. This wind correction is only with regards to the roundness of the loop and not for the effect of any crosswind on the figure. Therefore, no deduction is given if the finish point is displaced relative to the start point in a direction perpendicular to the plane of the loop. Full loops must also begin and end at the same altitude or they will be downgraded. (Figure 25.1)



**Figure 25.1**

B.9.10.2 In glider aerobatics, the entry and exit lines of the loop may be inclined 0 to 10 degrees below the horizon and the inclination may be different for entry and exit lines within the above tolerances (Figure 25.2).



**Figure 25.2**

B.9.10.3 Loops must be flown with no visible crabbing and wings must be level at all times. The one (1) point for every five (5) degrees rule holds for both these cases.

B.9.10.4 If there is a roll or rolls at the apex of the loop, it must be centred in the loop and flown on the arc of the loop itself. Flying the roll on a line at the apex of the loop is at least a two (2) point downgrade. If the roll is not centred, it must be downgraded one (1) point for every five (5) degrees of the arc that it is off centre.

B.9.10.5 To better quantify deductions for irregularity of the radius of looping figures, the Judge divides the loop into quadrants. Any recognizable variation in the radius must be downgraded by a maximum of two (2) points per quadrant depending on the magnitude of the variation.

**B.9.11. Family 7.4.3 - 7.4.6 – Square, Diamond and Octagon Loops**

B.9.11.1 Square and Octagon loops are flown as hesitation loops with lines of equal length and partial loops with equal radii. All horizontal lines are judged on flight path and vertical and diagonal lines are judged based on aircraft attitude. As such, except in a windless condition, the judge should never expect to see these figures closed. They will always be driven by the wind. Square and Octagon loops are not considered complete until the last horizontal line is drawn equal to the length of the first line of the figure.

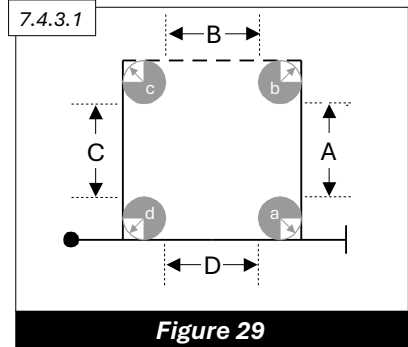
**Figure 29**

Radii  $a = d$  and  $c = b$

Line Length  $A = B = C = D$

Figure is not complete until  $D = A$

The top radii may be different than the bottom radii (while still requiring the two top radii to be equal and the two bottom radii to be equal).



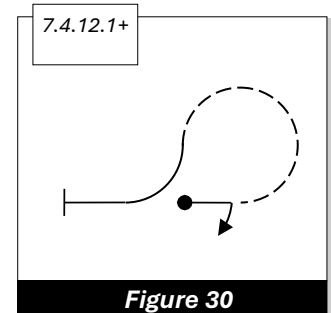
B.9.11.2 Where rolls are flown on Square or Diamond loops, they must be centred on the line (except positive or negative flick rolls).

B.9.11.3 Aids for judging all hesitation loops are that a good performance will contain changes of angular velocity in all the partial loops, and variations of time taken to draw the length of each interior line, which also varies according to the aircraft's speed. The rhythm of all these partial loops is a help for judging. A frequently seen error in hesitation loops is for the aircraft to overshoot the partial loop and then have to bring the nose back to correct the attitude. This must be downgraded by one (1) point for every five (5) degrees.

**B.9.12. Family 7.4.7 - 7.4.14 – Reversing Whole Loops**

B.9.12.1 Judging criteria for roundness are the same as for round loops (see B.9.10): The reversing loop must be wind corrected with all partial loops having the same radii.

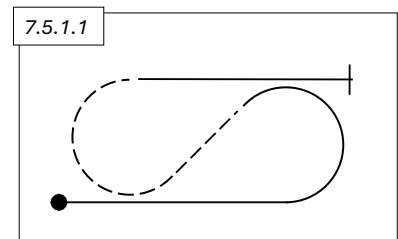
B.9.12.2 The reversing loop must be a continuous looping figure with no line at the point where the pitch direction changes. Adding a line between the two partial loops is at least a two (2) point deduction depending on the length of the line.



B.9.12.3 Criteria for rolls on entry and exit lines are the same as for half loops (see B.9.8). Criteria for rolls at the apex of the loop are the same as for round loops (see B.9.10).

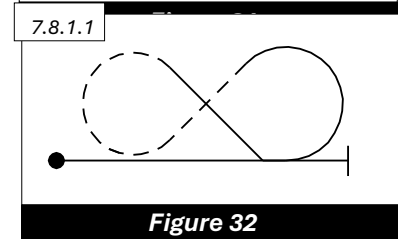
**B.9.13. Family 7.5.1 - 7.5.8 – Horizontal S's**

B.9.13.1 Both looping segments must have the same radius. For rolls on the horizontal entry and exit lines the criteria for Family 7.2 apply. Rolls on the internal 45 degree line must be centred except positive or negative flick rolls.



**B.9.14. Family 7.8.1 - 7.8.8 – Horizontal 8's**

B.9.14.1 The 5/8 and 3/4 loops must have the same radius, but the radius of the 1/8 loop between 45 degree and horizontal line need not equal the radii of the other loops. The lines between the loops are flown at exactly 45 degrees attitude. Rolls on the 45 degree lines must be centred except positive or negative flick rolls. For deductions see B.8.1.11 and B.8.1.12.



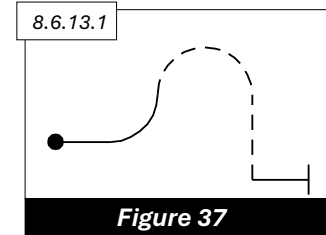
B.9.14.2 The start and finish of the figure and the bottoms (or tops if the figure is reversed) of the two loops need not be at the same altitude. For rolls on the horizontal entry or exit lines before or after the 5/8 loop, the criteria for half loops apply. (Figure 32)



**B.9.20. Families 8.6.9 - 8.6.16 and 8-10 – Reversing P-Loops and Reversing 1¼ Loops**

B.9.20.1 When 1/4, 1/2 and 3/4 loops depicted as round elements join each other in these Families, their radii must be equal and there is no line between the loops. (Figure 37)

A line drawn would be a minimum two (2) point deduction depending on the length of the line. The part-loop depicted as a corner angle, should have a reasonable radius, but need not match the other looping radii. For rolls on the entry and exit lines, the same criteria apply as for Family 7.2 (half loops with rolls). For rolls at the apex of the half or three-quarter loop segments, the criteria for Family 7.4.1 - 7.4.2 (round loops) apply.

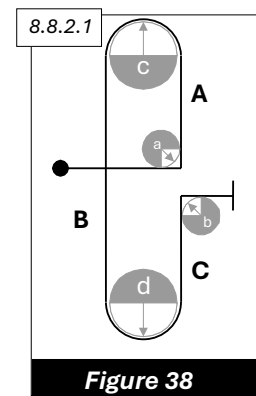


**Figure 37**

**B.9.21. Family 8.8 – Double Humpties**

B.9.21.1 These comprise of three vertical lines and two 180° looping segments (Figure 38).

B.9.21.2 In view of the markedly different speeds possible during the looping segments, none of the radii (a, b, c, d) have to be equal (but each must be internally constant). There is no requirement either for any relation between the vertical line lengths. All other criteria for humpty-bumps apply (see B.9.17).



**Figure 38**

**B.9.22. Family 9 – Rolls and Spins**

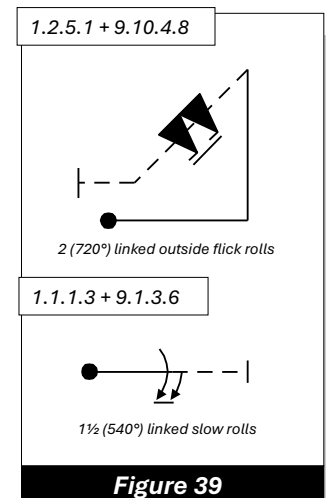
B.9.22.1 Rolls may be performed on horizontal, 45 degree or 90 degree lines; on complete loops; between part-loops; between part-loops and lines; and following spin elements.

B.9.22.2 They may be 1/4, 1/2, 3/4 or a full 360 degrees in their rotation, up to two consecutive full rolls. Additionally, aileron rolls may be flown in combination with turns and loops.

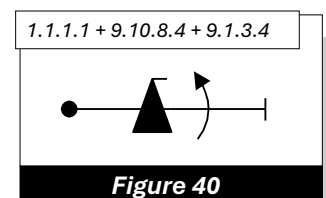
In all cases, the same criteria apply: the rate of roll must be constant throughout the roll(s). The aircraft should continue to project, during the rolling portion, the prescribed plane and direction of flight.

B.9.22.3 Multiple rolls may be linked, unlinked, or opposite.

- a) When rolls are in continuous rotation, the tips of the symbols are linked by a small line. When flying linked rolls there is no pause between them. (Figure 39)
- b) Unlinked rolls must be of different types; the two types being defined as follows:
  - i) Aileron rolls and hesitation rolls
  - ii) Flick rolls (positive and negative)
  - iii) With unlinked rolls, no line links the symbols, though their tips are drawn pointing in the same direction (i.e., on the same side of the line). They must have a brief but perceptible pause between them, and they are to be flown in the same direction of rotation. (Figure 40)

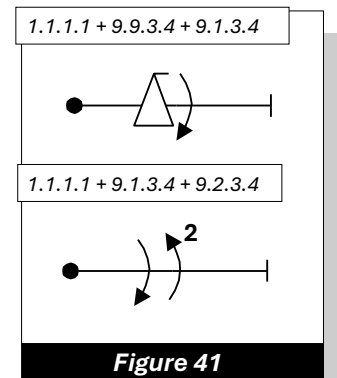


**Figure 39**



**Figure 40**

- c) Opposite rolls may be either of the same or different type. In opposite rolls, the tips of the symbols are drawn on opposite sides of the line, indicating they are to be flown in opposite directions of rotation. The pilot may elect to fly the first roll in either direction, but the second roll must be opposite direction to the first. Opposite rolls, including those in rolling turns, should be flown as one continuous manoeuvre - the brief check between opposite rotations should be minimal. (Figure 41) If the two rolls are of the same type, they must be flown in opposite directions if they are not linked.
- d) Either aileron or flick rolls may follow spin elements (Family 9.11 or 9.12). When a spin and a roll are combined on the same vertical down line they will always be unlinked; may be flown in either the same or opposite direction, as shown by the position of the tips of the symbols on the Form B or C; and the combination may not exceed two rotational elements. (For example, it would be illegal to combine two opposite direction aileron rolls with a spin element.)



### **B.9.23. Family 9.1 – Aileron Rolls**

- B.9.23.1 The penalty for varying the rate of roll is one (1) point per variation. Any stoppage in the aileron roll that could result in its being considered a hesitation roll, would hard zero (HZ) the figure. The finish of the roll must be as crisp and precise as possible. Coming to a slow finish in fact represents a change in the rate of roll and should be penalized accordingly.
- B.9.23.2 The wings must stop precisely after the desired degree of rotation and not go past the stop point and then return. This is referred to as "bumping the point". A deduction of 0.5 point to one (1) point is awarded depending on the severity of the "bump"

### **B.9.24. Family 9.2 - 9.8 – Hesitation Rolls**

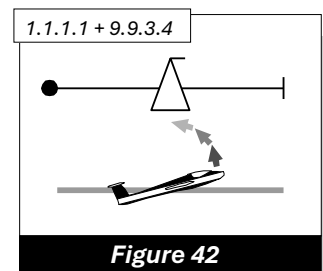
- B.9.24.1 For hesitation rolls, the second digit in the catalogue number indicates the number of points: Family 9.2 is 2-point rolls; Family 9.4 is 4-point rolls; and Family 9.8 is 8-point rolls.
- B.9.24.2 These rolls are judged on the same criteria as the slow roll, only the aircraft stops rotation during the roll for a pre-stated number of times, i.e., 2, 4 or 8, at regular intervals. The rate of the roll and the rhythm of the hesitations must be constant throughout with the aircraft projecting the pre-stated plane and direction of flight.
- B.9.24.3 The pauses will be of identical duration. Each pause of a hesitation roll must be clearly recognizable in every case, but it is especially important that in poor visibility or at high height, the competitor pauses long enough to make them recognizable to the Judges. If a pause is not recognizable to a judge, the figure is marked a Hard Zero (HZ).
- B.9.24.4 Angular errors at each pause are downgraded by comparison to the expected attitude. For instance, an angular error at an intermediate hesitation stop, that is corrected in the next stop, must be downgraded only once; an angular roll attitude error at an intermediate hesitation stop, followed by the prescribed degrees of rotation (45, 90 or 180 degrees), hence not corrected, must be downgraded twice.
- B.9.24.5 "Bumping the point" will be downgraded by 0.5 point to one (1) point depending on the severity of the "bump" for each occurrence.

**B.9.24.6 Family 9.9 – Positive Flick Rolls**

B.9.24.7 Flick rolls represent one of the greatest challenges to judges. This is largely due to two factors: (1) the "flicking" characteristics of different types of gliders vary because of differences in wing section, wingspan and wing planform; and (2), in properly executed flick rolls changes of attitude occur very quickly. Judges must watch particularly carefully to determine the exact order in which events occur, especially at the beginning of the flick.

B.9.24.8 The judge must see two things to determine that a flick roll has been correctly initiated: a) the aircraft must display a rapid and clearly visible change of pitch attitude to put the wing close to the stall, and b) autorotation must be initiated by use of the rudder. Note that when a flick roll is initiated the angle-of-attack may be at or close to zero (e.g. in vertical and 45 degree lines) or significantly positive or negative if a looping figure is being flown; the pitch change to achieve critical angle-of-attack may thus be less in some circumstances and cannot be fixed. However, if the required pitch change and/or actual autorotation are not clearly seen, the mark must be downgraded by four (4) points.

B.9.24.9 At the start of a positive flick roll, the pitch attitude must change in the 'nose up' sense, from the pilot's perspective, clearly and unambiguously (Figure 42). This puts the aircraft's wings near the critical angle-of-attack and can best be seen by carefully watching either the nose or tail of the glider. If the fuselage pitches in the wrong direction, a hard zero (HZ) is given. When, or shortly after, the fuselage pitches the glider must be seen to yaw, initiating a stall of one wing and the rapid onset of autorotation. If the judge observes any movement about the roll axis before the autorotation starts, the figure must be downgraded one (1) point per five (5) degrees of roll. If the judge considers that a proper flick has not been initiated, the mark must be downgraded by four (4) points.

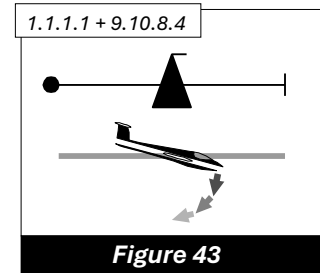


B.9.24.10 Throughout the flick, the roll must be driven primarily by the rudder and autorotation must be seen to continue. This can best be confirmed by the observed conical motion of the fuselage longitudinal axis, with the most obvious displacement at the tail, which is furthest from the C of G. This should not be confused with the spiral motion of a tight barrel roll, wherein the centre of gravity of the glider more noticeably follows a spiral flight path. The rate of rotation and the angle, relative to the flight path, of the conical fuselage rotation may vary between glider types, but the rate of rotation is always considerably faster than when rolled by ailerons. This is an essential clue for the judge to determine that the glider has indeed been flicked. For all aircraft types, the criteria for stopping the flick roll are the same: autorotation must stop as quickly as it started, after the desired extent of roll, followed immediately by the adoption of the attitude that conforms to the requirements of the underlying figure. Downgrades for minor errors in the extent of rotation or the following flight path or attitude are penalised at the normal rate of 1 point per 5 degrees.

B.9.24.11 Flick rolls must be observed very carefully to ensure that the rotation is driven throughout by the asymmetry in yaw induced by continual rudder application and that the competitor is not "aileroning" the aircraft around its longitudinal axis without the conical fuselage motion. The movement of the aircraft's nose departing the flight path prior to autorotation is a good clue to the proper initiation of a flick roll and the continued conical motion of the tail is indicative that autorotation is continuing. When a glider does not stall and autorotation is not achieved, it will follow a spiral flight path similar to a high-rate barrel roll. As always, the competitor is given the benefit of the doubt, but if a judge is certain that a proper flick roll has not been initiated, a HZ is given. Another common error is for the aircraft initially to autorotate, but to not stay in autorotation until the end of the figure. In this case, a deduction of one (1) point for each five (5) degrees of rotation remaining when the autorotation stops must be made. If autorotation ends with more than 45 degrees of rotation remaining, even if the roll is completed with aileron, the flick roll is awarded a numerical zero (0.0).

**B.9.25. Family 9.10 – Negative Flick Rolls**

B.9.25.1 For negative flick rolls, all criteria stated for positive flick rolls apply except that the aircraft is in a negative rather than positive angle-of-attack during autorotation. Therefore, in a negative flick roll the nose and tail of the aircraft must initially move in the 'nose down' sense, from the pilot's perspective, as the angle of attack is changed (Figure 43). This direction of motion must be observed very carefully, since it is the defining characteristic that differentiates a negative flick roll from a positive flick roll. As with positive flick rolls, if the nose does not move in the correct direction, it is not a negative flick roll and the figure must be awarded a hard zero (HZ). In other respects, relating to the characteristics of the rotation and errors to be observed, the criteria are the same as for positive flicks.

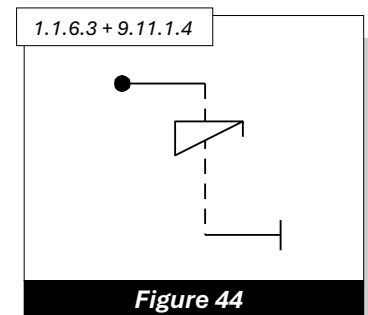


B.9.25.2 Judges should be aware, however, that nearly all aerobatic gliders have cambered wing sections and down elevator authority is more limited than up. Therefore, the negative "flicking" characteristics may be quite different from positive flicks. In general, gliders appear to be more "reluctant" to flick inverted and negative flick rolls may not look as "crisp" as positive ones. Again, the competitor should be given the benefit of the doubt, and the judge should also use the rate of rotation as a clue that the glider has indeed been flicked.

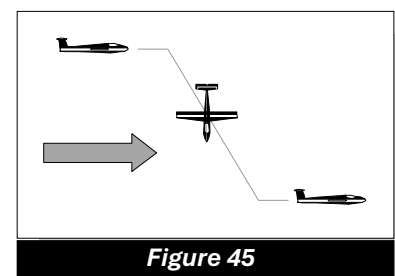
**B.9.26. Family 9.11 and 9.12 – Spins**

B.9.26.1 Spin elements may be combined with any Family 1 or Family 8 figure which begins on a vertical down line. Rolls may follow a spin on the same line.

B.9.26.2 All spins start from horizontal flight. In order to spin, the aircraft must be completely stalled on a clearly visible horizontal line near its minimum airspeed. In a correct spin entry, the nose of the glider drops and autorotation starts simultaneously around the longitudinal and vertical axes. If autorotation around the vertical axis is visibly delayed in relation to the roll around the longitudinal axis, entry airspeed was too high, the glider was "flicked" into the spin and the figure must be marked Hard Zero (HZ).



B.9.26.3 During spin entry and in the spin, the flight path is affected by wind. When the spin is entered with a tailwind, the flight path may suggest that the spin entry was "forced". This change in appearance is not a marking criterion. (Fig. 45)



B.9.26.4 After completion of the prescribed number of turns, the aircraft must stop rotating precisely on the pre-stated heading, then a 90 degree down, wings-level attitude must be seen. Marking criteria for the basic figure being flown then resumes. If a roll follows a spin, there should be a brief, but perceptible pause (similar to unlinked rolls) between the spin and the roll. Because there is no vertical line before the spin, there is no criterion to centre either a spin element alone or a spin-roll combination on the vertical down line.

B.9.26.5 Be alert for early stopping of the stalled autorotation followed by "aileroning" to the pre-stated heading. In this case, a deduction of one (1) point for every five (5) degrees of "aileroning" must be applied. For example, in a one-turn spin the autorotation is observed to stop after 345 degrees of rotation and the ailerons are used to complete the rotation. The highest score this spin could receive is a 7.0. The same obviously applies for over-rotating and correcting back to the prescribed heading.



- B.9.26.6 No account is to be taken of the pitch attitude of the aircraft during autorotation, as some aircraft spin in a nearly vertical attitude while others spin quite flat in conventional spins. Speed of rotation is also not a judging criterion. If the aircraft never stalls, it is apparent that it cannot spin, and a downgrade by four (4) points must be given. You will see "simulated" spins where barrel rolls or flick rolls are offered as spin entries. In both cases, the flight path will not be downward. In all of these cases, the figure will be downgraded by four (4) points.
- B.9.26.7 In all spins the marking criteria are:
- A clean breaking stall in horizontal flight.
  - Fully stalled autorotation.
  - Stopping on pre-stated heading.
  - 90 degrees down, wings-level attitude after stopping on heading.

## **B.10. Positioning**

(See paragraph 4.1.5).

- B.10.1.1 Positioning is marked by the individual judges.
- B.10.1.2 Positioning refers to the placement of the figures in relation to the main and secondary axes of the performance zone. Additionally, positioning relates to the placement of each figure at its optimum distance from the judges, taking into account the height of the glider and the nature of the figure being flown. Lastly, positioning also refers to the symmetrical placement of the entire sequence in relation to the lateral (secondary) axis of the performance zone.

### **B.10.2. Optimal Placement of Figures**

- B.10.2.1 Accurate flying is best assessed when the judges' sight line is neither too high nor too low above the horizon. On the other hand, a glider continuously loses height whilst flying an aerobatic sequence. In practise this means for the pilot, in order to place his figures optimally that he should not fly too close to the judges whilst high up and not too far away from the judges toward the end of the sequence at lower altitude.
- B.10.2.2 This must also consider the character of the figure flown. For example:
- A loop or 45 degree line cannot be judged accurately when flown too close to the judges.
  - A rolling turn at low altitude, flown away from the judges, is much harder to assess than flown towards the judges.

### **B.10.3. Sequence Symmetry**

- B.10.3.1 A sequence should be flown so that it is symmetrically placed in relation to the lateral (secondary) axis of the performance zone. Particularly under wind influence, the pilot must try to balance his sequence, so it remains centred on the lateral axis.



**C. APPENDIX C:**  
**RULES FOR THE USE OF ELECTRONIC HEIGHT MEASURING DEVICES (HMDs)**

**C.1. Types of HMDs**

C.1.1.1 Height Measurement devices to be used in competition, have to be approved by CIVA by the approval process described in C.6 Functions of HMDs

**C.2. Types of HMDs**

C.2.1.1 An onboard transmitter sends signals to the ground receiving equipment (at the Chief Judge position) when the glider descends below the upper or lower height limits or the disqualification height. The ground equipment emits an audio signal ("beep") and records the height of the glider whenever signals from one of the onboard transmitters are received.

Discrete height limits can be selected whenever this becomes necessary due to terrain or other reasons.

C.2.1.2 The HMD box in the glider cockpit gives the following audio signals to the pilot:

- a) Functional Checks at 100/200 m during tow (one "beep" each).
- b) Continuous signal ("beep-beep-beep") as long as the glider flies above the upper height limit.
- c) Descent below the upper height limit is indicated by the stop of the continuous signal.
- d) f) Descending below 200 m until reaching 100 m: Continuous signal ("beep-beep-beep").  
If the glider climbs back above the respective height, the signal will be repeated every time it descends below that height again.

**C.3. Technical Characteristics**

C.3.1.1 The onboard transmitter will always send its signals according to the pre-programmed height limits. Small tolerances are preset when programming the transmitters. This ensures that the signal for the upper height limit will be transmitted at an actual height slightly above the limit, whilst the signals for the lower limit and the disqualification height are transmitted slightly below the exact height. The Chief Judge decides which tolerances will be set when programming the airborne transmitters.

The guaranteed overall tolerance of the HMD systems is considerably smaller than the tolerances of the conventional altimeters used in gliders. Pilots must further understand that unlike mechanical altimeters, the electronic pressure sensor in the HMD has no hysteresis, i.e. it is not influenced by rate of descent or climb. This means that whilst the mechanical altimeter displays a significant lag during rapid changes of altitude (always indicating low in a climb and high in a descent), the HMD will transmit its signal exactly at the pre-set height. Under certain conditions, however, there may be a short delay of typically 2-3 sec. before the ground equipment receives the signal due to the technical limitations of the data link system used.

The main signal to transfer is the information if the HMD is beeping or not. The analysis of an actual height infringement lies in the HMD in the aircraft. The ground station is for recording and displaying purposes only. Additional data to transfer by radio is optional and welcome. Flight data shall be logged internally to provide for analysis in case of radio or ground station malfunction.

**C.4. Operating the HMD**

C.4.1.1 Whenever an HMD is in use, it will be the primary reference for the Chief Judge to verify compliance with height limits and for decisions on penalties or disqualifications due to height infringements. HMD audio signals are recorded together with the official video.

C.4.1.2 The main signal to transfer is the information if the HMD is beeping or not. The analysis of an actual height infringement lies in the HMD in the aircraft. The ground station is for recording and displaying purpose only.



Additional data to transfer by radio is optional and welcome. Flight data shall be logged internally to provide for analysis in case of radio or ground station malfunction.

- C.4.1.3 Calibration, installation, setting up, checking, and removal of the HMD onboard transmitters will be performed by persons specifically designated for this duty.
- C.4.1.4 Towing height with HMD is always at least 50 m higher to ensure proper functioning of the device.

**C.5. Malfunction or Failure of the HMD**

- C.5.1.1 Whenever a competitor notices or assumes a malfunction of the HMD (e.g. the audio signal does not stop below 1200 m), they may return for landing without starting the programme. After starting the programme, there is no justification for breaking off due to an assumed malfunction of the HMD.
- C.5.1.2 A failure of the link between the HMD and the official video recording equipment has no influence on the validity of the HMD measurements, as long as the normal functions of the HMD, as described above, are not degraded.
- C.5.1.3 If the HMD system becomes unserviceable during the contest, procedures for towing and determining infringements of height limits for subsequent flights will be in accordance with the rules laid down in paragraph 4.4.1

**C.6. Approval of HMDs**

To use an HMD during competition, the approval shall be conducted before beginning of competition flights. For approval the HMD has to show compliance with:

- C.6.1.1 Height infringement information transfer is mandatory. This is to be considered as 'HMD in cockpit is now beeping'. The infringement information should be sent about 10 times per second during infringement situation to fit in with bandwidth limitations and get data to the ground station within time limits of C.3.1.1. In height situations away from infringement a transfer rate of once per second is adequate to save band width.
- C.6.1.2 Radio range should be at least 3 km within line of sight. Compliance can be shown by test flights (e.g. by tow planes) at upper height limit at 2500m radius around ground station.
- C.6.1.3 Altitude test and infringement warning test can be shown by HMD tests in simple vacuum chambers, e.g. an exsiccator with a calibrated altimeter connected. No more than 3 HMDs shall be used in one test to avoid bandwidth collision. If no calibrated altimeter is available, an incline tube manometer can be used. A deviation bandwidth of 10m is considered worthy. The water column is:

| <b>Altitude [m]</b> | <b>Water Column [mm]</b> |
|---------------------|--------------------------|
| 0                   | 0                        |
| 100                 | 117                      |
| 200                 | 234                      |
| 750                 | 876                      |
| 800                 | 934                      |
| 1200                | 1401                     |
| 1250                | 1459                     |



- C.6.1.4 Ground station operation: The ground station shall be able to easily put the supervising focus to one HMD transmitter and to validate the correct selection. Transfer and display of altitude and position of device in focus is considered compliant.
- C.6.1.5 Fixture The glider shall provide a fixture for quick mount and release of HMD. The proposed dimensions to reuse older HMD fixtures is a footprint of maximum 104mmx200mm. Deviations have to be announced for contests with HMDs with different dimensions. The fixture bracket can be released to service with use of an EASA Standard Change. Suitable standard changes are CS-SC051d, CS-SC058a, CS-SC061a, CS-SC062a



**RECORD OF AMENDMENTS**

| <b>Version Number</b> | <b>Date Issued</b> |
|-----------------------|--------------------|
| 2006-1                | 1 February 2006    |
| 2007-1                | 1 January 2007     |
| 2008-1                | 1 March 2008       |
| 2008-2                | 1 May 2008         |
| 2009-1                | 1 January 2009     |
| 2010-1                | 1 February 2010    |
| 2011-1                | 1 February 2011    |
| 2012-1                | 15 February 2012   |
| 2013-1                | 15 February 2013   |
| 2014-1                | 1 January 2014     |
| 2015-1                | 24 Mar 2015        |
| 2015-2                | 17 May 2015        |
| 2015-3                | 28 May 2015        |
| 2016-1                | 1 January 2016     |
| 2016-2                | 1 April 2016       |
| 2017-1                | 1 January 2017     |
| 2018-1                | 1 January 2018     |
| 2019-1                | 1 January 2019     |
| 2020-1                | 1 January 2020     |
| 2021-1                | 1 January 2021     |
| 2022-1                | 1 January 2022     |
| 2023-1                | 1 March 2023       |
| 2024-1                | 1 February 2024    |
| 2025-1                | 1 February 2025    |
| 2026-2                | 15 March 2026      |