

**FÉDÉRATION AÉRONAUTIQUE INTERNATIONALE
AEROBATICS COMMISSION (CIVA)**

**REGULATIONS FOR THE CONDUCT
OF INTERNATIONAL AEROBATIC EVENTS**



**PART TWO
EVENTS FOR GLIDER AIRCRAFT**

2003

**Version 2003-1
Amended 14.2.03**

Secretariat of FAI:
Avenue Mon-Repos 24, CH-1005 Lausanne, Switzerland
Tel: +41 21 345 1070 - Fax: +41 21 345 1077 - E-mail: sec@faiorg
Web: www.faiorg

Copyright 2001

All rights reserved. Copyright in this document is owned by the Fédération Aéronautique Internationale (FAI). Any person acting on behalf of the FAI or one of its Members is hereby authorized to copy, print, and distribute this document, subject to the following conditions:

- 1. The document may be used for information only and may not be exploited for commercial purposes.**
- 2. Any copy of this document or portion thereof must include this copyright notice.**

RIGHTS TO FAI INTERNATIONAL SPORTING EVENTS

All international sporting events organised wholly or partly under the rules of the Fédération Aéronautique Internationale (FAI) Sporting Code are termed *FAI International Sporting Events*. Under the FAI Statutes, FAI owns and controls all rights relating to FAI International Sporting Events. FAI Members shall, within their national territories, enforce FAI ownership of FAI International Sporting Events and require them to be registered in the FAI Sporting Calendar.

Permission and authority to exploit any rights to any commercial activity at such events, including but not limited to advertising at or for such events, use of the event name or logo for merchandising purposes and use of any sound and/or image, whether recorded electronically or otherwise or transmitted in real time, must be sought by way of prior agreement with FAI. This includes specifically all rights to the use of any material, electronic or other, that forms part of any method or system for judging, scoring, performance evaluation or information utilised in any FAI International Sporting Event.

Each FAI Air Sport Commission is authorised to negotiate prior agreements on behalf of FAI with FAI Members or other entities as appropriate, of the transfer of all or parts of the rights to any FAI International Sporting Event (except World Air Games events) which is organised wholly or partly under the Sporting Code section for which that Commission is responsible. Any such transfer of rights shall be by “Organiser Agreement” as specified in the current FAI Bylaws Chapter 1, para 1.2 “Rules for Transfer of Rights to FAI International Sporting Events”.

Any person or legal entity which accepts the responsibility for organising an FAI Sporting Event, whether or not by written agreement, in doing so also accepts the proprietary rights of FAI as stated above. Where no formal transfer of rights has been established, FAI retains all rights to the event. Regardless of any agreement or transfer of rights, FAI shall have, free of charge for its own archival and/or promotional use, full access to any sound and/or visual images of any FAI Sporting Event, and always reserves itself the right to have any and all parts of any event recorded, filmed and/or photographed for such use, without charge.



TABLE OF CONTENTS

1. REGULATIONS FOR THE ORGANISATION OF WORLD AND CONTINENTAL AEROBATIC CHAMPIONSHIPS AND INTERNATIONAL AEROBATIC COMPETITIONS

1.1. **Administrative Arrangements** 3

1.1.1. Entry Fees 3

1.1.2. Accommodation, Food, and Medical Services 3

1.1.3. Towing Aircraft and Crews..... 4

1.1.4. Technical Services 4

1.1.5. Interpreters 4

1.1.6. Briefings..... 4

1.1.7. Familiarisation Flights 5

1.1.8. Sequence of Flights (drawing of lots) 5

1.2. **Programmes for World and Continental Championships** 6

1.2.1. Competition flights 6

1.2.2. Known Compulsory 1 (Programme 1)..... 6

1.2.3. Unknown Compulsory 1,2, and 3 (Programmes 2, 4, and 6)..... 7

1.2.4. Free Programme (Programmes 3, 5, and 7) 8

1.2.5. Final Round..... 9

1.3. **International Competitions** 9

1.3.1. Programmes 9

1.3.2. Winners and placings 10

1.4. **Operating Regulations** 10

1.4.1. Radiophones..... 10

1.4.2. Meteorological Conditions..... 10

1.4.3. Competition Flights..... 12

1.4.4. Height Limitations 13

1.4.5. Performance Zone 14

1.4.6. Measures in Case of Mechanical Defects 15

1.4.7. No Radio Procedure 16

1.4.8. Video Recording 16

1.4.9. InFlight Data Recording..... 16

1.5. **Awards** 17

1.5.1. World Championships..... 17

1.5.2. Continental Championships and International Competitions..... 17

2. REGULATIONS FOR THE EVALUATION OF COMPETITION FLIGHTS IN INTERNATIONAL AEROBATIC EVENTS 18

2.1. **Evaluation of the Performance** 18

2.1.1. Judges..... 18

2.1.2. Marks for Figures..... 18

2.1.3. Calculation of Scores 18

2.1.4. Marking of Positioning 19

2.1.5. Versatility (Free Programme) 20

2.1.6. Harmony..... 20



2.2.	Coefficients for the Programmes	21
2.3.	Rules for the Marking of Figures	21
2.4.	The Penalty Point and Devaluation System	22
2.4.1.	Infringements of Height Limits	22
2.4.2.	Infringements of the Performance Zone.....	23
2.4.3.	Programme Interruptions.....	23
2.4.4.	Violation of Training.....	24
2.4.5.	Failure to Appear.....	24
2.4.6.	No Wing Dip at the Beginning or End of a Programme	24
2.4.7.	Flight Regulations and Dangerous Flying.....	24

APPENDICES

1	CRITERIA FOR JUDGING GLIDER AEROBATIC FIGURES	25
2	THE TARASOV-BAUER-LONG-PENTEADO (TBLP) METHOD OF CALCULATING SCORES AND RESULTS.....	47
3	LIST OF FIGURES FOR PROGRAMMES 2, 4, AND 6	53
4	CODE OF PRACTICE FOR THE CHIEF JUDGE AND BOARD OF JUDGES	70
5	THE AEROBATIC PERFORMANCE ZONE	72
6	JUDGES PERFORMANCE FACTORS.....	73
7	WIND LIMITS.....	74
8	RULES FOR THE USE OF THE HHMD	75

	CHECKLIST OF ANNUAL AMENDMENTS	78
--	--------------------------------------	----



1. REGULATIONS FOR THE ORGANISATION OF WORLD AND CONTINENTAL CHAMPIONSHIPS AND INTERNATIONAL AEROBATIC COMPETITIONS

1.1. ADMINISTRATIVE ARRANGEMENTS

1.1.1. Entry Fees

1.1.1.1. World Championships

- a) Every National Aero Club sending a team or a solo pilot to World Championships must pay an entry fee for each participant to the organising Aero Club. Entry fees will be fixed by CIVA on agreement with the organisers.
- b) The organising Aero Club will notify the National Aero Clubs about the date of payment and the receiving agency.
- c) Entry fees will be refunded if the World Aerobatic Championships are cancelled.
- d) Judges, judges assistants, specialists (i.e. for computers), if invited or accepted by the organiser, and three members of the technical commission, selected by CIVA (Sporting Code 1.4.4.), will be free of charges.

1.1.1.2. Continental Championships and International Competitions

- a) Every National Aero Club sending a team or a solo pilot to the event must pay an entry fee for each participant to the organising Aero Club.
- b) Entry fees will be fixed by CIVA on agreement with the organisers.
- c) The organising Aero Club will notify the National Aero Clubs about the date of payment and the receiving agency.
- d) Entry fees will be refunded if the event is cancelled.
- e) The decision on refunding entry fees for other reasons is left to the organisers.
- f) Judges, judges assistants, specialists (i.e. for computers), if invited or accepted by the organiser, and three members of the technical commission, selected by CIVA (Sporting Code 1.4.4.), will be free of charges.

1.1.2. Accommodation, Food and Medical Services

1.1.2.1. During World Championships the organisers will provide adequate accommodation and food for the duration of the event to all members of official teams, solo competitors, officials and other assistants for whom entry fees have been paid, on the understanding that no extra charges will be imposed for those services. In addition, airfield charges and other fees for installations on the airfield will be covered by the entry fees for the persons concerned.

1.1.2.2. The organisers can also decide if the costs for accommodation and food be excluded from the entry fees. In any event, they will give assistance with room reservation and will ensure that sufficient food supply will be available at or near the airfield.

1.1.2.3. The organisers will be responsible for adequate medical services being available to all official participants.



1.1.3. Towing Aircraft and Crews

- 1.1.3.1. The organisers must make available towing aircraft and crews who are duly qualified and trained for this purpose.
- 1.1.3.2. The availability of at least two towing aircraft in service and one standby aircraft must be guaranteed. The performance of towing aircraft must meet the requirements of take-off sequence as shown under 1.4.3.1.
- 1.1.3.3. Costs for competition and training flights may be charged additionally.

1.1.4. Technical Services

- 1.1.4.1. The organiser will provide technical assistance and hangar space for the competing aircraft, if required.

1.1.5. Interpreters

- 1.1.5.1. Interpreters for the official language(s) of the contest, working together with the International Jury and the Board of Judges, will be provided by the organisers. The official language(s) must be stated in the Local Regulations.

1.1.6. Briefing

- 1.1.6.1. Prior to beginning of a contest there will be a briefing by the organisers for Chief Delegates or Team Managers, members of the International Jury and the Judges on flight conditions, the contest programmes and any other problems which might arise over the interpretation of the rules.

1.1.6.2.

a) For familiarisation with and a standardised interpretation of the judging rules, the Chief Judge will hold seminars with the Judges and Team Managers or other Team Representatives and carry out at least one judging test, for which a non-competing pilot shall be available. However, this judging test can also be conducted during the official training flights, in so far as the pilots give their intended flight programmes beforehand to the starter.

b) At the same time a test of the computer scoring system can be made.

c) Throughout the duration of the contest the Chief Judge will hold routine evaluation meetings with the Judges.

d) Before the seminar starts, the Chief Judge must conduct a written examination which will test the judges' knowledge of the rules, judging criteria, and their ability to read the diagrams.

e) If before the first competition flight a judge is not at standard level (as a result of the examination or in the judging of the familiarisation flights), he or she can be removed from the Board of Judges by the Chief Judge with the agreement of the International Jury. It is recommended that he/she serve as an assistant judge in order to remain on the "G" list of judges.

- 1.1.6.3. Prior to beginning of competition flights on each competition day, a briefing will be held for competitors, Officials, Judges, and the International Jury on organisational matters, concerning the competition day, meteorological conditions, etc. The briefing should last not longer than 30 minutes.



1.1.7. Familiarisation Flights

- 1.1.7.1. At World and Continental Championships each competitor will be allowed to make at least one flight over the marked performance zone for familiarisation with the local conditions. The upper altitude limit is 1,200 m (over datum). Familiarisation flights are subject to the same safety regulations as contest flights, and they must be made according to the organiser's schedule. No other practice is allowed during the competition.
- 1.1.7.2. During the time of the official familiarisation flights, no other training is allowed. The pilot shall immediately land upon completion of the familiarisation flight, in any case, upon reaching 200 m altitude.
- 1.1.7.3. No training flights are allowed during the competition. In case of violations there will be penalty points (see 2.4.4) or disqualifications (see 1.2.3.8).
- 1.1.7.4. Familiarisation flights can be shortened or split as well if insufficient weather conditions apply. If weather conditions permit full towing altitude for familiarisation flights, those pilots who had only a flight with reduced towing height, can perform the rest of their programme in an additional flight (see also 1.4.2).
- 1.1.7.5. It is possible for participants to fly stated manoeuvres for purposes of media coverage with the agreement of the Chief Judge, the International Jury and a two-thirds majority of the Chief Delegates.
- 1.1.7.6. For International Competitions the same procedures apply.

1.1.8. Sequence of Flights (Drawing of Lots)

- 1.1.8.1.
 - a) For the entire contest (except Programme 7) the sequence of flights of Championships and International Competitions will be determined by drawings of lots, to be arranged by the Contest Director or his assistant, in the presence of a representative of the International Jury. Each competitor (or his/her representative) will draw his/her own lot. If available, the drawing of lots can be made by a CIVA approved random program under the supervision of the International Jury.
 - b) For Programmes 4, 5, and 6 the competitors will be divided into 3 equal groups. The groups will be based on the provisional overall results after the previous programmes. The order of flight in each group will be determined by lot: the order of flight for the Unknown will be group I, II, and III and for the Free Programme III, II, and I; nevertheless, for the last expected programme in case of time shortage, the order of flight can be I, II, and III. Group III would fly only if the time left permits it. The programme flown only by groups I and II will count for the individual results and not for the team results.
 - c) The sequence of flights for the final round (1.2.1.1, programme 7) will be in reverse order of the overall ranking after programme 6 (also provisional ranking is allowed, if the ranking is not yet official).
- 1.1.8.2. The sequence determined by lot may be altered by the International Jury if special circumstances require (e.g. use of the same glider by different competitors). The first three places must not be altered for the Unknown Compulsory Programmes. After any drawing of lots, the first competing pilot should have an allowance of one hour between drawing of lots and taking off.



1.1.8.3. The first two flights of each competing day and each programme will be by non-competing pilots, if available.

1.2. PROGRAMMES FOR WORLD AND CONTINENTAL CHAMPIONSHIPS

1.2.1. Competition Flights

(Sporting Code, Section 6, 1.3.1.1 "G")

1.2.1.1. The Championship includes three competition rounds:

Round	Flight Programme(s)
Demonstration	Known Compulsory (Programme 1) Unknown Compulsory 1 (Programme 2) Free Programme 1 (Programme 3)
Elimination	Unknown Compulsory 2 (Programme 4) Free Programme 2 (Programme 5) Unknown Compulsory 3 (Programme 6)
Final	Free Programme 3 (Programme 7)

The Free Programme for each round will be the same.

1.2.1.2. Performing the programmes in the sequence from 1 to 7 is mandatory.

1.2.2. Known Compulsory (Programme 1)

1.2.2.1. The Known Compulsory Programme will be composed of figures and combinations of figures in normal and inverted flight performed consecutively and continuously, observing the prescribed sequence of figures.

1.2.2.2.

a) The programmes must be such as to enable competitors to fly all figures safely in the glider available to them, provided the glider meets the requirements of full aerobatic certification. It must be guaranteed that the programme can be flown safely within the available height limitations (see 1.4.4).

b) Performance data and flight characteristics of the expected gliders have to be considered.

c) The FAI Catalogue of Glider Aerobatic Figures (GAF) will be the reference source for figures to be flown in all competition rounds.

1.2.2.3. Programme 1 of World Championships will be selected by CIVA at least six months prior to the next World Championships and be published accordingly.

1.2.3. Unknown Compulsory 1, 2, and 3 (Programmes 2, 4 and 6)

1.2.3.1. Unknown Compulsory Programme 1, 2 and 3 must consist of a total of 21 figures or figure combinations, selected by the Chief Delegates or Team Managers (at the discretion of the National



Aero Club concerned) from Appendix 3. 3 figures maximum can be chosen in each of the families 2, 5, 6, 9.9, 9.10, and 9.11/12. No figure or combination of figures may be selected with a K higher than 35. In composing the programmes they must not be replaced by other figures. Two or more additional figures will be selected by the International Jury.

The programmes must be such as to enable competitors to fly all figures safely with the glider available to them.

- 1.2.3.2. The list of figures in Appendix 3 for Programmes 2, 4, and 6 (Unknown Compulsory 1, 2, and 3) will be approved by CIVA according to the GAF for glider aerobatics. The technical standards of gliders available (full aerobatic certification) must be considered in compiling the list. This list should be re-approved at each CIVA meeting prior to a World Championship, if necessary.
- 1.2.3.3. If more than 21 teams apply, 21 representatives will be determined by secret drawing of lots each to select a figure used in composing Programmes 2, 4, and 6. If there are less than 21 teams their representatives will first select one figure. Then the teams will draw lots a second time and third time if necessary in order to determine which teams will choose a second and eventually third figure until a total of 21 is reached. In the case of teams who select two (or three) figures, one must be a reversing figure and the sum of coefficients of the two figures must not exceed 55 and if they choose 3 figures the sum of the coefficient of the figures cannot be more than 70. All additional figures will be selected by the International Jury.
- 1.2.3.4. The same catalogue number cannot be chosen twice (except for rolls) including in combinations of figures and except the figures selected by the International Jury. The sequence of selecting the figures by the representatives (see 1.2.3.3.) will be fixed by a drawing of lots.
- 1.2.3.5. The sequence of figures for Programmes 2, 4, and 6 will be composed by the International Jury from the proposed figures and the additions of the International Jury. The figures they select shall be solely for the purpose of aiding the composition of the sequence; nevertheless, they may add figures in order to reach the minimum of 175 K if necessary. Figures changing the direction have also to be added. For this purpose and to avoid exceeding the maximum coefficient for the programme, the International Jury is entitled to vary one or more of the proposed figures without changing its basic characteristics. In any event the total of figure coefficients must not exceed 190, nor be less than 175. A tolerance of 3 points infringement is allowed to help the International Jury with the linking of the figures.
- 1.2.3.6. Figures shall be selected, taking into account the performance data and flight characteristics of competing aircraft and the safety of all pilots.
- 1.2.3.7. If the representative of a team or a single competitor is able to show within 30 minutes after issue of a programme that the sequence of figures for Programmes 2, 4, and 6 designed by the International Jury is dangerous, then the International Jury shall design a revised sequence, without changing the figures selected according to 1.2.3.1. After this time (30 minutes) the Unknown Compulsory Programme is considered as approved by the pilots.
- 1.2.3.8. Training for Unknown Compulsory Programmes is not allowed. Competitors violating this regulation will be disqualified (see also 2.4.4).
- 1.2.3.9. The Unknown Compulsory Programme can be flown 12 hours after approval by the pilots (1.2.3.7.).

1.2.4. Free Programme (Programmes 3, 5, and 7)

1.2.4.1.



- a) All three rounds include the same Free Programme. The Free Programme is selected by competitors according to the GAF catalogue. Catalogue numbers may be used only once, except for horizontal lines (sub-family 1.1) and slow rolls (family 9.1). Basic figures may be repeated, however, if they are used in combinations with different rolls.
- b) The final sum of figure coefficients must not exceed the amount of 220 with a maximum of 13 figures. The sum of the normal figure coefficients may be as large as 223, but will be reduced to 220, starting with the highest value, by removing one point from the highest coefficient figure that has not had a point removed. In form "A" the original figure coefficient will be given as well as the reduced value (see also 2.2).
- c) A bonus score will be added to the total score before penalties for each figure less than 13, but not less than 10, which goes to make up the total sequence. Bonus points will be calculated using the percentages in the following table and added to the competitor's final score automatically by the computer scoring programme.

Number of Figures	12	11	10
Bonus Points (%)	1.5	3.5	6.5

1.2.4.2. The beginning of the Free Programmes must be in normal or inverted horizontal flight, but must be finished in normal horizontal flight.

1.2.4.3.

- a) Not later than at the opening briefing of the contest, each competitor must submit three standard CIVA forms for their Free Programme to the Contest Director in order to make sure that the Programme is composed according to the rules. The forms must be completed in readable black writing. If the pilot has not submitted his programme by the opening briefing, he will not be allowed to take part in Free Programme 1 (Programme 3).
- b) Form "A" will show all symbols, catalogue numbers and coefficients.
- c) Form "B" will show the continuous sequence of the programme as it would be flown with the wind blowing from right to left.
- d) Form "C" will show the continuous sequence of the programme as it would be flown with the wind blowing from left to right.
- e) Form "B" and "C" must show clear symbols for the wind direction.
- f) Only normal GAF symbols, catalogue numbers, and coefficients shall be entered. All other writings or notation will be disregarded.

1.2.4.4.

- a) It shall be the duty of the Contest Officials of the organisers to check Form A of each competitor with the symbols on Form B and C, taking the catalogue numbers of catalogue GAF (latest edition) as definitive. Any inaccuracies in the drawing of symbols or in the quoting of coefficients, or the discovery of any cases of repetition of figures will be referred to the competitor's Team Manager so that the Forms may be corrected and resubmitted. The final responsibility for accuracy and conformance of Forms A, B and C lies with the competitor.



Note that the direction of rotation of rolls in basic figures is not prescribed by GAF rules, i.e. direction of rotation of rolls are at the pilot's discretion. The same procedure applies for direction of rotation of stall turns (hammerheads) and normal, as well as inverted, spins.

- b) In order to avoid possible alteration and resubmission of Forms during the contest, National Aero Clubs may submit the competitor's Forms to the organisers for checking not less than one month prior to the beginning of the contest.

1.2.4.5.

- a) After completion of the examination of the Free Programmes by the Contest Officials, all Free Programmes will be made available to all participants in an appropriate manner. Protests can be made up to 6 hours after these Free Programmes become available.
- b) After the beginning of publication of the Free Programmes, changes are only possible in case of an error of a programme. After the end of the protest time no changes are allowed. In case of errors which are found after this moment which are not acceptable (for example too high a sum of coefficients) the programme can be changed by the Chief Judge with the agreement of the International Jury.

1.2.4.6. An error in the drawings, found in the first Free Programme flight (and penalised by the Judges), can be corrected after Programme 2 for Programme 4 and Programme 7 (to avoid penalisation three times for the same error).

1.2.4.7. The organisers will be responsible for reproducing a sufficient number of copies of competitor's programmes to meet the contest requirements. One set of copies of Programme 2 (Form B or C only) are to be provided to each Team prior to the start of this Programme.

1.2.5. Final Round

1.2.5.1. The number of the highest placing (total scores of the first six flights) pilots who will participate in the Final Round will be determined by the International Jury in the name of CIVA (recommended to be between one half and one third).

1.2.5.2. In the case that they do not already qualify, the six pilots who obtain the highest combined score on their first two Free Programmes may fly in the Final Round. (This only affects the determination of the World Class Champion in the Free Programme, according to Sporting Code, Section 6, 1.3.1.2.b.)

1.3. INTERNATIONAL COMPETITIONS

1.3.1. Programmes

1.3.1.1. The same procedure applies as for World Championships.

1.3.2. Winners and Placings

1.3.2.1. Winners, second and third placings in the overall class and team competition will be established.

1.3.2.2. Winners, second and third placings will be honoured by the organisers in an appropriate way.

1.4. OPERATING REGULATIONS

1.4.1. Radiophones



The use of technical devices to convey audible information to the pilot is not permitted during International Aerobatic Contests, except for a radio set with a blocked "Safety Frequency". Radio sets are permitted if they can set the "Safety Frequency" and if they can be sealed so that no other frequency can be used. Any other devices, which are not permitted, will either be removed from the competing aircraft or rendered inoperative and sealed by the Technical Commission. A competitor breaking a seal applied by the Technical Commission or receiving any kind of audible information from a technical device, (other than a safety device) will be liable to disqualification from the contest.

- 1.4.1.1. Radiophones, set to a "Safety Frequency", are only for communication between the competitor and the contest organisation to settle important and urgent competition problems. In addition, they serve urgent flight safety matters. Use of the Safety Frequency may be discontinued at the discretion of the International Jury if problems occur which compromise its security. In that case, radios will be rendered non-operational by the Technical Commission.
- 1.4.1.2. The "Safety Frequency" will be selected by the organisers and given to the competitor together with the competition papers. The "Safety Frequency" will be monitored during all competition flights, and possibly recorded by tape.
- 1.4.1.3. The organisers (the Technical Commission) will be responsible for technically adequate sealing of radios (without penetrating the interior), assuring that no frequency other than the "Safety Frequency" can be used.

1.4.2. Meteorological Conditions

- 1.4.2.1. Flights will be carried out between the hours of sunrise and sunset at the place of competition. If the visibility deteriorates within this time, the International Jury will decide upon the start and finish of the competition flights.
- 1.4.2.2. The following meteorological conditions are needed:
 - a) The performance zone must be free of clouds.
 - b) The flight visibility, determined with reference to ground features from the midpoint of the performance zone at the maximum height of the competition flight just taking place, must be a minimum of 5 km.
 - c) The maximum permissible average wind speed at all heights should remain inside the diagram in Appendix 6.
 - d) The performance zone must be free of precipitation (see also 1.4.2.9).



e) The performance zone must be free of strong turbulence (see 1.4.2.8), although this does not apply to scattered thermals.

1.4.2.3. It is the International Jury's decision if the weather conditions exist according to 1.4.2.2 a, b, c, d, or e. In the case of doubts about sufficient meteorological conditions, or if at least two Team Chiefs inform the International Jury that weather requirements are not met, the following procedures apply:

a) The members of the International Jury should use an aircraft to be made available for this specific purpose and arrange for a weather reconnaissance flight.

b) If competition flights are in progress, in order to establish the actual weather conditions the next pilot of the towing aircraft will get flight orders by the Jury for a weather report containing all of the required data. The towing aircraft will first cross the performance zone at roughly the release altitude. The competitor will be informed by radio about the purpose of this procedure. The glider pilot will not release during this first towing procedure. If the meteorological conditions are sufficient, the glider will be towed a second time through the performance zone. From this moment regulations according to 1.4.4.2 apply. If the towing aircraft pilot considers meteorological conditions not to be sufficient, and if the Jury decides to stop the current flight, the competitor will be informed via the "Safety Frequency", and he must release and land without delay, and without performing any aerobatics.

1.4.2.4. When light winds prevail (i.e. less than 5 m/s) it shall be at the discretion of the International Jury not to change the principal axis, even though wind direction may be more than 45 degrees from the axis, in order to prevent frequent changes during a day.

The Contest Director must provide the competitors, the Chief Judge, the Board of Judges, and the International Jury with hourly information on weather conditions or at shorter intervals if required by meteorological development, on wind speed in the performance zone and wind direction at 700 m height. The weather bulletin with information on wind speed and direction will be published on a Board at the flight line for competitors upon a decision by the Contest Director. The bulletin must include the time of the measurement as well as the publication time. The Team Managers are responsible for passing those data on to their teams.

Under stable weather conditions, adequately meeting the above conditions, hourly information is not required. The International Jury will decide upon the necessity of providing this information. Rules of the air (VFR) of the organising country, including special competition rules, have to be observed.

1.4.2.5. If the wind speed is out of the diagram in Appendix 6, the Flight Director, after consultation with the International Jury, will discontinue competition flights.

Such decision may be taken:

a) If the information in the bulletin from the airfield weather service was obtained by balloon ascent.

b) If there is information available from tow pilots.

c) If the visibility is judged independently by members of the International Jury, the Chief Judge, or the competitors to be below the minima laid down.

1.4.2.6. If one of the weather conditions deteriorates to less than the minima during a run and if the Jury decides on an interruption of the contest flights, the Flight Director must be informed immediately. If a competitor is being towed, he will be informed via the "Safety Frequency" or according to the "No-Radio-Procedure", whereupon he has to land without delay.



- 1.4.2.7. If the height of release of 1200 m (over datum) is not available due to clouds in the performance zone, but if there are at least 750 m available, the International Jury can cancel the last figures of a compulsory programme and have the shortened programme flown or they can split the programme. They proceed as follows:
- a) In case of the Compulsory Programmes the International Jury will decide on the point of the programme splitting.
 - b) If the cloud base within the performance zone sets to below 1200 m (over datum) and if the Jury decides to cut the programme (not permitted for the Free Programme) or to split it, the pilots have to be first advised at a briefing.
 - c) If a programme is cut, marks for the omitted figures will be cancelled for the pilots who have flown under normal weather conditions. If a programme is split, no pilots are allowed to repeat their flight.
 - d) If the cloud base rises to 1200 m (over datum) during a split programme, competitors must fly their full programmes without interruption after the Jury has so instructed and if during the tow normal weather conditions prevail in the performance zone (according to the tow pilot's report).
- 1.4.2.8. The limit for turbulence in the performance zone (see 1.4.2.2) is +2 G (vertical acceleration). The strength of the turbulence will be determined by five consecutive straight penetrations through the performance zone at 200 km/h at different altitudes. The flight must be conducted by a member of the International Jury or a non-competing pilot appointed by the International Jury, as required, at intervals of not less than half an hour. The flight should be made with an aircraft whose wing loading is comparable to that of the lightest competing aircraft. A common G-meter with limit needles is to be used.
- 1.4.2.9.
- a) If in the opinion of a competitor the weather conditions do not comply with competition rules, he or she may not start his or her competition flight and land. If the competition flight is started, a repetition of the flight or parts of the flight due to insufficient meteorological conditions is not possible, except if rain can be proved as the reason for the breaking off of the flight. For the repetition of the flight in such a case, see 1.4.6.8.
 - b) When a pilot encounters rain after release from tow, either before or during the execution of the programme, he may break off his flight and has to land immediately. The competitor must bring evidence, so he must inform the start line by radio or immediately after landing. In the case where rain cannot be confirmed by a tow pilot or contest officials on the ground (member of the International Jury or a member of the Technical Commission) he must show that the aircraft is wet immediately after landing.
- 1.4.3. Competition Flights**
- 1.4.3.1. The competitors will start in the predetermined sequence. The intervals between releasing will be individually decided by the Board of Judges and will be adapted to the appropriate situation, in order to grant quick continuation. In Compulsory Programmes eight minutes and in Free Programmes ten minutes can be taken as a guide.
- 1.4.3.2. The direction of flight for the start of the Compulsory Programmes shall be determined by the International Jury. The International Jury shall also determine the alignment of the principal axis for the Free Programmes, but competitors may choose to start their first figure along either axis in



either direction, provided they show clearly on the drawings of their programmes the direction to be chosen.

- 1.4.3.3. A competitor must begin and end each programme with a distinct rocking of the wing (dipping a wingtip three times with a bank angle of at least 30°) (see 2.4.6). The pilot shall land immediately at the end of a competition flight.
- 1.4.3.4. There will be, if required, a 30-minute break after every two hours of competition flying for the Board of Judges to have a rest.
- 1.4.3.5. The organisers of World and Continental Championships must establish an efficient radio or telephone communication system between the Contest Officials (Contest Director, President of the International Jury, Chief Judge, Flight Director, Chairman of the Technical Commission and all Line Judges) in order to supervise the running of the contest and the contest rules.

1.4.4. Height Limitations

1.4.4.1. The following height limitations have been determined for all contest flights:

- Upper limit: 1200 m (over datum)
- Upper limit: 750 m (over datum) in a split programme
- Lower limit: 200 m (over datum)

In level land the datum will be taken to be the altitude of the airfield. In uneven land the datum will be the highest point found under the performance zone. The altitude will be rounded off to 50 m, for example, a correction of 25 m height difference above the field will be ignored.

1.4.4.2. The cable release height is at the upper height limit. The tow plane must have a barograph. The barograms have to be kept ready for the Jury.

The competitors determine their point where they release. The tow plane will tow in the direction of the principal axis at 1200 m (over datum) with constant velocity through the performance zone. The height and direction will be established one km before entering the performance zone. If the competitor does not release at the end of the performance zone, he will be towed a second time in the same direction. They must release at the end of the second passage at the latest. The tow plane will indicate that requirement by rocking its wings.

For use of the HHMD, see Appendix 7. Whether or not the HHMD will be used will be stated in the Local Regulations.

1.4.4.3. Height Infringements

- a) For an infringement of the lower limit of 200 m (over datum), the competitor will incur a penalty of 70 points for each figure flown entirely or in part below this limit.



b) For an infringement of the security height of 100 m (over datum) the competitor will be disqualified for the current programme.

- 1.4.4.4. If the organisers do not have any electronic positioning instrument or height aiming devices available, infringement of the heights of 200 m and 100 m respectively (over datum) shall be determined by the Board of Judges on a simple majority.

For better judgement of these heights by the Judges, a neutral aircraft pilot will carry out flights at 100 m and 200 m along the principal axis and the front and back boundaries of the performance zone (if necessary before flying starts each day).

- 1.4.4.5. When terrain conditions in the vicinity of the performance zone permit, for checking of the lower height limit, aiming devices can be used, similar to the aiming devices for side boundary control.

The application of these height aiming devices occurs in the same way from Boundary Judges. Only one device per level is necessary.

- 1.4.4.6. Electronic height measuring devices can be used. The electronic height measuring system used, as well as the rules to operate the system, must be approved by CIVA.

- 1.4.4.7. Disqualification (for the current programme) for grave infringements of the lower height limit shall be decided by the Board of Judges.

1.4.5. Performance Zone

- 1.4.5.1. The programme will be flown with reference to the longitudinal and lateral axis marked on the ground. The performance zone will be a clearly and distinctly marked area of 1000 x 1000 m, whose central point will be the intersection of the axis. The performance zone must be situated close to the airfield (runway).

- 1.4.5.2. Marking of positioning and recording of infringements of the performance zone may be carried out either with an electronic positioning instrument or by Judges in accordance with the judging rules. If the electronic instrument becomes inoperable, the International Jury must decide when Judges are to mark positioning and infringements of the performance zone.

At World Championships the organiser will prepare 4 corners of the performance zone with simple aiming devices for the use of the Line Judges in such a case.

- 1.4.5.3. The longitudinal (principal) and the lateral (secondary) axes shall be marked by 7 contrasting marking strips. The size of these markers must be at least 2 x 9 m, with the long side aligned with the direction of the axis. The end of the axis and the 4 corners of the box must be clearly marked. Two arrows will be placed near the central point of the principal axis. They will indicate the specified "into the wind" direction of the principal axis. (see 1.4.3.2 and Appendix 4).

- 1.4.5.4. The colour of the marking strips must be in distinct contrast to the ground and other airfield markings, which should be removed if possible.

- 1.4.5.5. If the wind vector exceed the limits in Appendix 6, the competition will be discontinued. The International Jury will determine any change of the principal axis, as may be necessary and arrange for a rapid shifting of the direction arrows (see 1.4.2.2, 1.4.2.5, and Appendix 4).



1.4.6. Measures in Case of Mechanical Defects

- 1.4.6.1. In the event of a competing glider becoming unserviceable before the start of a flight, the International Jury may, on the recommendation of the Technical Commission, permit the competitor to use another glider or the same glider following the removal of the defect.

In case of the use of a different glider, the participant may conduct test flights, where the reaction of the glider may be tested. The manoeuvres to be flown are to be discussed with the International Jury beforehand. The International Jury will determine the number of test flights, considering the requirements of flight safety.

- 1.4.6.2. In the event of a competitor breaking off his competition flight in case of technical damage which is beyond the pilot's control after take-off, he may be allowed to repeat the flight, provided that evidence of the damage can be furnished to the Technical Commission within 2 hours after landing. For finding the damage only, the following persons will be permitted to work on the glider: the competitor and the mechanic named by the competitor, plus the members of the Technical Commission (except the one belonging to the pilot's Aero Club) and the International Jury. When the cause of the damage has been found, the damage will be repaired by the mechanic of the glider and other experts, as recommended by the Technical Commission.

As the situation requires, a test flight may be conducted after a repair.

- 1.4.6.3. Any damage will be counted as such, provided it is a break or deformation found on parts of the glider without any special devices except magnifying glasses

- 1.4.6.4. The following defects will not be counted:

- a) incorrect adjustment,
- b) technical trouble caused by dirt if attributed to negligence of the competitor or his team,
- c) insufficient or missing safety devices causing a change of settings during the flight,
- d) defect caused by pilot exceeding the flight limits of the aircraft,
- e) In the cases (a) to (d) the competitor will not be permitted to repeat his flight.

- 1.4.6.5. The International Jury must, not later than five hours from the landing of the competitor concerned, decide whether or not a repetition flight will be approved. In the case of doubt on the basis of the statement by the Technical Commission, the International Jury shall decide in favour of the competitor.

- 1.4.6.6. In order to avoid any delay in the progress of the contest, the flight will be repeated at the end of the current programme even if this is prior to the decision of the International Jury. In the case of an illness or of a technical defect, the latest moment a competitor can fly depends on Regulation 2.1.3.4 resp. Sporting Code 2.1.13 G.

- 1.4.6.7. The sequence of repetition flights is determined by the sequence of interruptions of competition flights.



1.4.6.8. A competitor making a repetition flight must re-fly the entire programme. Judging and scoring will be continued from the figure during which the technical problem occurred in the interrupted programme.

1.4.6.9. In the event that a technical problem arises with an aircraft that prevents the continued participation of a significant fraction of the competitors, the International Jury may, after discussion with the Chief Delegates, declare the contest concluded. The nature of the technical problem must be confirmed by the Technical Commission.

1.4.7. No Radio Procedure

1.4.7.1. The tow plane must be in continuous radio contact with the Chief Judge on the "Safety Frequency" or the competition must be terminated.

1.4.7.2. If the competitor has no operating radio on board or does not confirm instructions from the Chief Judge or the Contest Organisers, the following signals from the aircraft pilot to the glider pilot are applicable:

a) No release in the performance zone during the first towing procedure: Significant rudder motion, at least 0.5 km prior to reaching the performance zone.

b) Release followed by landing without delay and without performing aerobatics: Significant wing rocking at least 0.5 km prior to reaching the performance zone.

1.4.7.3. Should the glider pilot wish to confirm these instructions, he will use the same motions, whereupon the aircraft pilot will answer with the corresponding signal.

1.4.8. Video Recording

1.4.8.1. An official video recording shall be made from the Judges' position of every individual competition flight in a World Aerobatic Championship. The official recording shall be available to the International Jury to assist their decision on any protests. The recording shall not be available to competitors or Team Officials at a World Aerobatic Championship, except in the clarification of a protest in conjunction with the International Jury and with their agreement. The official recording shall also be available to the Chief Judge and the Board of Judges to assist their discussion on matters of fact.

1.4.8.2. These video-recordings (tapes) will be given to the Chief Judge after each programme and will be kept in his personal possession until the end of the contest and will only be made available to the International Jury.

1.4.8.3. After the completion of the championships, the recording may be released by the organisers for use in training.

1.4.9. Inflight Data Recording

1.4.9.1. To force such projects to be available for glider aerobatic contests in the future and to test such systems, inflight data recording, electronic positioning instruments, etc. are allowed for use in World Aerobatic Championships and International Competitions, but only in cooperation with and by the agreement and under control of the International Jury, and without any official status. They can be allocated for official use, if they are approved by CIVA. Such systems, which give special information during the flight to the pilot (audible or visual), are not allowed during competition flights, except if they are approved by CIVA.



1.5. Awards

1.5.1. World Championships

- 1.5.1.1. The World Champions in the various programmes will be awarded medals by the organisers and Diplomas by the FAI.
- 1.5.1.2. The second and third placings in each of these programmes will be awarded medals by the organisers and Diplomas by the FAI.
- 1.5.1.3. The Overall World Champion will be awarded the Gold Medal and Diploma of the FAI; the second and third placings will be awarded a Silver and Bronze Medal respectively and Diplomas of the FAI. The fourth through sixth placings will be awarded Diplomas of the FAI.
- 1.5.1.4. The World Team Champion and the second and third placings will each be awarded Team Medals and Diplomas by the FAI. FAI Gold, Silver and Bronze medals will be awarded to the respective Team Managers. The fourth through sixth placings will be awarded Diplomas of the FAI.
- 1.5.1.5. The organisers are recommended to award medals to the second and third placings in the various programmes.
- 1.5.1.6. The organisers are recommended to award Diplomas to the placings after the sixth place in the overall ranking and from fourth to sixth place in the various programmes.
- 1.5.1.7. The organisers are recommended to give awards at World and Continental Championships to the Chief Judge, the Panel of Judges, the Chief of the Scoring Office and all specialists in the computing room.

1.5.2. Continental Championships and International Competitions

- 1.5.2.1. Granting awards in the form of medals and certificates will be left to the organisers.



2. REGULATIONS FOR THE EVALUATION OF COMPETITION FLIGHTS IN INTERNATIONAL AEROBATIC EVENTS

2.1. Evaluation of the Performance

2.1.1. Judges

- 2.1.1.1. Each programme of World and Continental Championships, i.e. Known Compulsories, Free Programmes, and Unknown Compulsories will be marked by the Judges using a standardised system (see 2.3., 2.4. and Appendix 1).

The same rules should apply to International Competitions.

- 2.1.1.2. The marks given by a Judge to a pilot of his/her own country shall be included.

- 2.1.1.3. Where the majority decision of the Panel of Judges is required, in a case of disagreement about the penalisation of the flight of a competitor, the Judge of the same country as the competitor shall abstain from voting. In case the required simple majority could not be rise from a vote within the Board of Judges, the Chief Judge shall have a casting vote.

2.1.2. Marks for Figures

- 2.1.2.1. The Judges will independently mark the quality of each figure and its components using numbers 0 to 10, accurate to 0.5, using the point reduction system for each element of a figure as described under point 2.3 and Appendix 1. The highest possible mark is 10. A mark of 0 will be awarded if the figure is incorrect or missing. The scores will be calculated by multiplying the coefficient (K) for each figure by the mark given to each.

- 2.1.2.2. In marking the quality of the performance of the figures, the Judges will compare the geometry of the figure flown with the prescribed geometry of the ideal figure as stated in the GAF catalogue and further specified in Appendix 1.

a) If the geometry of the figure flown perfectly matches the prescribed geometry, it will be marked "10".

b) Any deviation from the ideal geometry will be downgraded according to the rules stated in section 2.3 and Appendix 1.

- 2.1.2.3. If a judge misses seeing a figure, or any part of a figure such that a grade cannot be given with full confidence, the Judge will give a mark of "Average" or "A" to that figure. The average grade will be calculated by the scoring computer using scores given by judges who graded the figure.

- 2.1.2.4. When both "A's" and "0's" appear for a figure, the "A's" will be temporarily set aside and the zeroes resolved in the standard fashion as if the "A's" did not exist. If the zeroes hold, the "A's" will also be set equal to zero. If the zeroes do not hold, the "A's" will be calculated using the original non-zero scores and those to which the minority zeroes have been raised.

2.1.3. Calculation of Scores

The calculation of scores for a competitor's programme will be as follows:

- 2.1.3.1. The marks given by a Judge are processed according to the C.I.V.A. Regulations, Appendix 2, with the final scores being determined for a programme as a whole. The CIVA-approved software programme must be used and obtained from the President of CIVA.



- 2.1.3.2. It shall be a duty of the Organiser to arrange for the publication of the competition results in accordance with Rule 2.1.3.1. The marking sheets must be made available to the competitors, Chief Delegates, Team Managers, and Contest Officials for information and/or checking before the start of the subsequent programme.
- 2.1.3.3. A copy of the files generated by the CIVA-approved Computer Scoring System must be available to any official or Team Manager upon request. The media used for that copy will be supplied by the requester and has to be compatible with the computer being used by the Contest Organisers. This could include serial or parallel data transfer techniques if diskettes are not available. A fee of \$25.00 will be charged for the copy of all data, except for the data supplied to the International Jury. A complete copy of all the files must be sent to the President of CIVA after the contest is finished and the media used shall be supplied by the Contest Organiser. No fees will apply in that case.
- 2.1.3.4. The raw scores of each pilot, by judge, will be published after that pilot's flight without classification or normalisation of the scores. Penalty points will also be listed. The final scores and classification of the performance of the pilots is to be made after the completion of each programme. These will be available not later than the beginning of the flight programme subsequent to the next.

Example: Programme 1 final scores must be available before the beginning of Programme 3.

2.1.4. Marking of Positioning

- 2.1.4.1. If an electronic tracking instrument is operated, the observance of the performance zone and the positions of the individual figures are recorded by Positioning Judges (see Sporting Code, Section 6, 2.1.4.1 c and 2.1.4.3).
- 2.1.4.2. If the conventional marking of positioning is used the Board of Judges will give the position marking according to the total impression of the balanced use of the performance zone. In addition, they watch the infringement of the 200 m and 100 m (over datum) height levels. The Line Judges only record infringements of the four sides of the performance zone (see 2.4.2.2).

If aiming devices for horizontal lines are used, the checking of the lower limits of the performance zone is subject to Line Judges.
- 2.1.4.3. If the conventional method is used the infringements of the performance zone boundaries (and eventually also the 100 m and 200 m levels) will be observed by four Line Judges assisted by aiming devices, situated at the corners 50 m outside the marked performance zone (see Appendix 4).
- 2.1.4.4. Competitors should try to perform their programmes within the available air space in axial symmetry. It is not required, however, to use up all the available airspace vertically, if the number and altitude requirements of the figures in a particular programme would normally allow completion at an altitude higher than the minimum. The highest marks will be given if the central point of a competition flight is above the intersection of the x/y axes.

As the use of an electronic tracking instrument will provide a higher degree of objectivity, two different scales of the coefficients for the marking of positioning are required:

	Electronic Instrument	Conventional Method
Compulsory Programmes	K = 35	K = 10
Free Programmes	K = 50	K = 20



2.1.5. Versatility (Free Programme)

- 2.1.5.1. At least one figure of each family 2 and 5 through 9 of the GAF catalogue or of their subordinate families must be included in the Free Programme as stated in the following.
- 2.1.5.2. From family 2 (turns) subfamilies 2.3-2.20, a rolling turn or a part of a rolling turn with at least one roll must be included.
- 2.1.5.3. From family 9.11/12 (spins), at least one full rotation must be included.
- 2.1.5.4. From family 9 (rolls or parts of them), the following must be included as an independent figure or in combination with a figure of other families:
- a) a roll at less than 10 seconds (slow roll, at least 1/2 roll),
 - b) a roll at more than 10 seconds (super slow roll, at least 1/2 roll),
 - c) hesitation roll (at least 2 successive elements),
 - d) inside snap roll (at least 1/2 roll),
 - e) outside snap roll (at least 1/2 roll).

2.1.6. Harmony

- 2.1.6.1. A flight is harmonious when the individual figures are clearly separated from one another, follow one another at similar intervals in time and space, and when the exit velocity of one figure agrees with the entrance velocity of the next figure.

No subtraction of the harmony mark is given when a long pause in a compulsory programme is unavoidable due to un-harmonic construction.

When long gliding pauses are unavoidable because of strong winds, no corresponding reductions will be given to the harmony mark.

- 2.1.6.2. The harmony of a programme is disturbed if:
- a) a long interruption between two figures is found, which is not based on the second and third paragraphs of 2.1.6.1.,
 - b) direction changes between figures are made,
 - c) after a mistaken or abandoned figure a direction change of more than 90° is made, unless the correction can be done in a vertical line (e.g. after a failed stall turn / hammerhead),



d) the line between two figures (horizontal, descending, or ascending) is changed in its inclination in order to increase or reduce speed.

2.2. Coefficients for the Programmes

Programmes	1	2, 4, and 6	3, 5, and 7
Total coefficient of figures	max 190K	max 190K	max 220(223)K
Positioning	35/10K	35/10K	50/20K
Harmony	30K	30K	30K

2.3. Rules for the Marking of Figures

2.3.1. In all programmes a competitor will be given a mark of "0" if:

2.3.1.1.

- a) a pre-stated figure has been omitted,
- b) a figure has been flown which deviates from that stated on the score sheet,
- c) a figure was begun behind the scoring Judges,
- d) a figure was not started or finished in the pre-stated direction,

(Sometimes necessary direction or axis change, e.g. inverted flight, can be executed after a mistaken or abandoned figure as long as the minimum necessary flight manoeuvres are executed and are not identified as independent figures or as a programme interruption.)

- e) there is a deviation of more than 45 degrees from the pre-stated axis at the start, finish or within a figure.
- f) in performing a super slow roll: a half roll is shorter than 4.5 seconds; a complete roll is shorter than 9 seconds; and a one and one-half roll is shorter than 13.5 seconds.

However, if after the omission of one or more figure, all subsequent figures are correct and flown in the correct direction, they shall be marked in the normal way.

2.3.1.2. When difficulties occur in interpreting the correct application of the "0" mark, the Chief Judge must call for a discussion on the spot by the International Judges. The official video may be used in these discussions to help determine matters of fact, but not of perception. Such discussions shall not interfere with the subsequent flights. Form A shall be retained until the final decision is made at the next possible break.

2.3.2. A reduction of the mark by one will be given for each 5 degrees of directional deviation from the pre-stated direction at the completion of a figure. For directional deviations of 2.5°, the mark will be reduced by 0.5. The competitor should, prior to the beginning of the following figure, regain the correct heading. If the competitor continues in the wrong direction, rather than correcting his heading, the mark for each of the subsequent figures of the programme will be reduced by one per 5 degrees directional inaccuracy, until the correct direction is re-established.



Example: The competitor has completed a loop at a deviation of 15 degrees to the left from the pre-stated flight direction without correcting the mistake. The pilot continues the following figures in the same direction. The marks will then be reduced by three for each figure, i.e. the competitor cannot be given more than a mark of "7" per figure.

2.3.3. For deviations in the vertical (90°) or ascending/descending 45° lines, the mark will be reduced by one per 5° directional deviation.

2.3.4. Horizontal lines will be judged on flightpath, not the attitude of the glider. Horizontal lines in glider aerobatics may be inclined between zero (0) and ten (10) degrees below the horizon.

The reference for vertical and 45 degree lines is the angle of the zero-lift axis (see Appendix 1, Section C.) relative to the true horizon. On vertical and 45 degree lines, the flightpath is subject to wind influence and must be ignored when judging these lines.

The absolute length of vertical or 45 degree lines is not a marking criterion. It is justified, however, to give lower marks to pilots showing only very short vertical or 45 degree lines. Excessively long vertical or 45 degree lines must not be rewarded with higher marks.

2.3.5. If while in the pre-stated flight plane (vertical, horizontal, 45° inclination) a competitor allows his glider to bank around the longitudinal axis, the mark will be reduced by one for every 5° of difference between the actual and the prescribed plane of flight.

2.3.6. For combinations of figures the marking of the different basic figures will be combined, e.g. in the case of directional deviations (as under 2.3.5), the combined figure will be taken as a unit.

2.3.7. All figures begin and end on horizontal lines. If there is no recognizable horizontal line between two consecutive figures, the marks for both figures must be reduced by one (1) point each.

2.4. The Penalty Point and Devaluation System

2.4.1. Infringements of Height Limits

2.4.1.1. A competitor flying a figure or part of a figure lower than 200 m (over datum) will receive 70 penalty points for this figure.

A competitor flying his programme lower than 100 m (over datum) will be disqualified for this flight (see 1.4.4.3).

2.4.1.2. In the case where the flight is monitored by an electronic means, the Judges will mark all the figures regardless of the altitude. The excursions below 200 m will be determined later and the scores will be corrected accordingly.

2.4.1.3. In the case where the lower height boundary is supervised by using an aiming device, the respective Line Judge will transmit a height infringement to the Chief Judge, which will immediately be passed on to the Judges. If there is a figure flown below the height limit of 200 m at any one position, this figure (possibly also later) will be given a penalty of 70 points.

The end of a figure occurs as soon as the aircraft completes the curved portion of manoeuvre and enters horizontal or gliding flight, or as soon as the aircraft flies through the horizontal line between two figures. In rolls, the end of the rotation along the longitudinal axis is taken to be the end of the figure.



- 2.4.1.4. In the case where the Judges assess the lower boundary, each Judge will note in writing a height infringement on his score sheet, independent of the other Judges; however, he continues to evaluate the figure being flown.
- 2.4.1.5. Infringements of the lower and upper height limits will be estimated by the Judges and will be penalised only if a simple majority has recognised the violation and duly recorded this on their marking sheets. In case the required simple majority could not rise from a vote within the Board of Judges, the Chief Judge shall have a casting vote. Alternatively, the official video may be used to record audible outputs from the HHMD when it is in operation. An infringement of the lower 100 m level must be agreed by at least a two-thirds majority of the Judges. Which figures will be given penalties will be determined by the Chief Judge at the end of a flight or a run.

2.4.2. Infringements of the Performance Zone

- 2.4.2.1. Every excursion outside of each boundary of the performance zone (plus 50 m tolerance) will be separately registered. The time of the excursion will be determined by the Line Judges. The pilot will receive two penalty points for each second spent outside of the performance zone. In the case of differences in the time recorded by two Line Judges, the average value shall be used in calculating the penalty points.

In the event of a competitor flying around the outside of a corner, then the total time recorded by the line judge at that corner shall be taken as the correct time for this excursion.

- 2.4.2.2. All figures of a programme even when they are flown outside of the side boundaries of the performance zone (exception 2.3.1.d) are given marks; however wide excursions may influence the position mark.
- 2.4.2.3. Figures flown far outside of the performance zone may be given a mark of zero because of poor visibility.

2.4.3. Programme Interruptions

- 2.4.3.1. Each programme interruption will be given 70 penalty points. A programme interruption is a direction change of more than 90° that is not designated in the flight programme (exception: manoeuvres covered by 2.4.3.2). These can be:
- a) an interruption of a programme in order to return to the performance zone,
 - b) an intentional programme interruption with arbitrary direction changes (e.g. full circles).
- 2.4.3.2. If a pilot is compelled to change his direction after a mistake or after an abandoned figure in order to resume the predetermined direction and has already received a zero mark for that figure, no penalty points for an interruption will be subtracted (see also 2.3.1.1.d). This correction of direction or orientation should not be more than a heading change of 180 degrees or attitude change of more than one half roll or loop.
- 2.4.3.3. The pilot should not rock the aircraft's wing before or after a programme interruption. Wing rocking notes the final conclusion of the programme.
- 2.4.3.4. A programme interruption in order to gain altitude by thermalling will lead to disqualification for that flight programme.



2.4.4. Violation of Training

- 2.4.4.1. Training for the Unknown Compulsory Programme will lead (cf. 1.2.3.8) to disqualification from entire contest.
- 2.4.4.2. The pilot will be assigned 200 penalty points for each occurrence of a training manoeuvre which is not part of the current programme.

2.4.5. Failure to Appear

- a) In the case of the failure of the participant to appear at the designated take-off time, the pilot can be changed to the end of the current programme in the Known Compulsory and the Free Programmes, however he will receive a warning and 300 penalty points for that flight. If the same pilot fails to appear again, he/she will not be allowed to start in that programme.
- b) In the case of the failure to appear at the designated take-off time for the Unknown Compulsory Programme, the participant will not be allowed to participate in that flight programme. Deviations from this rule can be made on a case by case basis only by the International Jury.
- c) In urgent cases the participant may report late to the starter, but the variation from the stated rules can only be determined by the International Jury.

2.4.6. No Wing Dip at the Beginning or End of a Programme

- 2.4.6.1. The pilot will be given 35 penalty points for failure to do a wing dip at either the beginning or ending of a programme (or doing it so little that it is not apparent to the grading judges).
- 2.4.6.2. The Line Judges stop considering boundary infringements at the first wing dip marking the end of the flight programme or, in case that it is not seen, 10 seconds after the aircraft leaves the performance zone after the end of the last figure.

2.4.7. Flight Regulations and Dangerous Flying

- 2.4.7.1. Competitors found guilty of violating flight regulations and/or causing a dangerous situation will, on the recommendation of the International Jury, be disqualified by the Contest Director.



APPENDIX 1 TO CIVA REGULATIONS (PART TWO) **CRITERIA FOR JUDGING GLIDER AEROBATIC FIGURES**

A. PREFACE

The following is an expansion and clarification of the general principles for marking glider aerobatic figures stated in CIVA Regulations, Part 2, paragraph 2.1.2.

Basic judging principles are the same in power and glider aerobatics; nevertheless, there are also some fundamental differences. Remember, a Fox or Swift is not a Sukhoi or Extra minus an engine! Aerobatic gliders are still sailplanes, albeit optimized for aerobatics rather than distance soaring. Compared to an aerobatic airplane, a glider has lower limiting load factors with an airfoil which is a compromise between good aerobatic performance and high lift/drag ratio. The relatively long wingspan and high aspect ratio found on gliders produce only moderate roll rates both in slow rolls and flicks.

The final mark awarded to a figure has many components, but first and most important in any mark is the geometry of the figure as compared to the true horizon and Aerobatic Box axes. Geometry is derived from two distinctly different entities: flight path and attitude.

Next to figure geometry, harmony is the second most important factor of glider aerobatic performance. It is one of the most difficult – and least understood – tasks of glider judges to mark the harmony of a glider program correctly. The main factors determining the harmony of a glider program are efficient energy management and even figure spacing.

B. DEFINITIONS

The following expressions are used consistently throughout the text in a very precise sense according to these definitions:

Angle of Attack The angle at which the wings of an aircraft meet the relative airflow.

Angle of incidence The angle at which the wing is attached to the aircraft.

Figure Each individual component of a sequence, which may comprise one or more manoeuvres in combination; it starts and ends with a horizontal line.

Manoeuvre Any one of the basic aerobatic movements, which may be combined to make a figure (e.g., an avalanche is one figure consisting of two manoeuvres – loop and flick roll).

Mark/Point/Score **Marks** are assigned (from 0 to 10) by judges, and may be devalued by various **point** values. The **score** is calculated by multiplying the judges' marks by the coefficients (K factors) and adding the products.

Plane of Flight There are three planes of flight in aerobatic competition relative to the true horizon: horizontal, vertical and 45 degrees.

C. FLIGHT PATH AND ATTITUDE

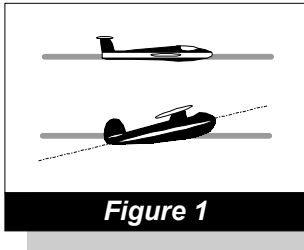

Flight Path

Think of the aircraft condensed into a single dot and watch the path this dot takes through the sky. This is the flight path, or track, of the aircraft's center of gravity. Judging the flight path consists of comparing the observed path with fixed references such as the horizon or the X and Y axes of the Aerobatic Box. (Figure 1)

Vertical Attitude

Judging vertical lines is based on the attitude of the aircraft and not its flight path. When an aircraft's flight path, in a zero wind condition, is exactly 90 degrees to the horizon, the wings are being held at the correct angle to produce no lift. The aircraft's attitude while in this condition (zero lift) defines the proper judging criterion for vertical attitude. This is called the zero-lift axis.

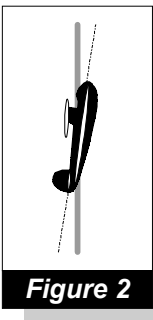

(a) When this zero-lift axis is vertical, the longitudinal axis of some aircraft may not appear to be vertical. (Figure2) This is especially true for most gliders; where, because the wing is attached at an angle of incidence of several degrees, and the airfoil is not symmetrical, a negative angle of attack is required to produce zero lift. The Judge must determine the proper vertical attitude for each aircraft type according to its zero-lift axis. The best opportunity to make this determination is to observe practice flights and note the different vertical attitudes, both up and down, of various glider types.

(b) An aid for judging the perfect vertical (zero-lift) attitude is to observe vertical rolls. During a truly vertical roll, the aircraft's wings will constantly be parallel to the horizon, something which is especially noticeable after 90 degrees of roll.

(c) Be aware that aircraft types whose zero-lift axis does not pass through the tail will make a spiral with the tail during a perfect vertical roll. From the Judges' perspective, this spiral will look as if the tail is shifting off-axis from the zero-lift axis flight path.

(d) When there is a wind of any kind, the observed flight path will be offset from perpendicular to the horizon by some degree. This wind effect must be completely ignored by the Judge, who must only evaluate the accuracy of the vertical attitude. (Figure 3)

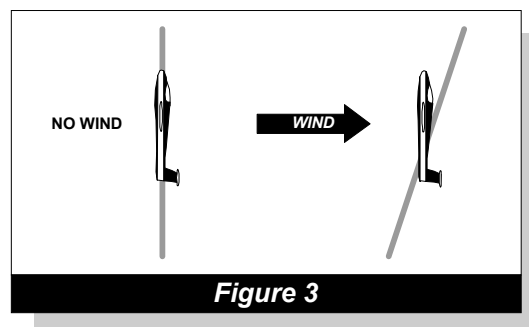

The 45 Degree Attitude

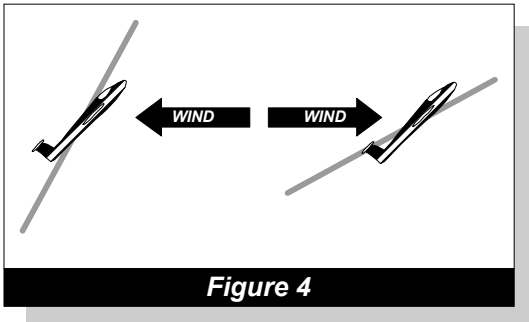

This is the vertical attitude plus or minus 45 degrees. In view of the difficulty in judging 45 degree lines accurately, scoring deductions should be applied with care. When flown into the wind, a perfect 45 degree line will appear to be steep while the opposite is true when flown downwind. (Figure 4) As with the vertical attitude, this wind effect must be completely ignored by the Judge who must only evaluate the accuracy of the 45 degree attitude.

Gliders gain airspeed on 45 degree down lines and lose airspeed on 45 degree up lines. When the pilot keeps the zero-lift axis at the prescribed 45 degree angle to the horizon, the flightpath becomes flatter on the up line as lift decreases with airspeed as well as on the down line when lift is increased with increasing airspeed. These changes in the flightpath angle must also be ignored when judging 45 degree lines. The prescribed deduction is one (1) point per five (5) degrees of deviation from the correct geometry (0.5 points per 2.5 degrees).

D. MARKING

It should be assumed that a competitor is going to fly a perfect figure, so a Judge starts with a mark of 10. As the figure is performed, the Judge then begins to find faults (if any) with what he or she sees, and starts downgrading as the figure progresses. This system of marking is required by the rules as opposed to waiting until the figure is finished and assigning a mark based on overall impression. The latter causes the judging to be erratic and inconsistent.

Summary

Remember, it is the Judge's job to find fault: be a nit-picker. On the other hand, give a mark of 10 if you see a perfect figure – but if you are really being critical you won't see too many. Don't get in a rut. Guard against confining your marks in too narrow a range. If you watch carefully and mark consistently, you will find yourself giving an occasional 2, 3, or 4 on some sloppy figures that are not quite bad enough for a zero. You will also be giving an occasional 9 or 10 for the superlative figure with which you can find little or no fault. Take care not to mark on an overall impression of a flight. Be ready to award a low mark for a poor figure even if you have been marking other figures flown by that competitor with 8's and 9's.

On the other hand, when you see a competitor barely getting through the figures and you have been giving 4's and 5's, don't be afraid to award a 9 for the almost perfect 90 degree turn that you just saw.

Finally, and most importantly, only mark what you see. If you can't see anything wrong with a figure, don't deduct any points, even if you think there must be something wrong. Always give the competitor the benefit of the doubt.

E. WIND CORRECTION

There are two kinds of wind correction: correction for figure geometry (shape) and correction for Aerobic Box positioning.

The competitor is required to make the shape of all loops and part-loops within a figure perfectly round as seen by the judge on the ground. Wind correction is required for loops and part-loops within figures so that the aircraft's flight path describes a constant radius circle or part circle. Remember, the Judge marks for the roundness of the flight path. Any deviation from perfect roundness must result in a reduction of the mark for that figure.

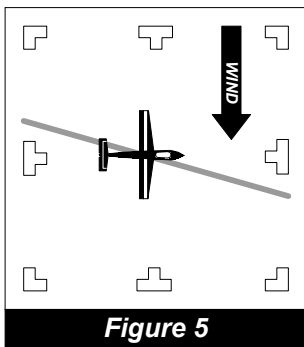

The competitor is also required to keep the aircraft within the Aerobic Box. This becomes more of a problem when a wind is blowing at an angle to the X axis. (Figure 5) The primary method of dealing with cross-box drift is to include a "wind corrector" figure in the sequence. A wind corrector is a figure which places the aircraft onto the Y axis. Because the Y axis is non-directional, the competitor can turn onto the Y axis in the direction which will allow an upwind position change before flying a subsequent figure which returns the aircraft to the X axis.

A well designed Free Program will always include at least one, and preferably more, wind corrector figures. Not every Known Compulsory or Unknown Program contains sufficient (or any) wind corrector figures. In this case, it is up to the competitor to keep the aircraft within the Aerobic Box without benefit of a specific Y axis figure to accomplish it. A common approach is to crab into the wind as done in navigational flight. (see Figure 6) Crabbing means that the aircraft's heading is at an angle to the competition axis (X or Y). The downside to this approach is that if this heading angle can be detected by the Judge, a deduction of one (1) point per five (5) degrees will be given.

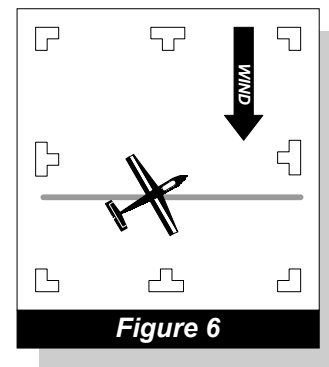

It is possible for the competitor to correct for wind in such a manner that the attitude remains absolutely true to the correct geometry of the figure but the flight path has a sideways component. It goes beyond the scope of this document to provide a tutorial on how this may be accomplished, but what is clear is that if any yaw (heading) deviation or bank angle is visible to the Judge, the mark must be reduced at the rate of one (1) point for every five (5) degrees of deviation detected.

Please note, however: even if it is plainly evident that the aircraft has moved laterally within the Aerobic Box, if the method of that movement cannot be detected by the Judge, no deduction for such correction must be made.

F. THE TWO BASIC COMPONENTS OF AEROBATIC CONSTRUCTION: LINES AND LOOPS

Lines

All lines are judged in relation to the true horizon and the Aerobatic Box's axes. Horizontal lines are judged on flight path, not attitude. Different aircraft at different airspeeds will employ different attitudes to maintain a horizontal flight path. (see Figure1)

Gliders cannot maintain altitude without losing speed. In order to maintain airspeed, they must fly a descending flightpath. The glide angle at constant airspeed is determined by the lift/drag ratio of the specific glider at that speed. So, depending on airspeed and glider type, glide angles may vary considerably.

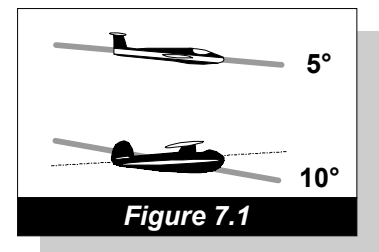

Figure 7.1

For this reason, the flightpath for horizontal lines in glider aerobatics may be inclined between zero (0) and ten (10) degrees below the horizon (Figure 7.1). Deviations above or below this bracket will be downgraded by one (1) point per five (5) degrees.

While maintaining a horizontal flight path, the aircraft's heading must remain parallel to the X or Y axis. The deduction for deviation in either axis is one (1) point per five (5) degrees from the correct geometry.

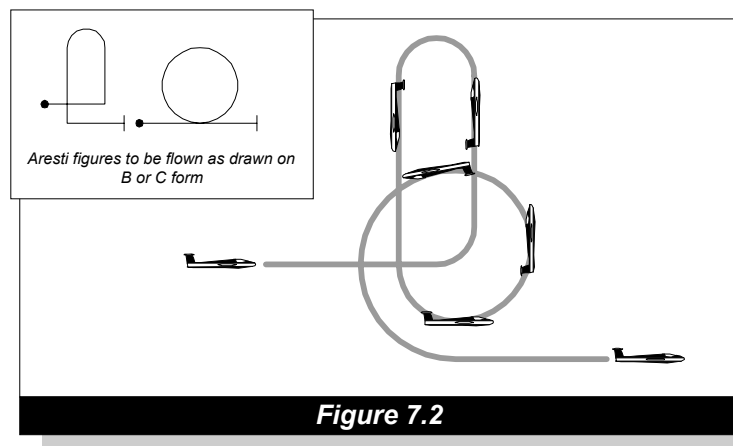

Figure 7.2

(a) All figures begin and end on definite horizontal lines, and both must be present in order to earn a good mark. A competitor who rushes from one figure to another without showing this horizontal

and well-recognizable line will be downgraded by one (1) point for each missing line in each figure affected. Therefore, leaving out the line between two figures will downgrade the preceding figure by one (1) point and the following figure by one (1) point. (Figure 7.2)

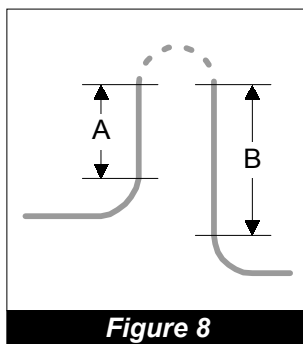
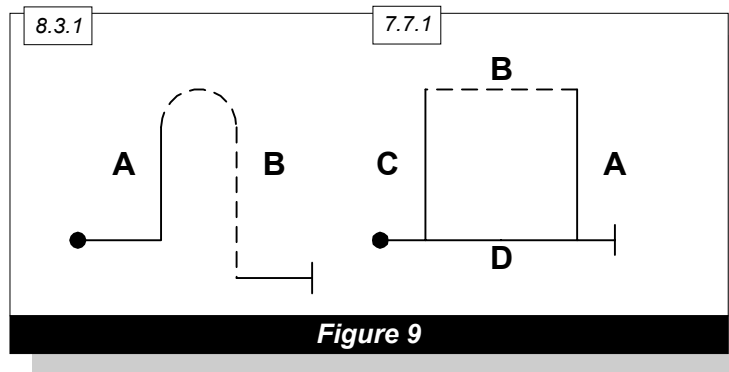

Figure 8

(b) All lines that occur inside a figure are preceded and followed by part-loops. (Figure 8) The absolute length of lines within a figure is in itself not a marking criterion. The corresponding attitude, however, must be maintained long enough to allow judges to observe the angle and determine any deviations from the prescribed plane of flight.

Excessively long lines must not be rewarded with higher marks and "rough" flying with high-G "square corners" must be penalized by reducing the mark for harmony.

(c) With the exception of Family 3 figures and some figures in Family 7, the criterion for the length of lines within a figure states that they do not have to be of equal length. Therefore, it is imperative that the judges become familiar with the specific criterion for the length of lines for each figure. For example, the length of the lines in a "Humpty-bump" do not need to be equal, but all four lines in a "Square loop" must be of equal length. (Figure 9)



(d) Whenever a slow roll or hesitation roll is placed on an interior line, the lengths of the two parts of the line before and after the roll must be equal. In gliders, the entry airspeeds for positive and negative flick rolls lie in a relatively narrow bracket. The pilot must be free, therefore, to determine the point on the line where he starts the flick roll. Because of this, no deduction will be made for flick rolls not centered on an interior line.

The line lengths before and after a roll are not a marking criterion when rolls are performed on a 90 degree downline following a spin.

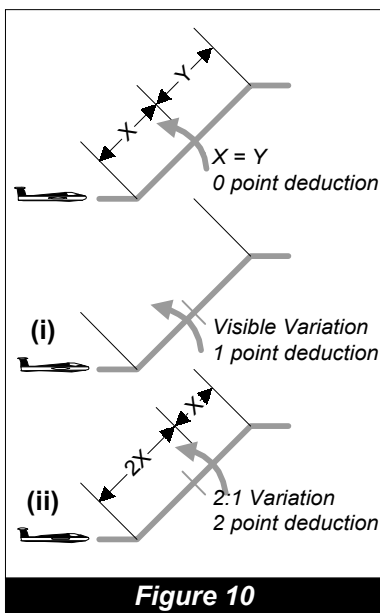

Some gliders have relatively slow roll rates and need practically the entire length of an interior line to complete a slow roll or hesitation roll. Therefore, it is sufficient to fly vertical or 45 degree lines before and after the roll just long enough to show that the preceding part-loop has been completed and the prescribed plane of flight is established. The absolute lengths of the lines before and after the roll are irrelevant for marking as long as they are equal.

Judges should take care to judge the symmetry of the length of lines in a figure using only the length of the lines and not by elapsed time taken to fly each segment. This difference in length versus elapsed time is most noticeable in figures where rolls are placed on up-lines. As the aircraft loses airspeed, the time it takes to fly a line after the roll will be greater than the time required to fly the line of the same length before the roll.

(e) If within a figure two or more lines must be of the same length, an observed variation is penalised by reducing the mark in the following manner: (Figure 10)

- (i) a visible variation - one (1) point deduction
- (ii) if the lengths vary by 1:2 or more - two (2) points deduction.

The basis for judging line lengths is the first line flown. The absence of one of the lines before or after a roll is penalised by one (1) additional point.

Example: The competitor is to fly a 45 degree up-line with a half slow roll on this line. Although there was a line before the roll, the glider was returned to level flight immediately after the roll. The correct deduction is three (3) points: two (2) points are deducted because the lengths of the lines differ by more than 1:2, and another one (1) point is deducted because of the absence of one of the lines.



(f) All 90 degree and 45 degree lines are preceded by a part-loop. When the glider completes the part-loop and reaches the prescribed plane of flight, the pilot must reduce the angle of attack to maintain the 90 degree or 45 degree attitude. For marking purposes, the judge must only look for the precise alignment of the glider's zero lift axis 45 degrees or 90 degrees relative to the horizon as soon as the part-loop has been completed.

Some pilots exaggerate the change in angle of attack when transitioning from loop to line. They overshoot the correct angle by several degrees, and then the nose of the glider is "bumped" back onto the line. Any visible "bump" in the transition from a loop or part-loop onto a line must be penalized by a one (1) point deduction.

Loops and Part Loops

All transitions from one plane of flight to another should have a reasonable and constant radius. The size of that radius is not a marking criterion and higher marks must not be given for high-G "square corners".

The loop is a figure from Family 7, but part-loops are integral to every other family so it is necessary to discuss the loop before going on to the other families.

(a) A loop must have, by definition, a constant radius. It starts and ends in a well-defined line which, for a complete loop, will be horizontal. For a part-loop, however, such lines may be in any other plane of flight and will be defined by the aircraft's attitude. As the speed changes during execution of a loop or part-loop, the angular velocity around the aircraft's lateral axis also has to change in order to keep the radius constant. When the speed decreases, for example, to half its initial rate, the angular velocity, to keep the same radius, will be reduced by half – this is a fact of physics. Thus, the angular velocity can be an aid for the Judge to gauge the radius – especially when the angular velocity in the higher part-loop is seen to be faster, as this is a clear indication that the radius is smaller. This aid becomes more important when two part-loops are separated by a line between.

(b) The part-loops of any one figure should all have the same radius, except in Family 1, 5 and 6 figures and where indicated in Family 8.1 thru 8.20 and 8.49 thru 8.56. For example, a figure starts on a horizontal line, with a quarter loop next, followed by a vertical line and then another quarter loop. The quarter-loop at the top of the vertical line (Family 1 figures) need not have the same size radius as the quarter-loop at the bottom. However, the top radius must not be a "corner" or very sharp angle. It must have a smooth, distinct and constant radius.

G. GAF CATALOGUE FAMILIES

FAMILY 1 – Lines and Angles

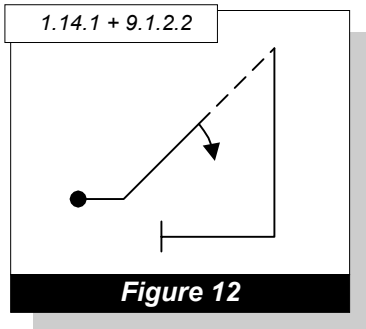

Family 1.1 to 1.11 has been fully covered in the preceding section. Note that the figures in Family 1.12 to 1.31 are NOT performed as drawn in the GAF Catalogue. (Figure 12) In each of these figures there are three (four in 1.28 - 1.31) looping components: a one-eighth loop, a three-eighths loop and a quarter loop. (Figure 13) Rolls may be performed on the 45 degree line and/or the 90 degree line, with the part-lines before and after the roll being of equal length, except positive or negative flick rolls and rolls following a spin.

The initial horizontal line and the line at the end of the figure may be flown at different altitudes.

The initial horizontal line and the line at the end of the figure may be

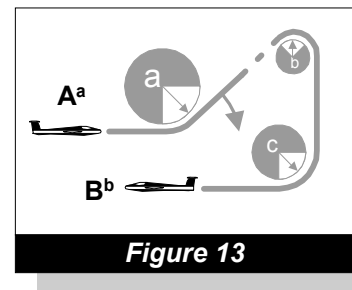

Family 1.12-1.19 as flown. Radii a, b, and c may all be different and entrance altitude "A" can be different from exit altitude "B".

FAMILY 2 - Turns and Rolling Turns

Family 2.1 - 2.2 Turns

Competition turns are not to be confused with standard coordinated turns (Figure 14). In aerobatic competition, a turn is divided into three parts:

- 1) establishing the bank using a roll on heading;
- 2) the turn itself; and
- 3) a roll back to straight and level flight on heading.

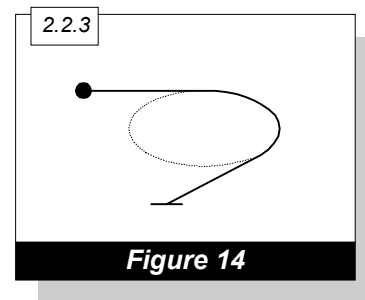

Let's look at the turn during each of these three parts.

First, the roll to establish the bank. This must be a roll of 60 degrees, it must be performed on the entry heading, and the aircraft must maintain a constant glide (0 to 10 degrees below the horizon).

Once the roll is completed and the angle of bank is established, the competitor immediately performs the turn. The turn must maintain 60 degrees of bank throughout. The aircraft must also maintain a constant glide (0 to 10 degrees below the horizon). The rate of turn is constant throughout and is NOT wind corrected. Therefore, in wind, a 360 degree turn will not appear as a perfect circle.

As soon as the glider is on the exit heading, the competitor performs another roll at a rate equal to the entry roll. Again the aircraft must maintain a constant glide (0 to 10 degrees below the horizon).

Downgrades:

1. The angle of bank established by the initial rolling maneuver must be exactly 60 degrees. Any deviation is a one (1) point deduction for every five (5) degrees.
2. The angle of bank, once established, must remain constant. Any deviation is a one (1) point deduction for every five (5) degrees of deviation.
3. The rate of roll must be the same for the entry and exit rolls of this figure. Any deviation is a one (1) point deduction.
4. The aircraft must maintain a constant glide (0 to 10 degrees below the horizon) throughout the figure. Any deviation above or below is one (1) point for every five (5) degrees.
5. The rate of turn must remain constant. Any change would be not more than a one (1) point deduction for each change. Note that the rate of turn may appear to change in a strong wind, when it really isn't changing. The Judge must always keep the wind in mind and give the pilot the benefit of the doubt if there is any question.
6. The aircraft must begin and end on the prescribed heading. Any deviation is a one (1) point deduction for every five (5) degrees of deviation.

Family 2.3 - 2.20 - Rolling Turns

The rolling turn is a figure that combines a turn of a prescribed amount with a roll or rolls integrated throughout the turn. (Figure 15).

These rolls may be in the same direction as the turn and are called "rolls in" or "rolls to the inside". They can be rolls in the opposite direction of the turn and are called "rolls out" or "rolls to the outside". Or there can be rolls alternating in and out.

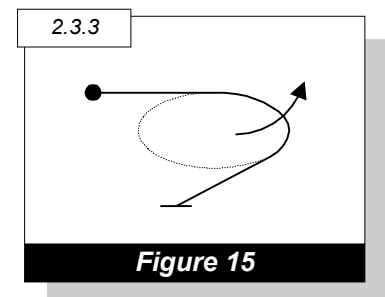

When we say that the rolls are integrated, we are saying that in addition to there being a constant rate of turn throughout the figure, the rolls must also be synchronised with the turn.

For example: In a 180 degree rolling turn with two rolls from upright (Catalog Numbers. 2.6.1 or 2.6.3) the glider must be inverted after 45 and 135 degrees of turn and upright at 90 and 180 degrees.

Any deviations from the prescribed direction at the intermediate points when the glider is wings level will be downgraded by one (1) point per five (5) degrees.

At the end of the figure the aircraft must be wings level and on the prescribed heading.

When a rolling turn is performed with rolls alternating directions, the aircraft must change direction of roll at a wings level attitude whilst continuing the turn. There must be no recognizable pause when reversing roll directions.

Downgrades:

1. Performing more or fewer rolls than the catalog description calls for results in the figure being zeroed.
2. All rolls in a rolling turn are slow rolls. If a flick roll is performed or a stall occurs, the figure is zeroed.
3. Each stoppage of the rate of roll is a deduction of one (1) point.
4. One (1) point per five (5) degrees will be deducted for variations in direction every time the glider is wings level (upright or inverted).
5. A recognizable pause when reversing roll directions will be downgraded by one (1) point.
6. Variations from the constant glide (0 to 10 degrees below the horizon) are deducted by one (1) point per five (5) degrees.
7. One (1) point for every five (5) degrees of bank when reversing roll direction.
8. One (1) point for every five (5) degrees of roll remaining when the aircraft has reached its exit heading.
9. One (1) point for every five (5) degrees of turn remaining when the aircraft has completed its last roll.

FAMILY 3 – Combinations of Lines

The transition from level flight to 45 degree lines should be at a constant and reasonable 1/8 looping radius. All lines within the figure should be equal in length. The 45 degree transitions in Family 3.1 should have a constant and reasonable radius and not (as drawn) a sharp corner. (Figure 16)

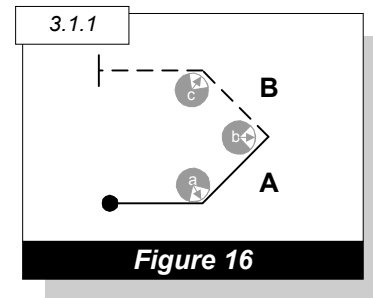

FAMILY 5 - Stall Turns

Stall turns are some of the most graceful figures in the GAF catalog. In its most basic form (Figure 17), the figure begins when the aircraft leaves horizontal flight and flies a quarter loop to establish a vertical climb. At the top of the vertical line, the aircraft pivots and establishes a vertical descent, with the figure ending as the aircraft is returned to horizontal flight.

The judging criteria are:

1. The entry and exit quarter loops must be flown with a reasonable and constant radius.
2. The vertical lines, both up and down, must be flown on the zero-lift axis. (see Figure 2)
3. Any deviation from vertical, either up or down, will result in a deduction of one (1) point per five (5) degrees from the zero lift axis.
4. Any added roll(s) must be in the vertical climb or vertical descent and positioned so that the lines before and after the roll are of equal length (except positive or negative flick rolls) (Figure 18). For deductions see F.1.(e).
5. The length of the vertical up and down lines need not be equal. As such, the altitude of the horizontal lines at the start and finish of the stall turn may be different.
6. During the vertical climb or vertical descent, the wings must remain parallel to the horizon. There will be a one (1) point deduction per five (5) degrees, when the line connecting both wing tips deviates from horizontal.
7. As the glider nears the point where it would stop climbing, it must pivot in a plane parallel to vertical. To avoid a deduction, it must pivot around a point which should not be farther away from its center of gravity than its wingtip. When the radius of the rotation is greater, the downgrade is one (1) point per half wingspan. (Pivot Point D, Figure 19)

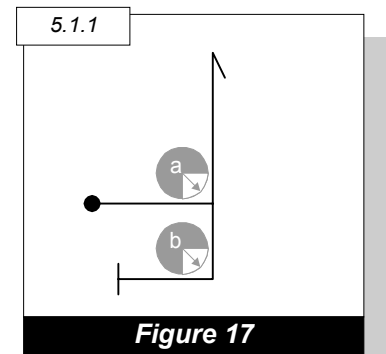

Figure 17

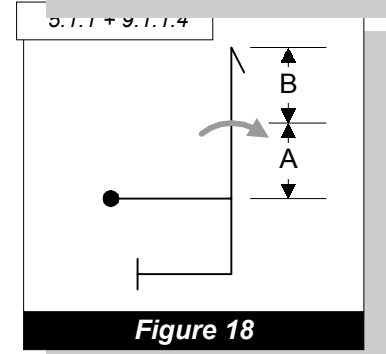
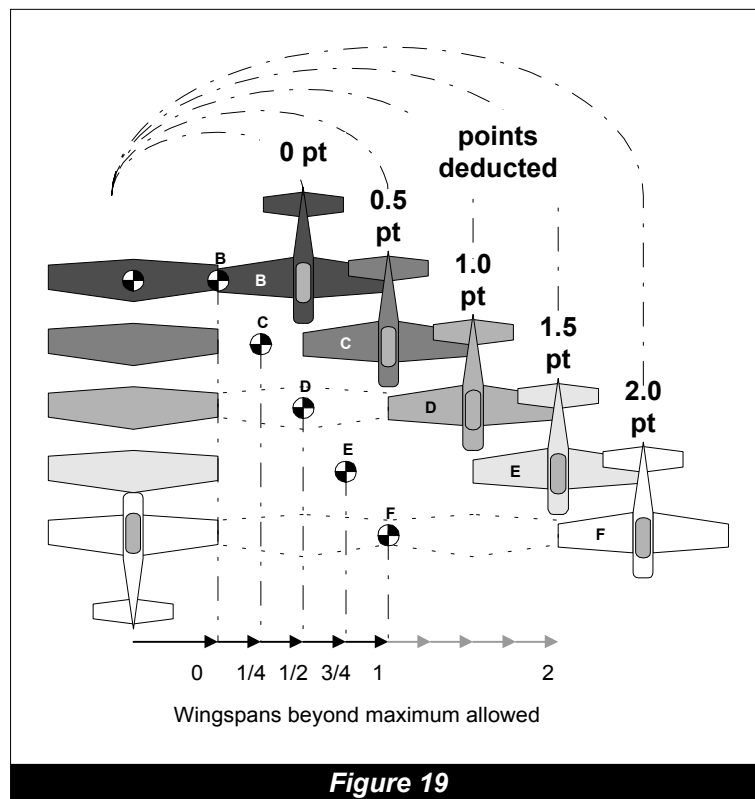

Figure 18



8. The rate at which the aircraft pivots around its vertical axis is not a judging criterion. If, however, the glider slides down sideways whilst pivoting around its vertical axis, this "wing slide" must be downgraded by at least one (1) point depending on the severity of the slide.

9. The wings must remain in the vertical geometric plane throughout the turnaround, and the aircraft's attitude before and after the turnaround must be absolutely vertical, with no extraneous movement. There must be no rotation around the longitudinal or lateral axes. If there is movement around any axis other than the yaw axis, often referred to as "torquing" (Figure 20), there is a deduction of one (1) point for each five (5) degrees off axis.

"Torquing" is rotation about the longitudinal axis during turnaround.

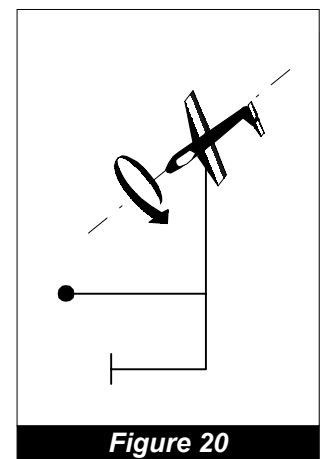

FAMILY 6 – Tailslides

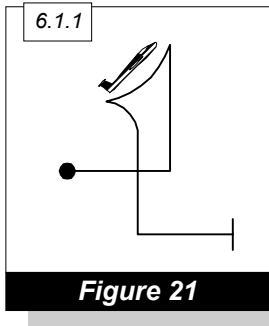

Figure 21

All the criteria of the Stall Turn apply to this figure except, of course, for the maneuver at the top of the vertical climb. At the point when the aircraft stops, it must slide backwards a visible amount (the key here is "a visible amount"). If there is no slide, the grade is zero (0).

Following the slide backwards, the aircraft must then tip over and fall through to a diving position. The tipping over must be around the lateral axis only. Any movement around another axis is downgraded by one (1) point per five (5) degrees.

Often the nose will swing back or "pendulum" past the vertical after falling through. The figure is not to be downgraded for this, nor downgraded if it does not happen. It is a function of the length of the slide and the type of aircraft, and is not to be considered in marking the figure.

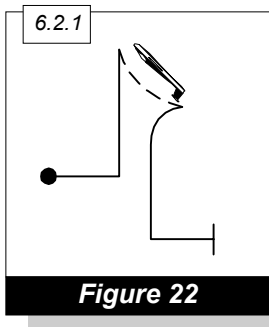

Figure 22

There are two types of tailslides: wheels-down (also called "canopy-up") and wheels up (also called "canopy-down"). The wheels-down tailslide is depicted in the Aresti diagram with a curved solid line at the top of the tailslide symbol. (Figure 21) The wheels-up tailslide is depicted in the Aresti diagram with a curved dashed line at the top of the tailslide symbol. (Figure 22)

This figure must be watched carefully, as the aircraft can fall the wrong way (which is marked zero) with the correct direction of flight and the proper aircraft attitude still maintained. Wings should stay level with the horizon throughout and not drop during the slide or the fall through. Watch for the aircraft torquing off the correct plane of flight, which must be downgraded.

Also watch for "cheating" on the vertical line up in the direction of the slide just prior to sliding. (Figure 23) On this line of the tailslide a non-standard deduction of two (2) points per five (5) degrees of deviation applies. The entry quarter loop and the exit quarter loop must be flown with reasonable and constant radii. The altitude of the entry and exit horizontal lines need not be the same and the figure must not be downgraded if they are different.

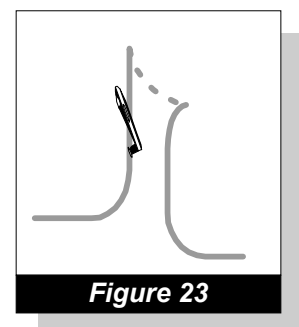

Figure 23

When rolls are combined with Family 6 figures, there must be an equal length of line before and after the roll(s) (except positive or negative flick rolls). In the vertical downline, the aircraft must attain a vertical attitude and establish a downline before starting the roll(s).

In summary, the aircraft should make a smooth and steady transition up to vertical flight, the wings should stay level in relation to the horizon, and the aircraft should come to a complete stop in this attitude. After sliding backward a visible amount, it should fall through in the appropriate direction without dropping a wing or the nose moving off axis, and recover on the same plane as that of entry. After completion of this, it should again project the 90 degree down line before transitioning into horizontal flight with a quarter loop of reasonable and constant radius.

FAMILY 7 – Loops and Figure 8's

The size of a loop is not a marking criterion. It will vary according to the flight characteristics of the aircraft. A large loop is not marked any higher or lower than a small loop. But any variation to the radius will downgrade these figures.

Family 7.1 - 7.4 - Half-Loops With Rolls

The half-loops in this sub-family must be of a constant radius and wind-corrected to appear as a perfect half circle (see full loops discussion below).

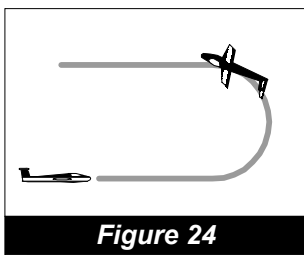

Figure 24

Aircraft rolls five degrees early before reaching horizontal flight. Deduction of one point is given.

When a half-loop is preceded by a roll or rolls, the half-loop follows immediately after the rolls without any visible line. Drawing a line requires a downgrade of at least two (2) points depending on the length of the line drawn. Should the half-loop begin before the roll is completed, the Judge must downgrade the figure one (1) point for every five (5) degrees of half-loop flown on which the roll was performed.

The half-loop followed by a roll is also flown with no line between the half-loop and roll. Again, drawing a line requires a downgrade of at least two points depending on the length of the line drawn. Should the roll begin before the half-loop is completed, the Judge must downgrade the figure one (1) point for every five (5) degrees of half-loop on which the roll was performed. (Figure 24)

Family 7.5 - 7.6 - Full Loops

All full loops must appear perfectly round to the Judge. This means that they must be wind corrected to have a constant radius. This wind correction is only with regards to the roundness of the loop and not for the effect of any crosswind on the figure. Therefore, no deduction is given if the finish point is displaced relative to the start point in a direction perpendicular to the plane of the loop.

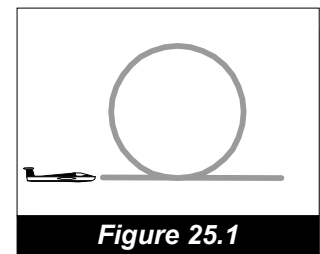

Figure 25.1

Full loops must also begin and end at the same altitude or they will be downgraded. (Figure 25.1)

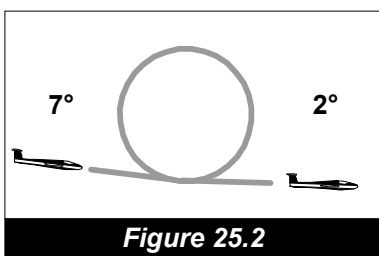

Figure 25.2

In glider aerobatics, the entry and exit lines of the loop may be inclined 0 to 10 degrees below the horizon and the inclination may be different for entry and exit lines within the above tolerances (Figure 25.2).

Loops must be flown with no visible crabbing and wings must be level at all times. The one (1) point for every five (5) degrees rule holds for both these cases.

If there is a roll or rolls at the apex of the loop, it must be centered in the loop and flown on the arc of the loop itself. Flying the roll on a line at the apex of the loop is at least a two (2) point downgrade. If the roll is not centered, it must be downgraded one (1) point for every five (5) degrees of the arc that it is off center.

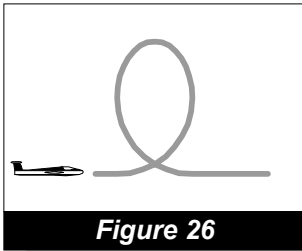

Figure 26

To better quantify deductions for irregularity of the radius of looping figures, the Judge divides the loop into quadrants. Any variation in the radius from one quadrant to the next can be downgraded a fixed number of points depending on the magnitude of the variation.

The goal of each Judge is to develop a reproducible method to judge all loops with the same criteria.

In judging loops, a common error is for the vertical diameter of the loop to be larger than the horizontal diameter. This is often called an "L" shaped loop (Figure 26).

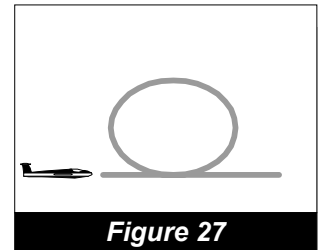

Figure 27

Less common are loops with a horizontal diameter greater than the vertical. This is called an egg-shaped or pumpkin-shaped loop (Figure 27).

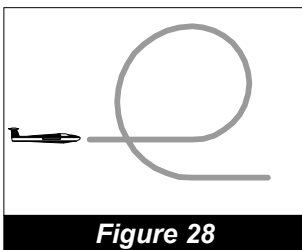

Figure 28

Another common error is in varying the radius of the final quadrant performing an "e" shaped loop (Figure 28).

Whatever method is used, standard downgrades should be applied for each of these errors. Additional downgrades should be applied based on the magnitude of variation.

Family 7.7 - 7.10 - Square, Diamond and Octagon Loops

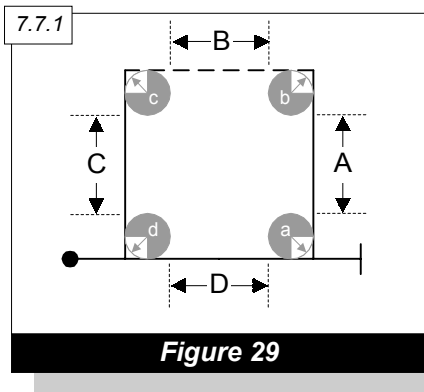

Figure 29

Square and Octagon loops are flown as hesitation loops with lines of equal length and partial loops with equal radii. All horizontal lines are judged on flight path and vertical and diagonal lines are judged based on aircraft attitude. As such, except in a windless condition, the judge should never expect to see these figures closed. They will always be driven by the wind. Square and Octagon loops are not considered complete until the last horizontal line is drawn equal to the length of the first line of the figure. (Figure 29)

Radii $a = b = c = d$
Line Length $A = B = C = D$
Figure is not complete until $D = A$

Where rolls are flown on the Square or Diamond loops, they must be centered on the line (except positive or negative flick rolls).

Aids for judging all hesitation loops are that a good performance will contain changes of angular velocity in all the partial loops, and variations of time taken to draw the length of each interior line, which also varies according to the aircraft's speed. The rhythm of all these partial loops is a help for judging. A frequently seen error in hesitation loops is for the aircraft to overshoot the partial loop and then have to bring the nose back to correct the attitude. This must be downgraded by one (1) point for every five (5) degrees.

Family 7.19 - 7.22 - Partial 8's

Sometimes referred to as "Goldfish", the entry, 3/4 loop, and exit radii in these figures must all be identical. The entry and exit lines are judged with reference to the 45 degree attitude, not flight path. Any rolls, except positive or negative flick rolls on the 45 degree lines must be centered on that line. It is not required that the lengths of the 45 degree lines bear any strict relation to the diameter of the three quarter loop. That is, the entry and exit altitudes need not correspond to the altitude limits of the loop. (Figure 32)

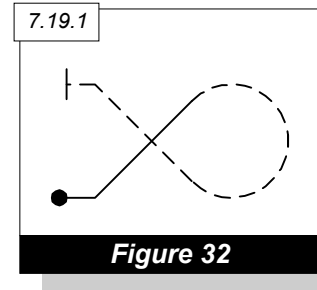

Family 7.23 - 7.30 - Horizontal 8's

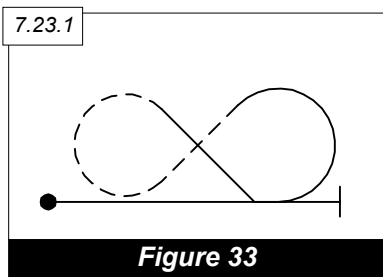

Both loops must be the same size and the lines between the loops flown at exactly 45 degrees attitude. This means that only if there is no wind will they intersect at the exact midpoint of the 8. If there are rolls of any variety, they will only occur on the 45 degree lines and, except positive or negative flick rolls, be positioned so that the lines before and after the roll are of equal length. For deductions see F.1.(e).

The start and finish of the figure and the bottoms (or tops if the figure is reversed) of the two loops need not be at the same altitude.

All part-loops between 45 degree and horizontal lines should have the same radii as the loops of the Horizontal 8 itself. A common fault is to fly these part-loops as drawn in the catalog symbol, which means with a corner. This must be downgraded. (Figure 33)

Family 7.31 - 7.38 - Combination 8's

Besides possessing the unique characteristic of containing three degree lines on which rolls may potentially be placed, this family can be thought of as two linked Partial 8's (sub-families 7.22). Radii of the entry/exit 1/8 loops and the two 3/4 loops all be equal. Each of the 45 degree lines may be of different lengths, but any rolls except positive or negative flick rolls placed on them must be centered. The two 3/4 loops need not occur at the same altitude, nor is there any strict relationship between the horizontal entry/exit altitudes and the altitude limits of the two 3/4 loops. (Figure 34)

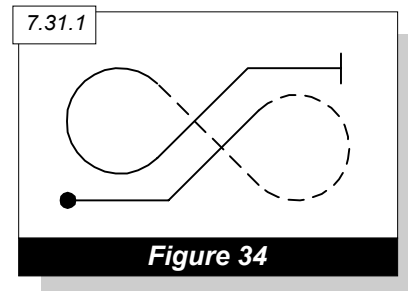

45
7.19-
must

FAMILY 8 – Combinations of Lines, Loops and Rolls

These figures are combinations of horizontal, vertical and 45 degree lines as well as partial loops of varying degrees. The judging criteria for these lines and loops are unchanged. What is left to discuss are the judging criteria for the combinations of these lines and loops.

Family 8.1 – 8.28 – Humpty Bumps

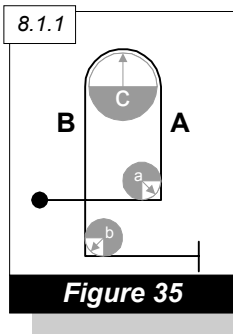

These figures, whether vertical or performed with 45 degree lines, are judged as combinations of lines and loops. For all these figures, the radii of the first and last partial loop must be equal. However, the half loop in the middle of the figure can be of a different radius. These half loops must still have a constant radius from the time they depart the vertical or 45 degree line. This requires a change in angular velocity during the half loop. (Figure 35)

The lines in these figures may be of different lengths, and therefore the entry and exit altitudes of these figures can be different. Rolls on any of these lines except positive or negative flick rolls and rolls following a spin must be centered.

*Radius a = b
 but c does not
 equal a or b.*

Family 8.29 - 8.48 and 8.51 - 8.54 - 7/8 Loops, Reverse Half Cubans, 3/4 Loops, Half Cubans

In these figures, all partial loops must have the same radii. The rolls on vertical and 45 degree lines except positive or negative flick rolls and rolls following a spin must be centered. Horizontal rolls immediately preceding or following looping segments have the same criteria as in Families 7.1 to 7.4. (Figure 37) Angles drawn in the GAF Catalogue, are to be flown as partial loops.

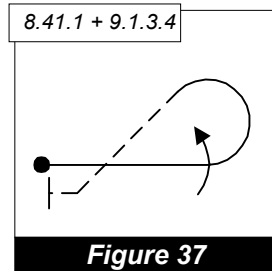

Family 8.49 - 8.56 - Multiple Looping Combinations

When 1/4, 1/2 and 3/4 loops join each other in these sub-families, their radii must be equal and there is no line between the loops. (Figure 38) A line drawn would be a minimum two (2) point deduction depending on the length of the line. An exception is the 1/4 loop that returns the aircraft to horizontal flight, which should have a reasonable radius, but need not match the other looping radii.

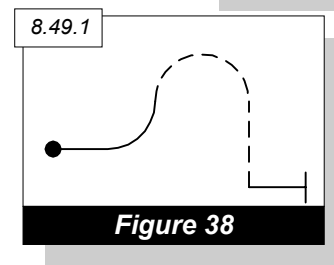

Family 8.57 - 8.68 – Teardrops

In these figures, all partial loops must have the same radii. The rolls on vertical and 45 degree lines except positive or negative flick rolls and rolls following a spin must be centered. Angles drawn in the GAF Aerobatic Catalogue are to be flown as partial loops.

FAMILY 9 – Rolls and Spins

Rolls may be performed on horizontal, 45 degree or 90 degree lines; on complete loops; between part-loops; between part-loops and lines; and following spin elements.

They may be 1/4, 1/2, 3/4 or a full 360 degrees in their rotation, up to two consecutive full rolls. Additionally, slow rolls may be flown in combination with turns as prescribed in Family 2 (Rolling Turns).

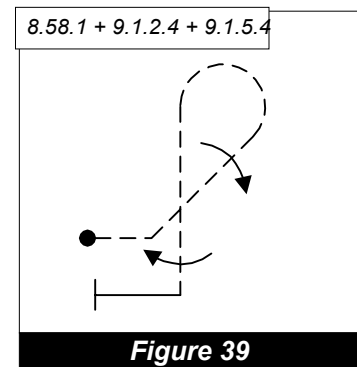

Figure 39

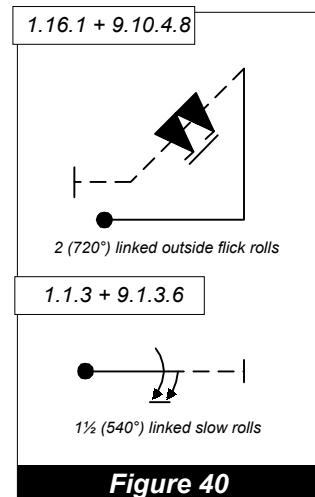

Figure 40

In all cases, the same criteria apply: the rate of roll must be constant throughout the roll(s). The aircraft should continue to project, during the rolling portion, the prescribed plane and direction of flight.

Multiple rolls may be linked, unlinked, or opposite.

- (1) When rolls are in continuous rotation, the tips of the symbols are linked by a small line. When flying linked rolls there is no pause between them. (Figure 40)
- (2) Unlinked rolls must be of different types, the two types being defined as follows:

- (i) Aileron rolls (slow rolls and hesitation rolls)
- (ii) Flick rolls (positive and negative)

No line links the symbols, though their tips are drawn pointing in the same direction (i.e., on the same side of the line). They must have a brief

but perceptible pause between them and they are to be flown in the same direction of rotation. (Figure 41)

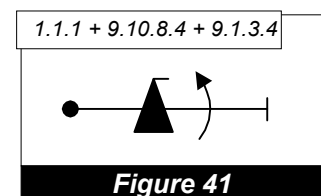
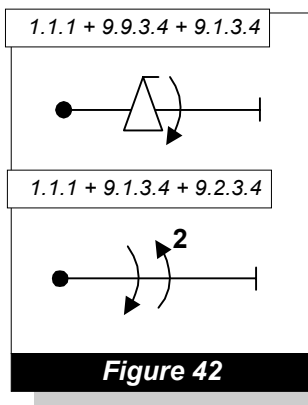

Figure 41

- (3) Opposite rolls may be either of the same or different type. In opposite rolls, the tips of the symbols are drawn on opposite sides of the line, indicating they are to be flown in opposite directions of rotation. The pilot may elect to fly the first roll in either direction, but the second roll must be opposite direction to the first.



Opposite rolls, including those in rolling turns, should be flown as one continuous maneuver - the brief check between opposite rotations should be minimal. (Figure 42) If the two rolls are of the same type, they must be flown in opposite directions if they are not linked.

(4) Either aileron or flick rolls may follow spin elements (Family 9.11 or 9.12). When a spin and a roll are combined on the same vertical downline they will always be unlinked; may be flown in either the same or opposite direction, as shown by the position of the tips of the symbols on the Form B or C; and the combination may not exceed two rotational elements. (For example, it would be illegal to combine two opposite direction aileron rolls with a spin element.)

Families 9.1 and 9.13 - Slow Rolls and Super-Slow Rolls

The penalty for varying the rate of roll is one (1) point per variation. Any stoppage in the slow roll that could result in its being considered a hesitation roll, would zero (0) the figure. The finish of the roll must be as crisp and precise as possible. Coming to a slow finish in fact represents a change in the rate of roll and should be penalized accordingly.

The marking criteria for Super-Slow Rolls are identical to Slow Rolls, but the average rotation rate of Super-Slow Rolls must not be more than 36 degrees per second (minimum 5 seconds for one half roll; 10 seconds for one roll; 15 seconds for one and one half roll)

The wings must stop precisely after the desired degree of rotation and not go past the stop point and then return. This is referred to as "bumping the point". A deduction of 0.5 point to one (1) point is given depending on the severity of the "bump"

Family 9.2 - 9.8 - Hesitation Rolls

These rolls are judged on the same criteria as the slow roll, only the aircraft stops rotation during the roll for a pre-stated number of times, i.e., 2, 3, 4 or 8. The rate of the roll and the rhythm of the hesitations must be constant throughout with the aircraft projecting the pre-stated plane and direction of flight. The pauses will be of identical duration and the degree of rotation correct between each pause: 180 degrees, 120 degrees, 90 degrees, or 45 degrees. Each pause of a hesitation roll must be clearly recognizable in every case, but it is especially important that in poor visibility or at high altitude, the competitor pauses long enough to make them recognizable to the Judges. If a pause is not recognizable, the figure is marked zero (0).

"Bumping the point" will be downgraded by 0.5 point to one (1) point depending on the severity of the "bump" for each occurrence.

Family 9.9 - Positive Flick Rolls

Flick rolls represent one of the greatest challenges to judges. This is primarily due to two factors: (1) the "flicking" characteristics of different types of aircraft are unique; and (2), flick rolls are a high energy maneuver that occur very quickly. Flicks happen so fast, in fact, that it is virtually impossible for a judge to determine the exact order in which events occur, especially at the beginning of the flick. There are no criteria, therefore, for seeing nose and wing movement initiated at the same time as with the other autorotation family, Spins.

The judge must see two things to determine that a flick roll has occurred. The nose must depart the flight path in the correct direction and autorotation must be initiated. If the judge does not observe both events, the figure must be given a zero (0).

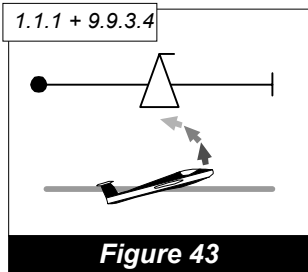

For a positive flick roll, the nose must move away clearly and unambiguously from the wheels. (Figure 43) This puts the aircraft's wings near the critical angle-of-attack. Either shortly after the nose moves, or simultaneously with the nose movement, the aircraft must be seen to yaw around its vertical axis, thus initiating a stall of one wing and subsequent autorotation. If any movement about the longitudinal (roll) axis is observed before the autorotation starts, the figure is downgraded one (1) point per five (5) degrees of roll.

Throughout the flick roll, the main axis of the flick roll's rotation must be in the correct plane and direction of flight. However, the type of motion (angle-of-attack and angular velocity) displayed around the main axis of autorotation differs between aircraft types (much as each type of aircraft has different spin characteristics). If the character of the flick roll changes during the figure, the figure is downgraded. (see Family 9.1) A changing rate of rotation or the nose moving more onto the flight path (like a slow roll) is the most often observed change in character. But for all aircraft types, the criteria for stopping the flick roll is the same: the attitude before starting the flick roll and in the instant of stopping it must be identical and must correspond to the geometry of the basic figure on which the flick roll is performed.

Flick rolls must be observed very carefully to ensure that the competitor is not "aileroning" the aircraft around its longitudinal axis. Aerobatic aircraft with very high rates of roll can occasionally fool a judge in the execution of flick rolls. The movement of the aircraft's nose departing the flight path prior to autorotation is a good clue to the proper execution of a flick roll. As always, the competitor is given the benefit of the doubt, but if a judge is certain that a proper flick roll has not been executed, a zero (0) is given. Another common error is for the aircraft to autorotate, but to not stay in autorotation until the end of the figure. In this case, a deduction of one (1) point for each five (5) degrees of rotation remaining when the autorotation stops must be made. If autorotation ends with more than 45 degrees of rotation remaining, even if the roll is completed with aileron, the flick roll is zeroed.

Family 9.10 – Negative Flick Rolls

For negative flick rolls, all criteria stated for positive flick rolls apply except, of course, that the aircraft is in a negative rather than positive of-attack during autorotation.

Therefore, in a negative flick roll the nose of the aircraft will move toward the wheels as it departs the line of the aircraft's flight path. (Figure 44) This direction of motion must be observed very carefully, it is the defining characteristic that differentiates a negative flick roll a positive flick roll. As with positive flick rolls, if the nose does not in the correct direction, it is not a negative flick roll and the figure must be given a zero (0).

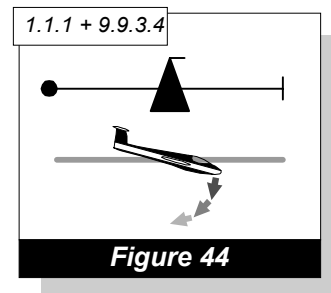

angle-

since
from
move

Family 9.11 and 9.12 – Spins

Spin elements may be combined with any Family 1 or Family 8 figure which begins on a vertical downline. Rolls may follow a spin on the same line.

All spins start from horizontal flight. In order to spin, the aircraft must be completely stalled on a clearly visible horizontal line near its minimum airspeed. There must be no visible pitchup before entering the spin.

When the aircraft enters the spin, its center of gravity should from the beginning travel along a steep, nearly vertical flightpath. This flightpath must be established not later than after one half rotation, otherwise the spin entry is considered a positive or negative flick and the spin must be marked zero (0).

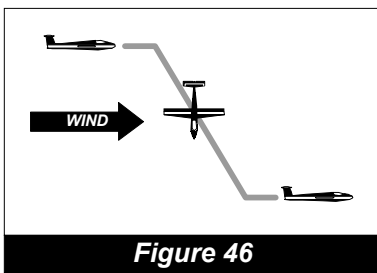

Figure 46

Effect of wind and forward inertia on flight path during one turn spin (effect exaggerated)

During spin entry and in the spin, the flightpath is affected by wind. When the spin is entered with a tailwind, the flightpath may suggest that the spin entry was "forced". This change in appearance is not a marking criterion. (Fig. 46)

Normal Spins (upright spins entered from upright flight and inverted spins entered from inverted flight): When the aircraft stalls, the nose will drop and autorotation starts nearly simultaneously around the longitudinal and vertical axes. If autorotation around the vertical axis is visibly delayed in relation to the autorotation around the longitudinal axis, entry airspeed

was too high, the aircraft was "flicked" into the spin, and the figure must be marked zero (0).

After completion of the prescribed number of turns, the aircraft must stop rotating precisely on the pre-stated heading, then a 90 degree down, wings-level attitude must be seen. Marking criteria for the basic figure being flown then resumes. If a roll follows a spin, there should be a brief, but perceptible pause (similar to unlinked rolls) between the spin and the roll. Because there is no vertical line before the spin, there is no criteria to center either a spin element alone or a spin-roll combination on the vertical downline.

Be alert for early stopping of the stalled autorotation followed by "aileroning" to the pre-stated heading. In this case, a deduction of one (1) point for every five (5) degrees of "aileroning" must be applied. For example, in a one-turn spin the autorotation is observed to stop after 345 degrees of rotation and the ailerons are used to complete the rotation. The highest score this spin could receive is a 7.0. The same obviously applies for over-rotating and correcting back to the prescribed heading.

No account is to be taken of the pitch attitude of the aircraft during autorotation, as some aircraft spin in a nearly vertical pitch attitude while others spin quite flat in conventional spins. Speed of rotation is also not a judging criterion. If the aircraft never stalls, it is apparent that it cannot spin, and a zero (0) must be given. You will see "simulated" spins where barrel rolls or flick rolls are offered as spin entries. In both cases, the flight path will not be downward. In all of these cases, the figure will be zeroed.

In all spins the marking criteria are:

1. A clean breaking stall in horizontal flight.
2. Fully-stalled autorotation.
3. Stopping on pre-stated heading.
4. 90 degrees down, wings-level attitude after stopping on heading.



POSITIONING

Positioning is marked in one of two ways: mechanically, by means of a tracking device, or by the individual judges. When it is marked by a judge, a lower K factor is applied.

Positioning refers to the placement of the figures in relation to the X and Y axes. A sequence should be flown within the aerobatic zone so that the individual figures are symmetrically placed in relation to the X and Y axes.

For each mis-positioned figure, the positioning mark will be reduced by 0.5 point.

HARMONY

(See CIVA Regulations, Part 2, paragraph 2.1.6)

The harmony of a glider program is judged on the following criteria:

- Energy management,
- Figure separation,
- Figure spacing,
- Even intervals between figures.

The "engine" of an aerobatic glider is potential energy. For any aerobatic program, the glider pilot must convert height into speed and back, the more efficiently this is done, the more harmonious the program will look. "Rough" flying with "square corners" instead of reasonably sized part-loops between lines wastes energy and violates the principle of harmony.

The entry airspeed for the next figure must be established upon exiting the preceding figure. Typically, the harmony of a program is disturbed when a competitor uses the lines between figures to gain or dissipate airspeed. Whilst an inclination of these lines greater than +0 / -10 degrees will be downgraded by 1 point per 5 degrees in the marks for the individual figures, there must also be a deduction from the harmony mark.

Clear and even spacing of figures is another important criterion for the harmony mark. Omitting the horizontal lines between figures is penalized by deductions from the marks for the individual figures. But since this also disturbs the harmony of a program, deductions from the harmony mark must also be made. Showing lines of greatly varying lengths between figures must also be reflected by a reduced harmony mark.

There will be no deductions from the harmony mark when competitors must gain or dissipate airspeed between figures due to unharmonious construction of a compulsory program.

The same applies when a competitor is forced to insert longer gliding passages between figures due to strong headwind.

For each occurrence where the harmony of the program is disturbed, a 0.5 point deduction is made to the harmony mark. Furthermore, each figure marked zero (0) reduces the harmony mark by one (1) point.



APPENDIX 2 TO CIVA REGULATIONS

Calculation of scores for an aerobatic programme using the Tarasov-Bauer-Long-Penteado method (TBLP) in a figure by figure mode.

The rating of a pilot performance for a given flight is an amount of points arising from two separate sources:

A) Quality evaluation of flown figures or flight positioning with a score given by judges observing the flight, on a scale ranging from 0 to 10.

B) Penalties arising from height or time infringements and/or interruptions of the program sequence and other disciplinary actions.

The scores from (A) are subject to random and systematic errors due to the inevitable lack of exactness of judging, and the Purpose of the TBLP system is to reduce the effect of those errors to a minimum. The penalties from (B) are not subject to the same errors and are simply subtracted from the scores results (A) after they have been calculated as described below. The calculation of scores is performed in 2 separate phases:

PHASE I

Scores assigned to individual figures on each flight are statistically treated to remove coarse deviations from a calculated expectation range. This range is centered at 1.4 times the individual pilot-figure Standard Deviation and the removal is performed in a continuous weighted fashion from 1.2 SD (no removal) to 1.6 SD (full removal). The score is either taken with its original value or slowly changed to a value that represents the average of the scores of the other judges.

Pilots or Judges with all scores equal zero will be considered as non-existent for calculation purposes.

Let:

- $G(p,j,f)$ = Figure Grade given to the p^{th} pilot, f^{th} figure by the j^{th} judge.
- N_p = Total number of pilots in the flight with at least one figure score bigger than zero.
- N_j = Total number of judges on the panel with at least one figure score bigger than zero.
- $N_f(p)$ = Total number of figures for the p^{th} pilot.
- $R_g(p,j)$ = Raw grade for the p^{th} pilot, j^{th} judge.
- $G_a(p,j)$ = Grade average for the p^{th} pilot, j^{th} judge.
- $J_a(j)$ = Average of Raw grades given by the j^{th} judge.
- $J_s(j)$ = The mean-square difference between Raw grades given by the j^{th} judge and his average $J_a(j)$.
- A = The average of all Raw grades given by all judges.
- S = The mean square difference between all Raw grades and the average A .
- $A_{cf}(j)$ = Average correction factor for the j^{th} judge.
- $S_{cf}(j)$ = Scatter correction factor for the j^{th} judge.
- $N_g(p,j,f)$ = Rescaled grade corrected to each p^{th} pilot, j^{th} judge and f^{th} figure.
- $F_a(p,f)$ = Pilot averages on each figure (for all judges).
- $F_s(p,f)$ = Pilot scatters on each figure
- $F_{ssd}(p,f)$ = Pilot Standard Deviation on each figure ($\text{Sqrt } F_s(p,f)$).
- $F_d(p,f)$ = Figure displacement in Standard Deviation units.
- $F_k(p,j,f)$ = Figure progressive deletion limit in Standard Deviation units. This is the external size of the acceptance window for grade displacements.
- $F_{wm}(p,j,f)$ = Figure weighted average multiplier (0 to 1).
- $F_t(p,f)$ = Corrected figure grade.
- $R(p,j)$ = Corrected raw score. Sum of corrected figure grades multiplied by respective K factors.



Task 1.

Rescale the original figure grades to minimize errors arising from differences in judging style.

1. Compute the raw grade for the pth pilot and jth judge

$$Rg(p, j) = \sum_{f=1}^{Nf(p)} G(p, j, f)$$

This produces a matrix of grades - the total grade given to all of the figures flown by a particular pilot by each judge. It is the sum of all the figure grades given to a particular pilot by each judge. So each pilot has a total grade for each judge

2. Compute the Grade average for that pth pilot and jth judge.

$$Ga(p, j) = \frac{1}{Nf(p)} Rg(p, j)$$

This calculations simply converts the total grades calculated in Stage 1 into average grades, by dividing by the number of figures flown by each pilot.

3. Compute the jth judge average.

$$Ja(j) = \frac{1}{Np} \sum_{p=1}^{Np} Rg(p, j)$$

This is the average TOTAL GRADE given by each judge across all of the pilots and all of the figures.
Judges that generally give low grades will have lower total grades.

Judges that generally give higher grades will have higher total grades.

So this calculation starts to give us some idea of how differently the judges are grading the pilots.

4. Compute the jth judge mean-square scatter.

$$Js(j) = \frac{1}{(Np - 1)} \left[\sum_{p=1}^{Np} Rg(p, j)^2 - Ja(j)^2 \right]$$

This calculates the VARIANCE in each judges grades – that is the scatter in the grades given by a particular judge across all of the pilots judged. For each judge, we calculate his/her average grade and then look to see how far each individual

pilots grade differs from this judges average. We are looking at how a particular judge grades the whole sequence flown by a particular pilot. We are not dealing with differences in how individual figures are graded at this stage of the analysis.

5. Compute the flight average.

$$A = \frac{1}{Nj} \sum_{j=1}^{Nj} Ja(j)$$

This is the average grade (total grades given for all figures in the sequence) given across all pilots and all judges. You can also calculate this from the raw by totaling all the grades and then dividing by the number of pilots and then by the number of judges.

6. Compute the flight mean-square scatter.

$$S = \frac{1}{(NpNj) - 1} \left[\sum_{j=1}^{Nj} \left\{ \sum_{p=1}^{Np} Rg(p, j)^2 \right\} - A^2 \right]$$

This is similar to Step 4. Here we are calculating the flight VARIANCE – that is the variation (scatter) in the sequence grades given by each judge to each pilot – but we are looking at the variance across all of the judges and all of the pilots.

7. Compute the average correction factor.

$$Acf(j) = \frac{A}{Ja(j)}$$

The Average Correction factor is used to correct differences in style of judging. Two judges might grade 10 pilots in the same rank order, but one might give high grades, the other lower grades. We “adjust” each judge’s grades in a way that eliminates differences in style of judging. The average correction factor tells us how much each judges grades need to be increased or decreased to correct for differences in judging style.



8. Compute the Scatter correction factor.

$$Scf(j) = \frac{\sqrt{S}}{\sqrt{Js(j)}}$$

This makes sure that all of the judges assess the pilots using the same range of grades. Judges who showed large scatter in the sequence grades they gave to the pilots will have the range of their grades narrowed, and vice versa. The figures in this calculation are square rooted to convert the scatter measures into units of STANDARD DEVIATIONS.

9. Compute the rescaled figures grades.

$$Ng(p, j, f) = \{[G(p, j, f) - Ga(p, j)]Scf(j)\} + [Ga(p, j)Acf(j)]$$

Rescaled grades for all figures - all judges now have similar averages and scatters (A and S).

This completes Task 1. We have corrected for different styles of judging.

Task 2. Look for bias in the judges' grades and progressively discount figure grades considered unrepresentative.

The rescaled figure grades are now weighted and progressively adjusted before being transformed into a raw score for the pth pilot and jth judge. This procedure removes individual figure grades that are presumed to be unrepresentative of the pilot's performance. Until now we have been looking at sequence grades (sum of all figure grades for a particular pilot). We will now start to look at patterns in grades on a figure by figure basis.

10. Compute the pth pilot, fth figure Rescaled Grades average of all judges.

$$Fa(p, f) = \frac{1}{N_j} \sum_{j=1}^{N_j} Ng(p, j, f)$$

This is the average figure grade given to a particular pilot for a particular figure across all judges. Calculate an average for all figures and all pilots. Fa(p,f) is the estimated mean value of the hypothetical Gaussian population from which the Grades were drawn.

11. Compute the pth pilot, fth figure mean square scatter.

$$Fs(p, f) = \frac{1}{N_j - 1} \left[\sum_{j=1}^{N_j} Ng(p, j, f)^2 - Fa(p, f)^2 \right]$$

This calculates, for every figure flown, the variance of the figure grades given by the judges. It shows the level of scatter in the grades given to each figure by the judges. We need to know how scattered the grades are so that we can say if any of the grades given for a particular figure are "unrepresentative" of the pilots performance.

12. Compute the pth pilot, fth figure Standard Deviation.

$$Fssd(p, f) = \sqrt{Fs(p, f)}$$

This converts the figure Mean Scatter from a VARIANCE to a STANDARD DEVIATION. Then there has to be a logic step to eliminate zero results. If Fssd < 0.03Fa(p,f) then, Fssd(p,f) = 0.03Fa(p,f)

13. Compute the pth pilot, jth judge, fth figure, displacement in units of Fssd(p,f).

$$Fd(p, j, f) = \frac{Abs[Ng(p, j, f) - Fa(p, f)]}{Fssd(p, f)}$$

This step calculates a "statistical" measure of how "representative" the grade given by one judge for a particular figure for a particular pilot, is of the grades given by all judges for that figure.

We calculate the figure displacement in this way so that it is comparable against statistical norms that help us to decide how confident we are that each individual figure grade is representative.



The size of this displacement is a measure of the probability that a grade is representative. If it is less than 1.2 the grade is accepted. Between 1.2 and 1.6 the grade is progressively re-scaled toward the Flight Average for the figure. From 1.6 upwards, the Flight Average is used instead of the grade given. The 1.6 limit gives close to a 90% confidence level that discarded grades are actually non-representative.

14. Compute the maximum window acceptance values expressed in units of Fssd(p,f).
 If the result is less than zero, then make it equal to zero.

$$Fk(p, j, f) = 1.6 - Fd(p, j, f)$$

15. Compute the Weighted average multiplier in values expressed in units of Fssd(p,f).
 If the result is greater than 1, then make it equal to 1.

$$Fwm(p, j, f) = \frac{Fk(p, j, f)}{0.4}$$

This calculation and logic check creates a flag that contains the weighting factor to be applied to each figure grade – the weighting factor depends on how representative the grade is compared to the grades given for the same figure by the other judges.

The logic of this calculation is correct – but it is not obvious how this equation has arisen. The following table should illustrate how the logic works for each figure!

Fd - Figure Displacement	Fk 1.6 - Fd(p,j,f)	If Fk(p,j,f) < 0, then it = 0	Fwm - Weight multiplier	Fwm cannot be greater than 1	Overall Result
1.00	0.60	0.60	1.500	1.000	Accepted
1.21	0.39	0.39	0.975	0.975	Progressively rescaled
1.40	0.20	0.21	0.500	0.500	
1.59	0.01	0.01	0.025	0.025	
1.80	-0.2	0.00	0.000	0.000	Rejected

16. Compute the corrected final figure value

$$Ft(p, j, f) = [G(p, j, f) - Fa(p, f)Fwm(p, j, f)] + Fa(p, f)$$

17. Compute the corrected raw score for the pth pilot and jth judge, to be used in the next phase.

$$R(p, j) = \sum_{f=1}^{Nf(p)} [Ft(p, j, f)Kf(p, f)]$$

This introduces the K factor (difficulty coefficient) into the calculation. Each of the corrected figure grades (Ft(p,j,f)) are multiplied by the appropriate K factor.

PHASE II

The calculated corrected raw scores are now used in a second computation. The term raw score now, refers to the corrected raw scores R(p,j) obtained with the previous calculations. Again, pilots or judges with all raw scores equal zero will be considered as non-existent for calculation purposes.

Let:

- R(p,j) = Raw score calculated for the pth pilot and the jth judge.
- Np = Total number of pilots flying the program with at least one raw score bigger than zero.
- Nj = Total number of judges on the panel with at least one raw score bigger than zero.
- Ja(j) = Judge average: the average raw score given by the jth judge.
- Js(j) = Judge scatter: the mean-square difference between raw scores given by the jth judge and



- his average score $Ja(j)$.
- A = Overall average: the average of all raw scores given by the panel of judges in that flight.
 - S = Overall scatter: the mean square difference between all raw scores and the average A.
 - $N(p,j)$ = Rescaled score corrected to each p^{th} pilot and j^{th} judge.
 - $Pa(p)$ = Pilot average: the p^{th} pilot average rescaled score.
 - $Ps(p)$ = Pilot scatter: the mean-square difference between the p -th pilot rescaled scores $N(p,j)$ and their averages $Pa(p)$.
 - $Psd(p)$ = Pilot Standard Deviation $\text{Sqrt } Ps(p)$.
 - $D(p,j)$ = Displacement of the j^{th} judge rescaled score from $Pa(p)$ in units of Standard Deviation $\text{Sqrt } Ps(p)$.
 - $K(p,j)$ = Progressive deletion limit in standard deviation units. This is the external size of the acceptance window for score displacements.
 - $Wm(p,j)$ = Weight average multiplier factor for each judge in a pilot (varies from 0 to 1).
 - $Wd(p)$ = Total weight average sum for all judges scores on the p^{th} pilot.
 - $T(p)$ = Final TBLP average score for the p^{th} pilot.

Task 1. Rescale the raw scores in order to minimize errors arising from differences in judging style.

The notes for this section are shorter since most of the process is a repeat of Phase 1, Task 1.

18. Compute the j^{th} judge average raw score.

$$Ja(j) = \frac{1}{Np} \sum_{p=1}^{Np} R(p, j) \quad \text{The raw scores are used to calculate the average total score given across all pilots (and all figures) by each judge.}$$

19. Compute the j -th judge mean-square raw score scatter.

$$Js(j) = \frac{1}{(Np - 1)} \sum_{p=1}^{Np} [R(p, j)^2 - Ja(j)^2] \quad \text{Here we are calculating the variance in each judges scores across all of the pilots and figures.}$$

20. Compute the overall event average.

$$A = \frac{1}{Nj} \sum_{j=1}^{Nj} Ja(j) \quad \text{Simply the overall judge average.}$$

21. Compute the overall event scatter.

$$S = \frac{1}{((NpNj) - 1)} \left[\sum_{j=1}^{Nj} \left(\sum_{p=1}^{Np} R(p, j)^2 \right) - A^2 \right] \quad \text{This gives the overall variance (scatter) for the event. It's the same calculation as for the other variances!}$$

22. Compute the rescaled scores.

$$N(p, j) = \left[\left\{ \frac{R(p, j) - Ja(j)}{\sqrt{Js(j)}} \right\} \sqrt{S} \right] + A \quad \text{Rescaled scores for all judges now have the same average and scatter (A and S).}$$

This completes Task 1. We have corrected for different styles of judging.



Task 2. Look for bias in the judges' grades and progressively discount figure grades considered unrepresentative.

23. Compute the pilot average rescaled score.

$$Pa(p) = \frac{1}{N_j} \sum_{j=1}^{N_j} N(p, j)$$

This gives the average rescaled score for each pilot across all judges and figures. Pa(p) is the estimated mean value of the hypothetical Gaussian population from which the scores were drawn.

24. Compute the pilot mean-square scatter.

$$Ps(p) = \frac{1}{(N_j - 1)} \left[\sum_{j=1}^{N_j} N(p, j)^2 - Pa(p)^2 \right]$$

This gives the rescaled variance for each pilot across all judges and figures.

25. Compute the pilot Standard Deviation

Set to a minimum of 0.3Pa(p) to eliminate zero values.

$$Psd(p) = \sqrt{Ps(p)}$$

Again, simply converts the variance to a standard deviation. If Psd(p) < 0.03Pa(p) then, Psd(p) = 0.03Pa(p).

26. Compute the judges scores displacements in units of pilot Standard Deviation.

$$D(p, j) = \frac{Abs[N(p, j) - Pa(p)]}{Psd(p)}$$

27. Compute the maximum window acceptance values in units of pilot standard deviation.

If it is less than zero, set it to zero.

$$K(p, j) = 1.6 - D(p, j)$$

Same logic as in Phase 1. If K(p,j) < 0 then, K(p,j) = 0.

28. Compute the average weight multiplier for the judges.

If it is greater than 1, then set it equal to 1.

$$Wm(p, j) = \frac{K(p, j)}{0.4}$$

Same logic as in Phase 1. If Wm(p,j) > 1 then, Wm(p,j) = 1.

29. Compute the total average weight for all judges on each pilot.

$$Wd(p) = \sum_{j=1}^{N_j} Wm(p, j)$$

30. Compute the final TBLP scores.

$$T(p) = \frac{1}{Wd(p)} \sum_{j=1}^{N_j} [N(p, j)Wm(p, j)]$$

If T(p) < 0 then, T(p) = 0.

Penalty Points arising from category (B) are then subtracted from the results calculated above. The result is the pilot final score for the flight. If the final score is negative, a zero will be used for that pilot on that flight.

APPENDIX 3 TO C.I.V.A. REGULATIONS (PART TWO)
LIST OF FIGURES FOR PROGRAMMES 2, 4, AND 6

NOTE: Unlinked and opposite rolls are not permitted.

1. LINES & ANGLES

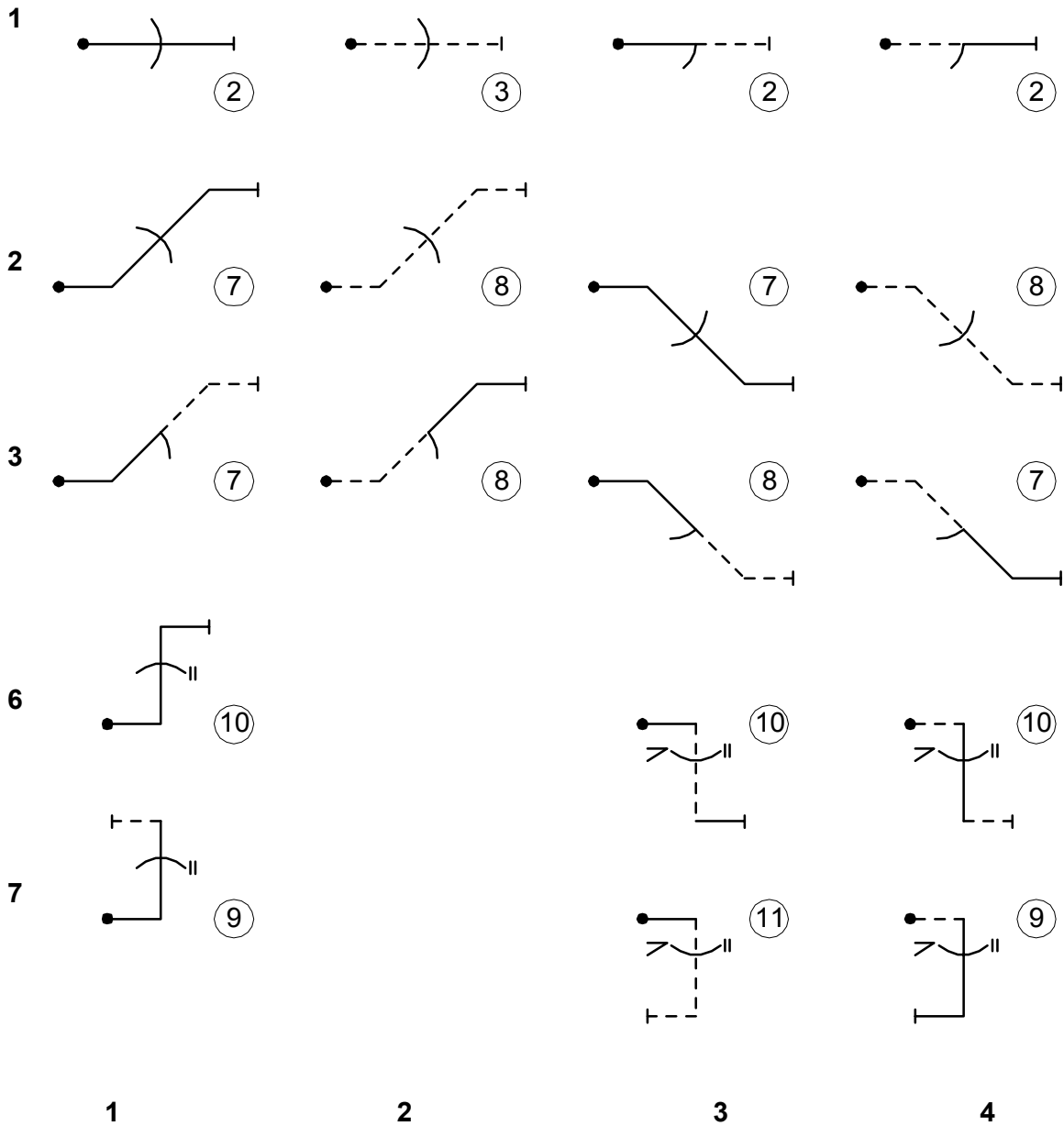



1.

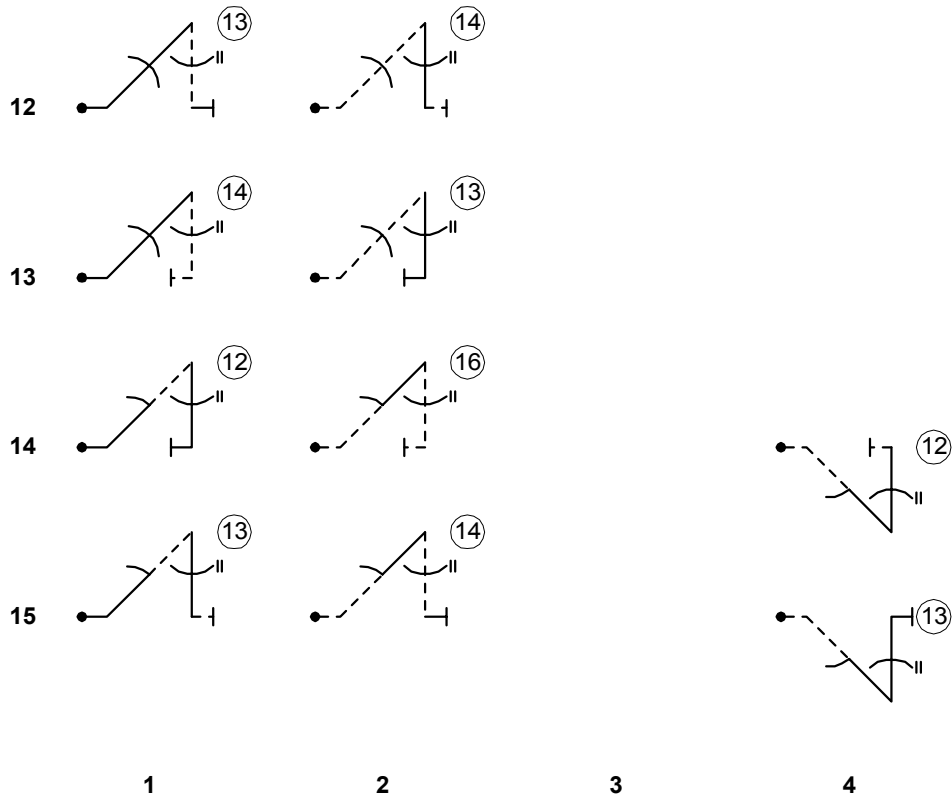

2.

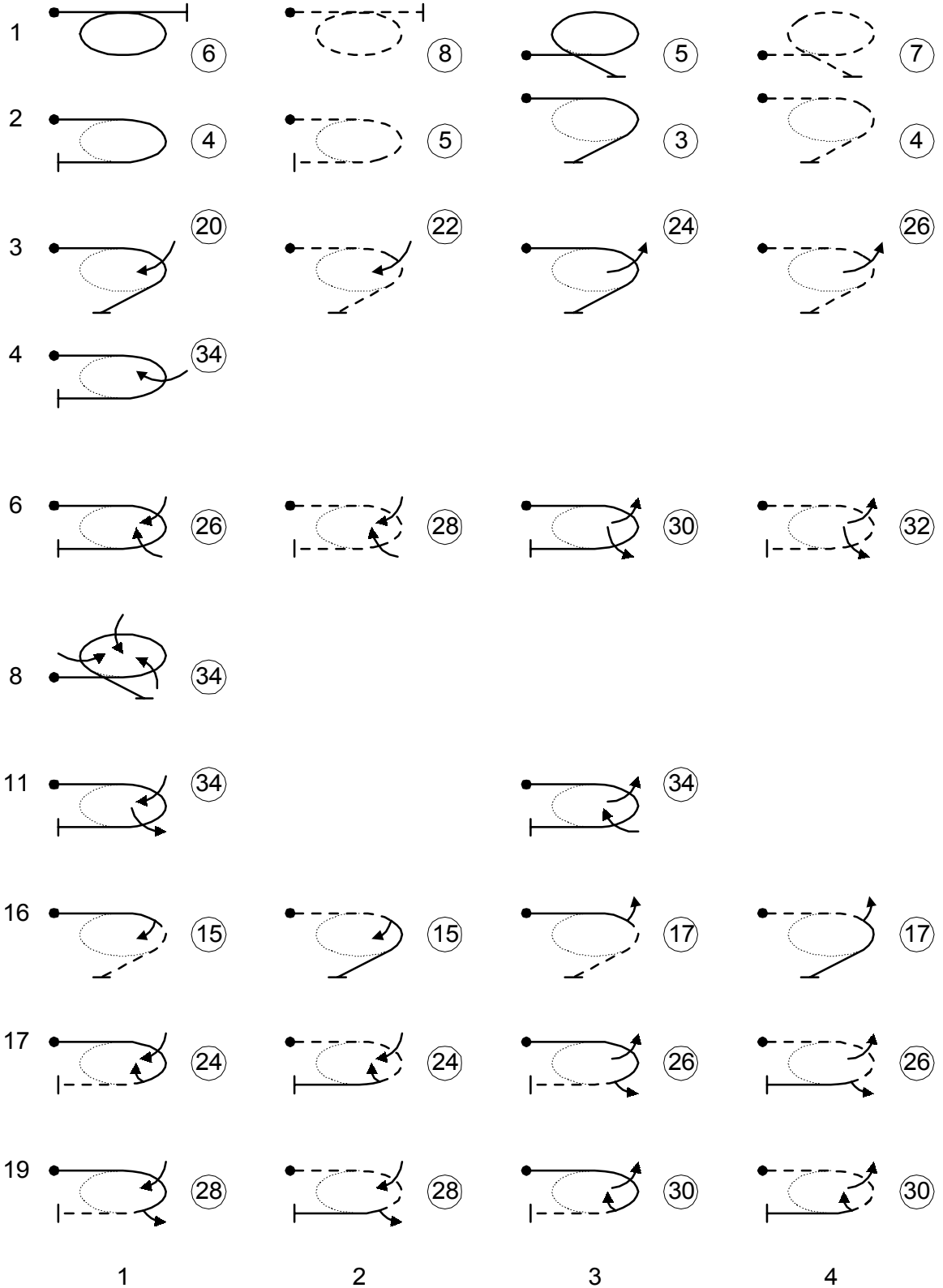

5. STALL TURNS

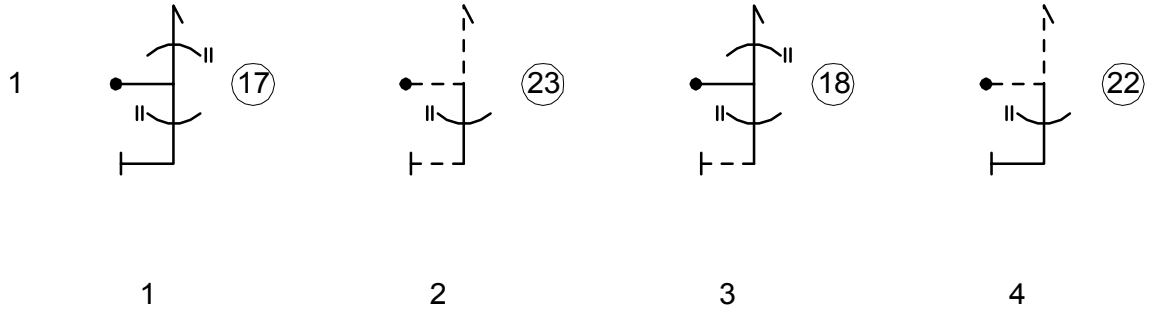

Rolling elements may only be added where indicated.

6. TAIL SLIDES

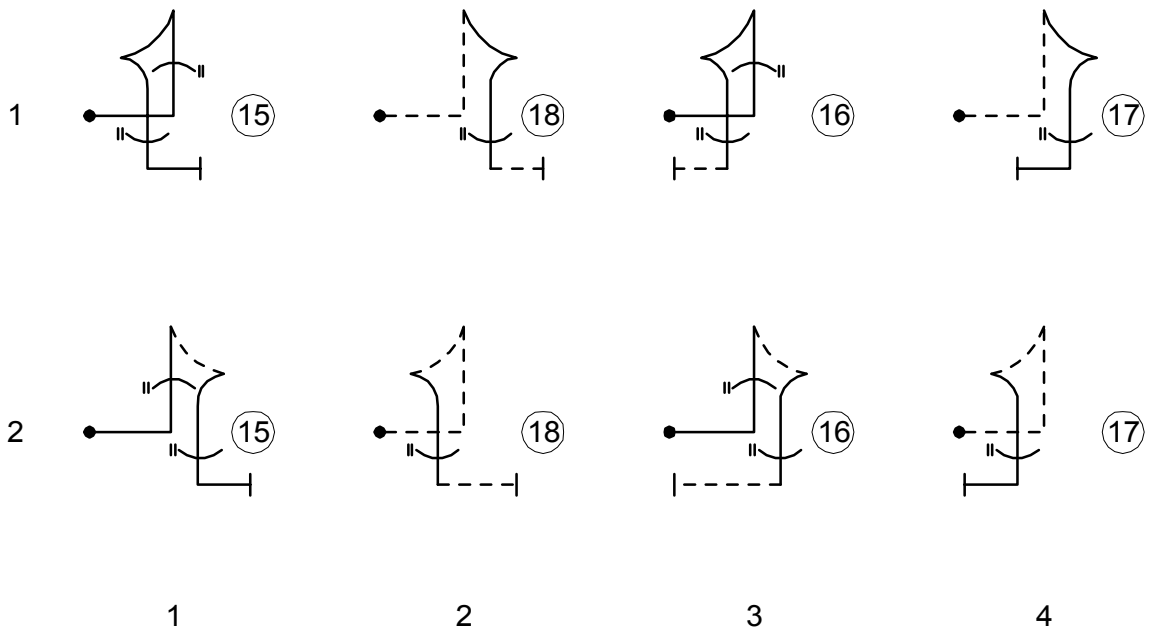

Rolling elements may only be added where indicated.

7. LOOPS AND EIGHTS

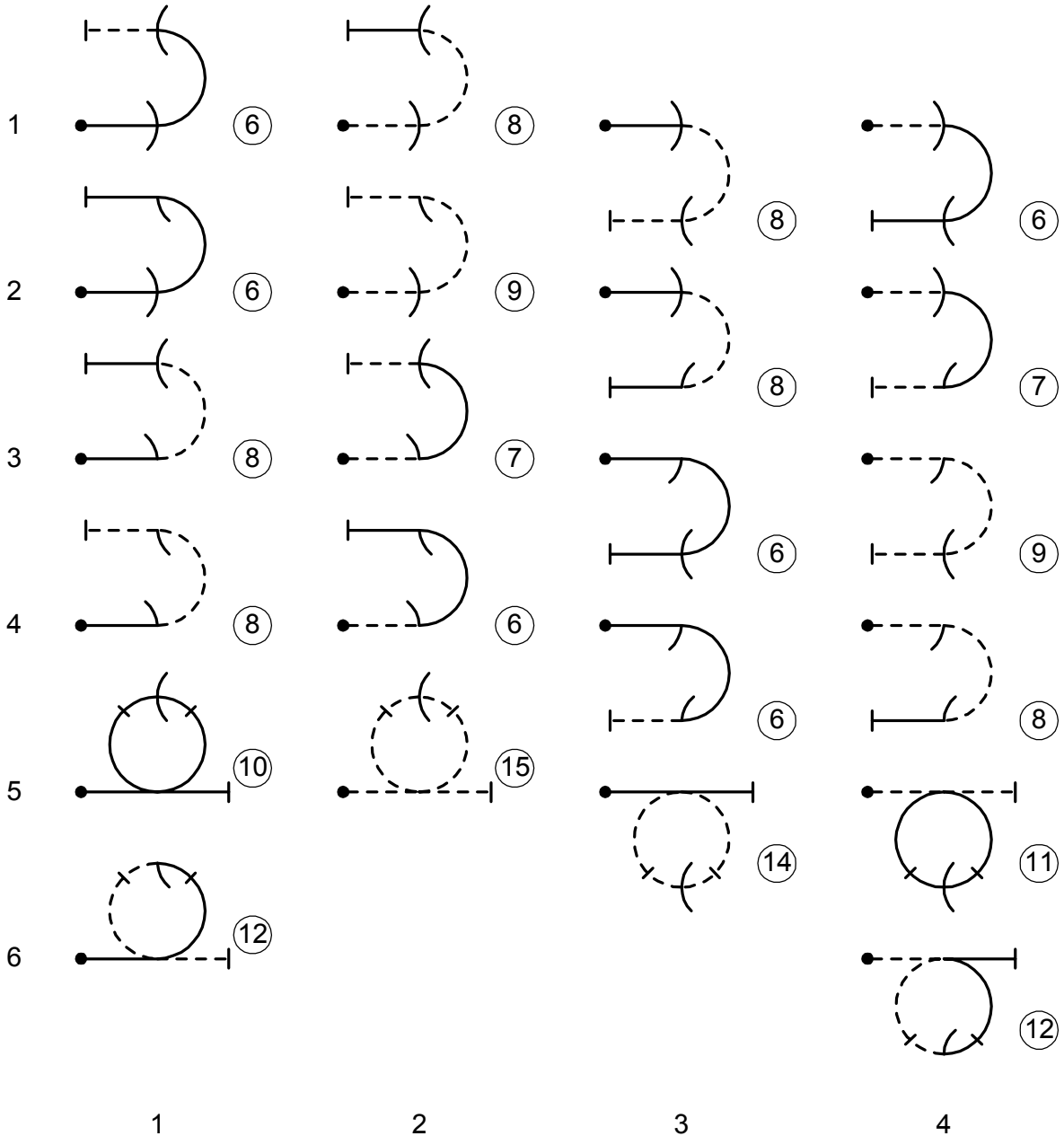

Notes:

Flick rolls are not permitted on the horizontal entry lines of figures in columns 1 and 2, nor in the horizontal exit lines of figures in columns 3 and 4, of 7.1 to 7.4.

Flick rolls are not permitted in figures in columns 3 and 4 of 7.5 or 7.6.



7.

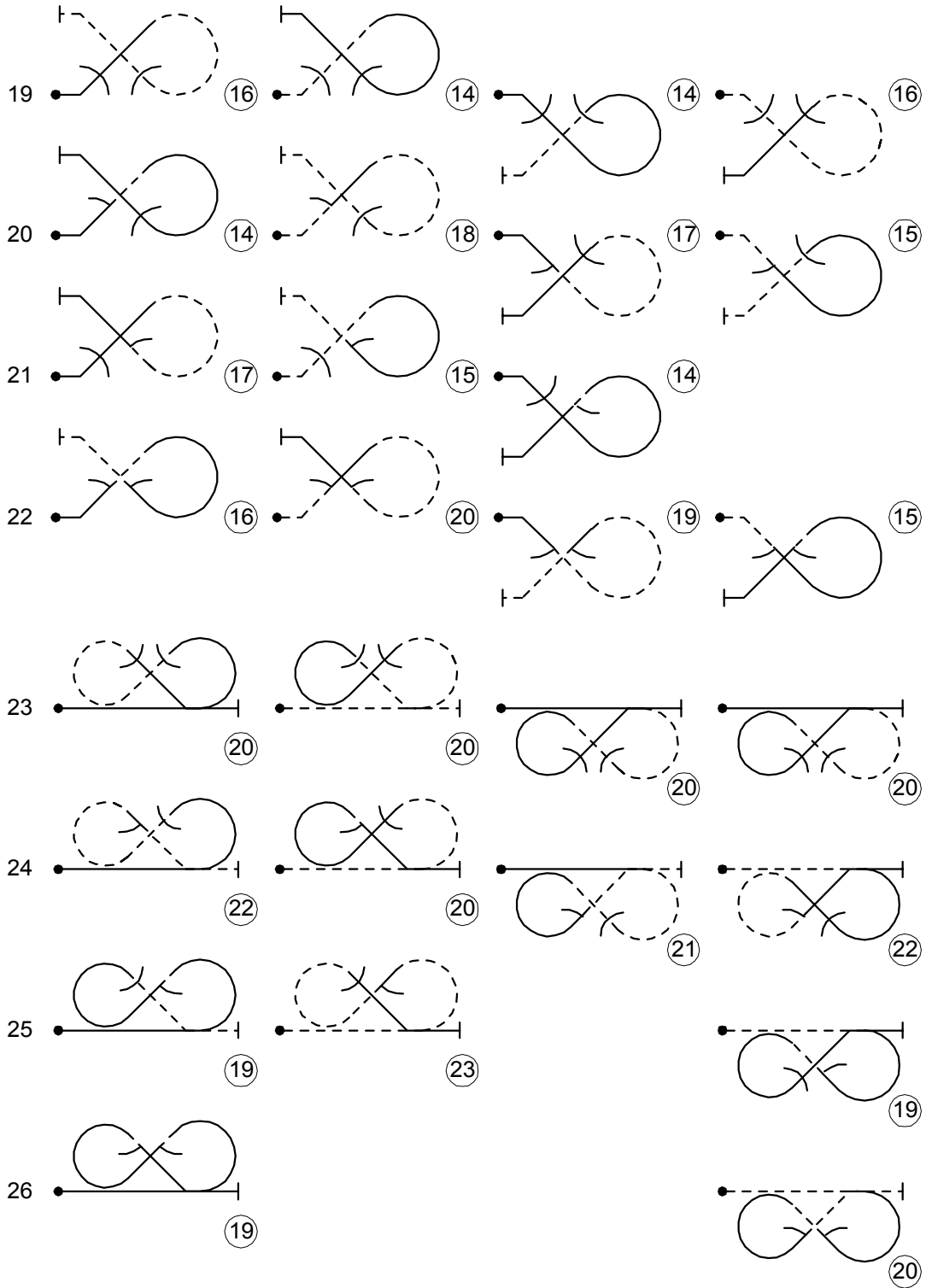

NOTE: At the sign , only half-rolls permitted.

7.

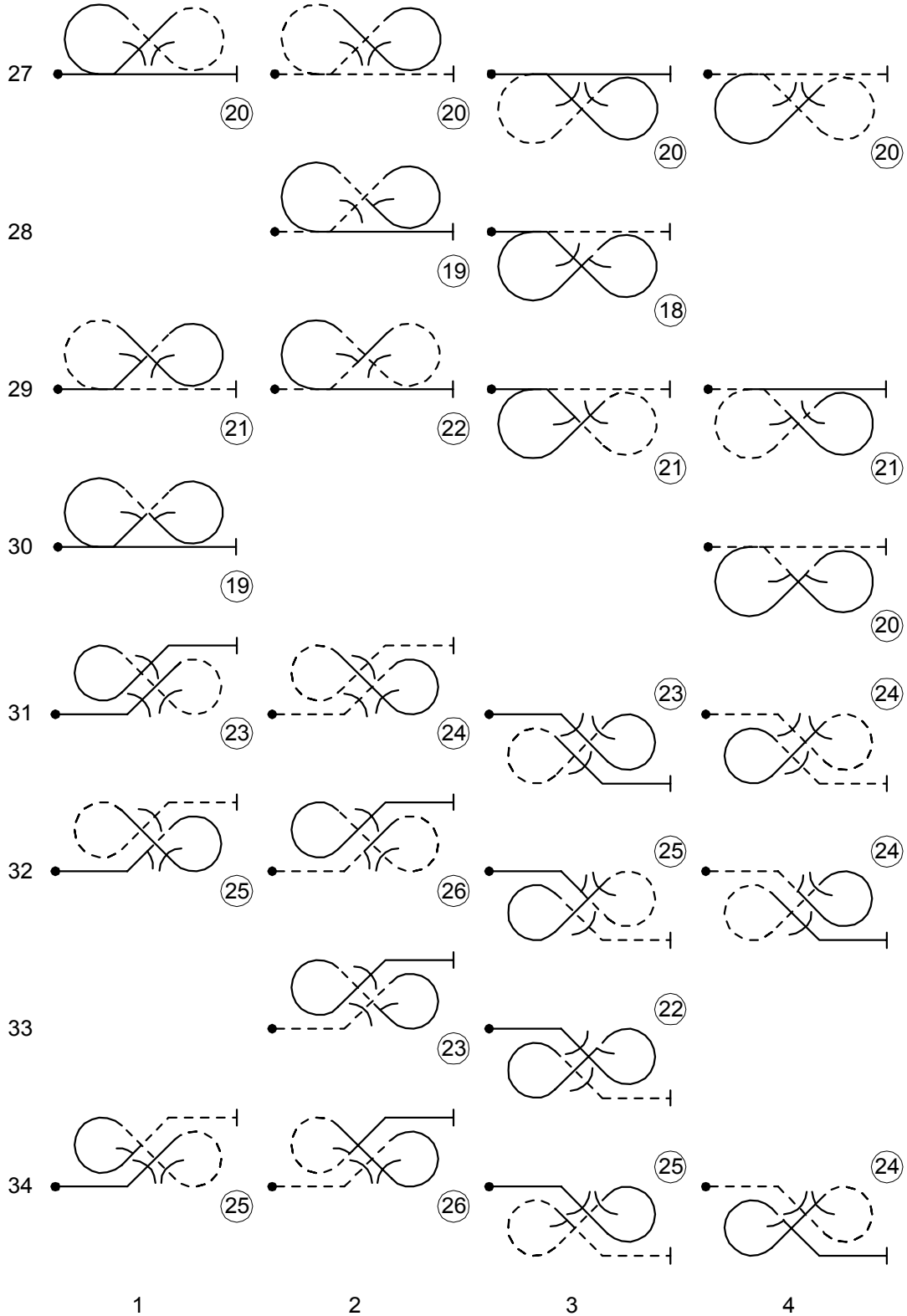

NOTE: At the sign only half-rolls permitted.

7.

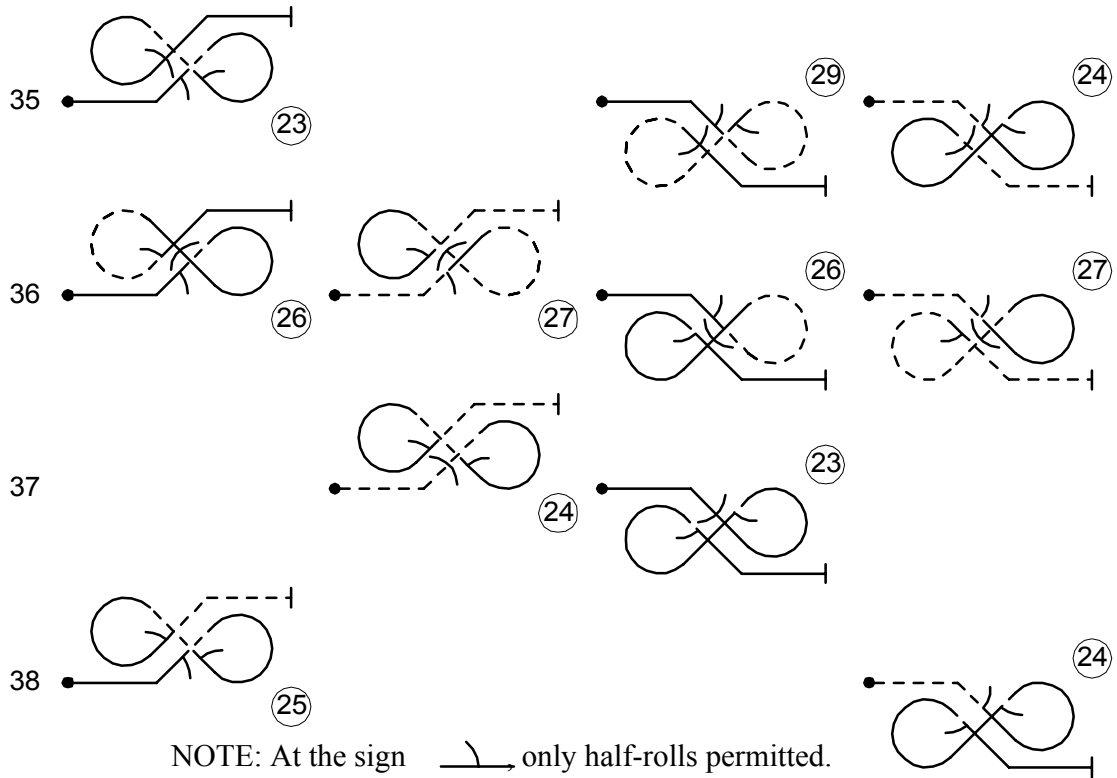

1

2

3

4

8. COMBINATIONS OF LINES, ANGLES AND LOOPS

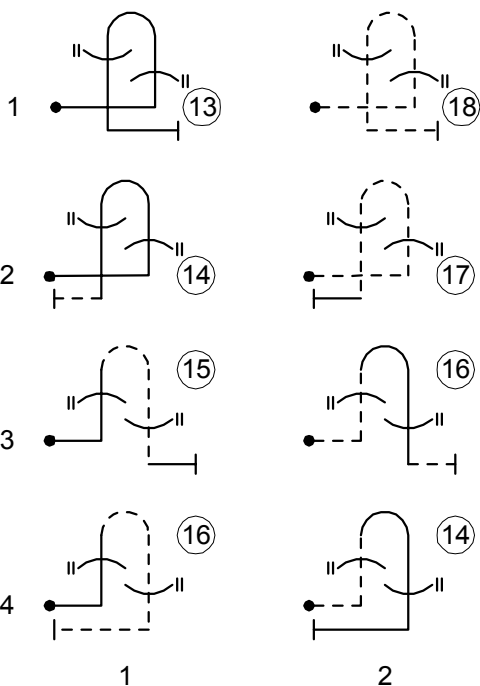

8.

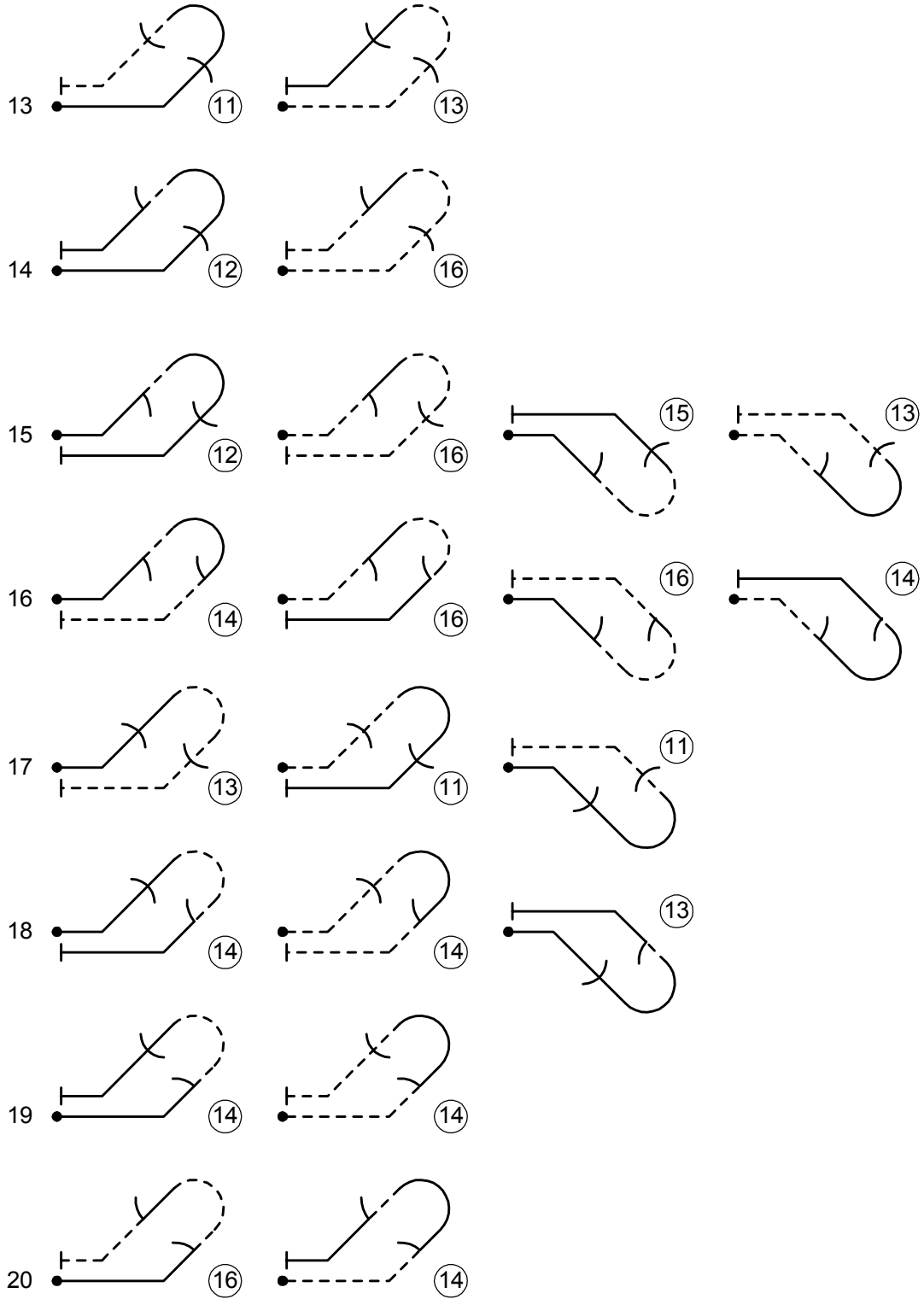

1

2

3

4

8.

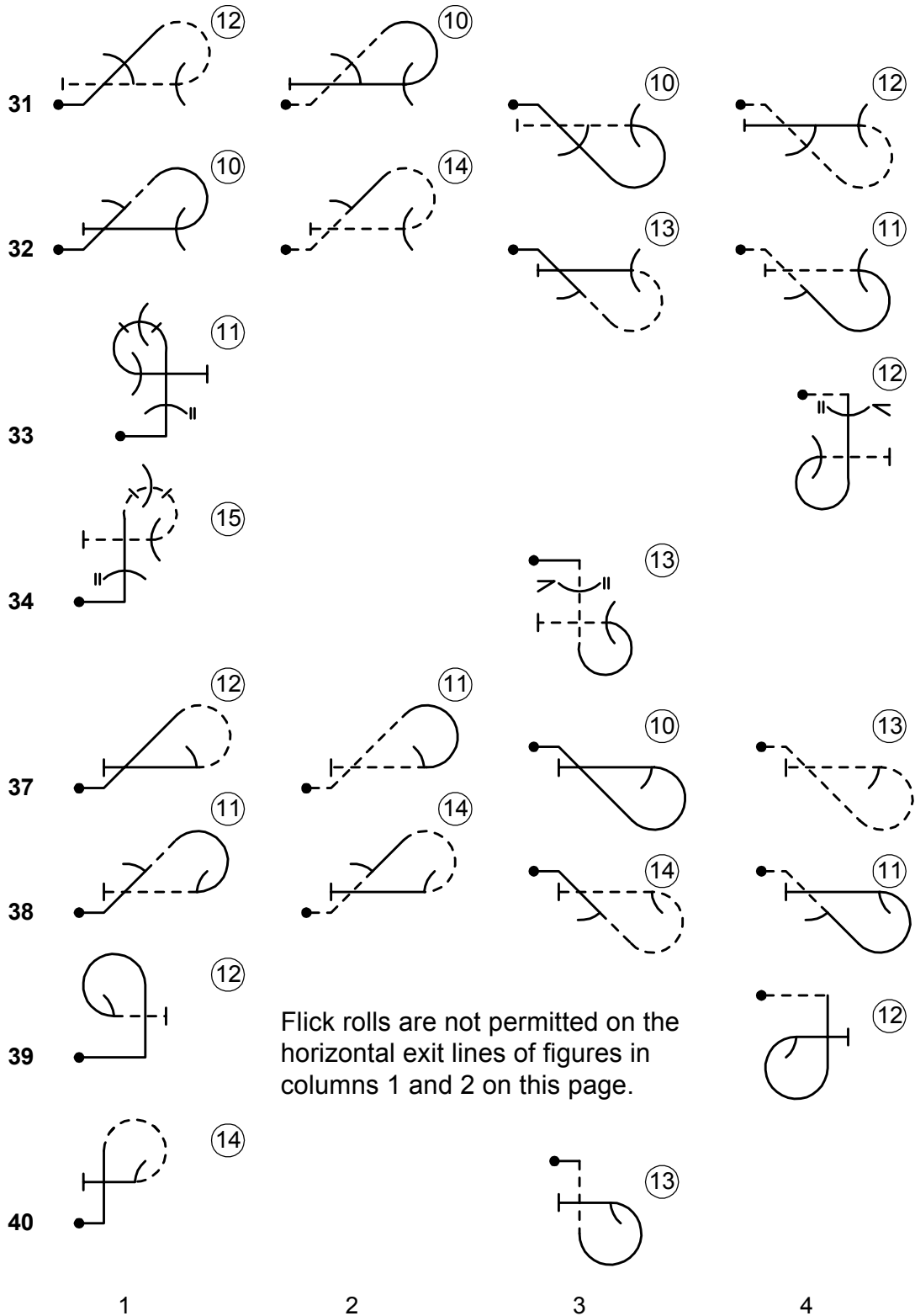

8.

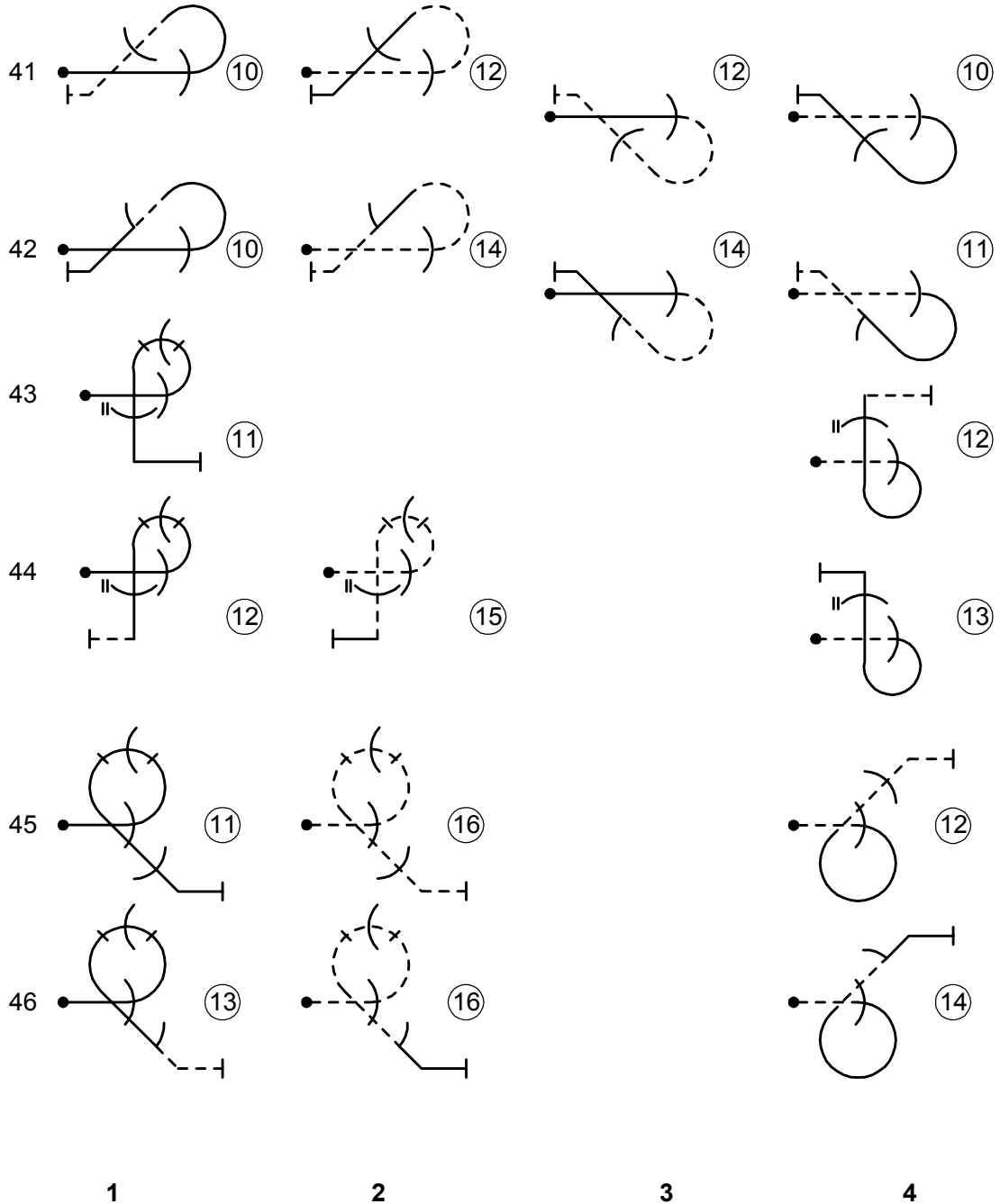

Flick rolls are not permitted on the horizontal entry lines of figures in columns 1 and 2 on this page, nor on vertical down lines of 8.43 or 8.44 after a hesitation roll in the loop.

8.

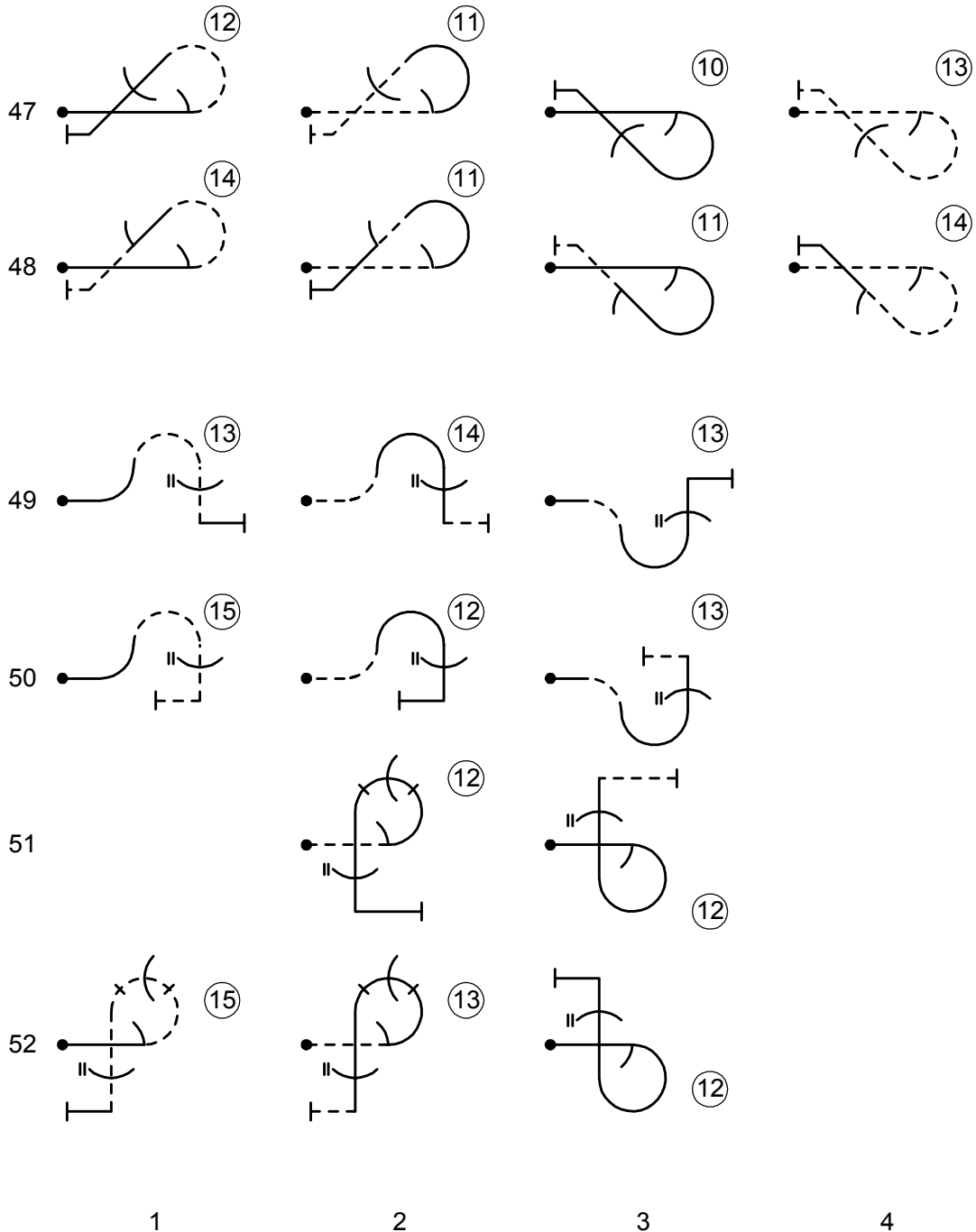

Flick rolls are not permitted on the horizontal entry lines of figures in columns 1 and 2 on this page, nor on vertical down lines of 8.51 or 8.52 after a hesitation roll in the loop.



9. ROLLS AND SPINS

9.1		$\frac{1}{4}$	$\frac{1}{2}$	$\frac{3}{4}$	1	$1\frac{1}{4}$	$1\frac{1}{2}$	$1\frac{3}{4}$	2
1		9							
2			9						
3			6		12		15		18
4			6		12				
5		3	6						
		1	2	3	4	5	6	7	8



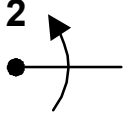

2-POINT ROLLS

9.2					1		1½		2
3	2 				14				
		1	2	3	4	5	6	7	8

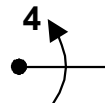

HESITATION ROLLS



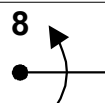

9.4			$\frac{1}{2}$	$\frac{3}{4}$	1	$1\frac{1}{4}$	$1\frac{1}{2}$	$1\frac{3}{4}$	2
2			11						
3			8		17				
4			8						
		1	2	3	4	5	6	7	8

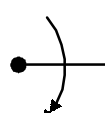



9.8			$\frac{1}{4}$	$\frac{1}{2}$	$\frac{3}{4}$	1	$1\frac{1}{4}$	$1\frac{1}{2}$	$1\frac{3}{4}$	2
3			11							
		1	2	3	4	5	6	7	8	

SUPER SLOW ROLLS

9.13			$\frac{1}{2}$		1		$1\frac{1}{2}$		2
3			8		16				
		1	2	3	4	5	6	7	8

POSITIVE AND NEGATIVE FLICK ROLLS

9.9			½	¾	1	1¼	1½	1¾	2
2			15						
3			12						
4			12		16				
5			12	14	16				
10			12	14	16				
		1	2	3	4	5	6	7	8

9.10			½	¾	1	1¼	1½	1¾	2
2			18						
3			15						
4			15		19				
5			15	17	19				
10			15	17	19				
		1	2	3	4	5	6	7	8



FAMILY 9.11 (POSITIVE SPINS)

			1	1¼	1½	1¾	2	
1		Upright Entry Line			5	6	7	
			4	5	6	7	8	

FAMILY 9.12 (NEGATIVE SPINS) APPENDIX 4 TO CIVA REGULATIONS (PART TWO)

			1	1¼	1½	1¾	2	
1		Inverted Entry Line			7	8	9	
			4	5	6	7	8	



APPENDIX 4 TO CIVA REGULATIONS (PART TWO)

CODE OF PRACTICE FOR THE CHIEF JUDGE AND BOARD OF JUDGES AT WORLD AND CONTINENTAL AEROBATIC CHAMPIONSHIPS

Chief Judge

1. The Chief Judge's primary concern should be the accurate and fair judging of the competition flights, including the monitoring of flights for zero marks and penalties. He should place his expertise at the disposal of the Board of Judges, and coordinate and guide their work.
2. The Chief Judge oversees administrative matters (correctness of paperwork, recording of penalties, etc.) but should be provided with a small group of special assistants who will perform at least the following tasks under his supervision: (i) calling the manoeuvres and recording the notes of the Chief Judge, to whatever extent he requires; (ii) processing and expediting the flow of paperwork; (iii) receiving and recording the calls of the Line Judges; (iv) handling all other radio communications. One of his assistants should assist in monitoring the zero marks and penalties awarded by the Judges after each flight.
3. The Chief Judge should record his marks and comments, as an aide-memoire, on a score sheet which he retains for his own future reference. The official recording of penalties will be on a separate sheet which is later available for the contestant to check.
4. The Chief Judge must hold seminars with the Judges, at least one of which will be with Team Managers or other team representatives present (CIVA 1.1.6.2.). He should give guidance to the Judges as to the current Judging Criteria and rules for judging, on which he should conduct 'question and answer' sessions with the aid of the President of the Judging Sub-Committee.
5. The Chief Judge will hold other routine evaluation meetings with the Judges during the contest (CIVA 1.1.6.2.), and before it begins he must hold practice sessions on the judging line during the contestants' training flights (see 6 below). He should insure that the Code of Practice is understood and operates smoothly, and establish a good working relationship between teams of Judges and Assistants, Timekeepers, and other helpers.
6. The Chief Judge is responsible for ensuring that there is enough time between flights for the judging to be unhurried: he should control (by radio) the flow from one contestant to the next.
7. At the end of each flight, the Chief Judge should ascertain whether any of the Judges has recorded a zero mark or height penalty. A suitable method should be arranged for individual Judges to call such matters to the Chief Judge's attention as soon as the flight ends.
8. In the event of a difference of opinion between the Judges concerning a zero mark or height penalty, the Chief Judge must call for a discussion as soon as possible after it is brought to his attention (CIVA 2.4.8.). The official video shall be available to assist in such discussion (CIVA 2.1.6.) when it concerns a matter of fact, for example the direction of a rolling turn or the omission of a figure or manoeuvre. If the discussion concerns a matter of perception, such as the initiation of a flick roll or spin, then the video shall not be used. Instead, the majority view shall be determined by the grades given by the judges in real time.
9. In case of a vote among the Judges on the question of penalisation, the Judge of the same nationality as the pilot shall abstain from voting (CIVA 2.1.1.4.).
10. The awarding of zero marks is determined by majority, with the Chief Judge having a casting vote (Sporting Code, Section 6, 2.1.16.). It should be noted that when a Judge's vote is over-ruled, upward



correction of a zero must be to the average of the grades given by the scoring judges excluding all zeros. When awarding a zero, judges are not to give a reserve mark. Each judge must correct and sign his/her own score sheet. The Chief Judge shall keep a record of changes made to scoring judges' grades as a result of discussions of matters of fact and use these to modify the statistically calculated JPFs in accordance with Appendix 6.

11. The awarding of penalties or infringements of upper and lower height limitations is decided by majority vote of the judges. In the case the required simple majority could not rise from a vote within the Board of Judges, the Chief Judge shall have the casting vote; a two-thirds majority being required for the penalty of disqualification (CIVA 1.4.4.3., 2.3.2.2.)

12. The Chief Judge shall indicate to the Panel of Judges when they must watch and mark a programme (CIVA 1.4.6.1.), and when they must cease because the contestant has exceeded his time limit (CIVA 2.3.1.1.). He should also note which figures should receive a zero because they have been started behind the Judges (2.1.4.3.).

13. The Chief Judge, assisted by the timekeepers, has the responsibility for the awarding of penalties for improper wing-rocking (CIVA 2.3.1.3.).

14. Judges evaluation by flight programme will be conducted by the International Jury using the software programme approved by CIVA. The Chief Judge will receive a complete analysis of all Judges from the International Jury. Individual Judges will receive only their own evaluation.

The Judges

1. It is required that all Judges use an experienced Judge's Assistant from their own team, together with a writer who may be supplied as a member of the Judge's team or, on request, by the organisers (subject to availability).
2. All Judges should obtain and study copies of all contestants' Free Programmes before flying of the programme is started.
3. A Judge may only reconsider his marks so long as his score sheet is still in his possession. After it is signed and handed in, it comes under the jurisdiction of the International Jury.
4. The preliminary flights by non-competing pilots (CIVA 1.1.8.) will be marked exactly as if they were competitors; bearing in mind that the purpose of these flights is so that the first competing pilot who follows them shall not be penalised by receiving an unduly low 'anchor' mark.
5. It is strongly recommended that the Judges record remarks on the score sheets.
6. Judges shall not keep or make reference to a flight order sheet, whilst on the judging line.



APPENDIX 5 TO CIVA REGULATIONS (PART TWO)

THE AEROBATIC PERFORMANCE ZONE

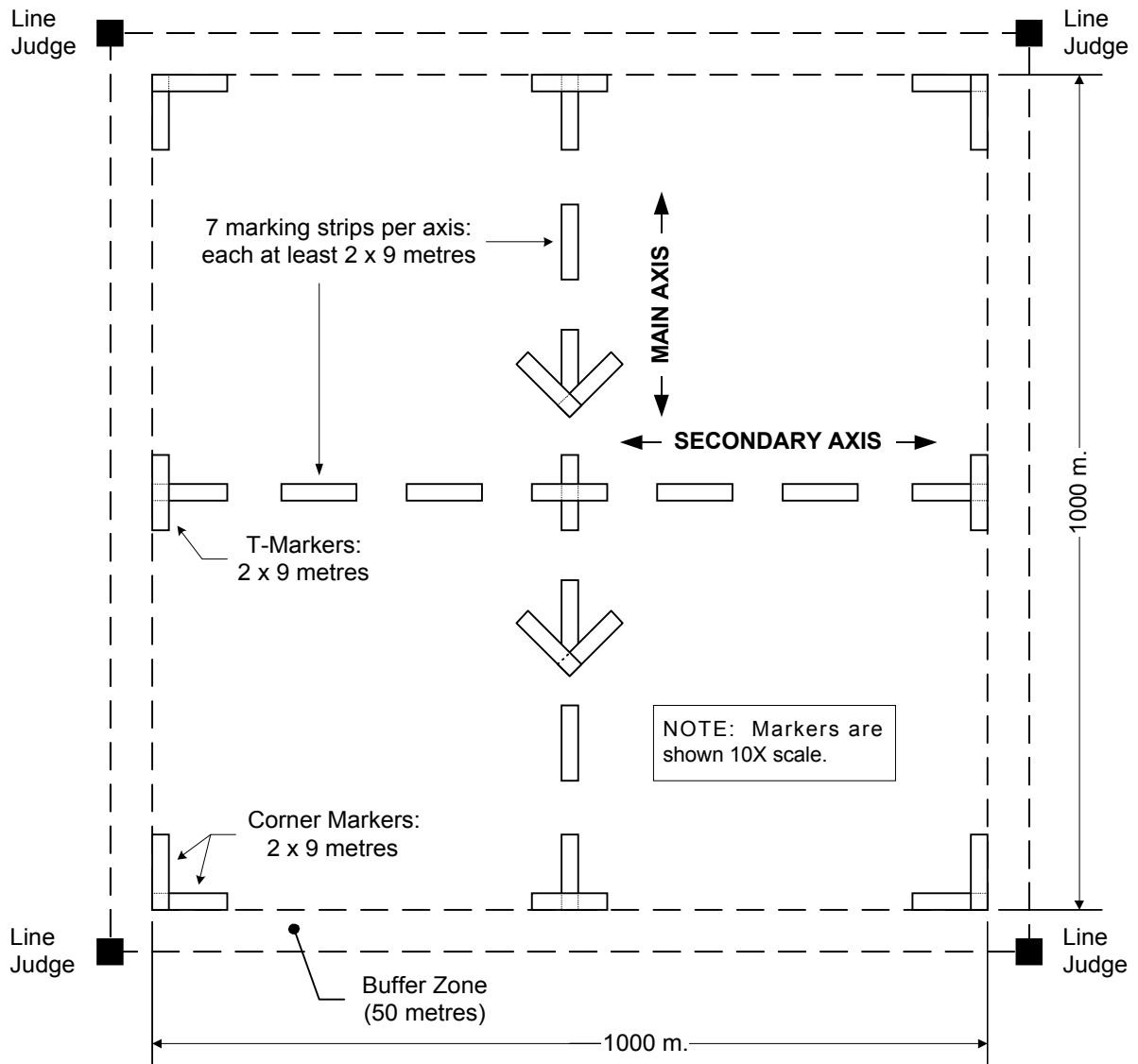



APPENDIX 6 TO CIVA REGULATIONS (PART TWO)

JUDGES PERFORMANCE FACTORS

The JPF system uses the deviation of each judge’s TBLP’ed scores from the mean value of all judges. This is transformed into an easily recognizable Judge Performance Factor. It also incorporates the results of judging-line conferences where minority zeroes or minority non-zero grades have been over-ruled.

Judges give marks from 0 to 10 and this scale is the basis of the measurement of his performance. Therefore, for one Judge Y, all his TBLP scores are recalculated to a mean score. This means for a 500 K sequence (including positioning) a TBLP score of 4,000 points for Pilot A is equivalent to a mean score of 8.0. If the mean value of all Judges on Pilot A is 3,750 points, or a mean score of 7.5, then Judge Y is high by 0.5 on Pilot A.

The deviation of 0.5 is now squared to make large excursions more pronounced. The result would be $0.5 \times 0.5 = 0.25$. This procedure is done for all pilots and all scores from Judge Y. All squared deviations are added up and are divided by the number of pilots to get the mean of the squared deviations.

Example: Judge Y, 500 K sequence = 5,000 points maximum

Pilot	Judge Y Points/Score	Mean All Judges Points/Score	Deviation	Square Deviation
A	4,000 / 8.0	3,750 / 7.5	+0.5	+0.25
B	3,000 / 6.0	3,500 / 7.0	+1.0	+1.00
C	3,500 / 7.0	3,500 / 7.0	0.0	0.00
D	4,250 / 8.5	4,400 / 8.8	-0.3	+0.09
E	2,800 / 5.6	3,000 / 6.0	-0.4	+0.16
F	3,700 / 7.4	3,500 / 7.0	+0.4	+0.16

$$\Sigma 1.66$$

The mean value of the squared deviations = $1.66 \div 6 = 0.277$.

To obtain an easily recognizable number, the value is multiplied by 100. The preliminary JPF in this example is **27.7** ... not a very good judge rating. This procedure is repeated for all judges for this sequence. One mark is then added to this figure for each occasion when a judge has had a zero or non-zero grade changed by majority voting.

When this program was approved, CIVA adopted the following ratings:

JPF	0 to 5	Excellent
JPF	>5 to 10	Good
JPF	>10 to 15	Marginal
JPF	>15	Bad

APPENDIX 7 TO C.I.V.A. REGULATIONS (PART TWO)

WIND LIMITS

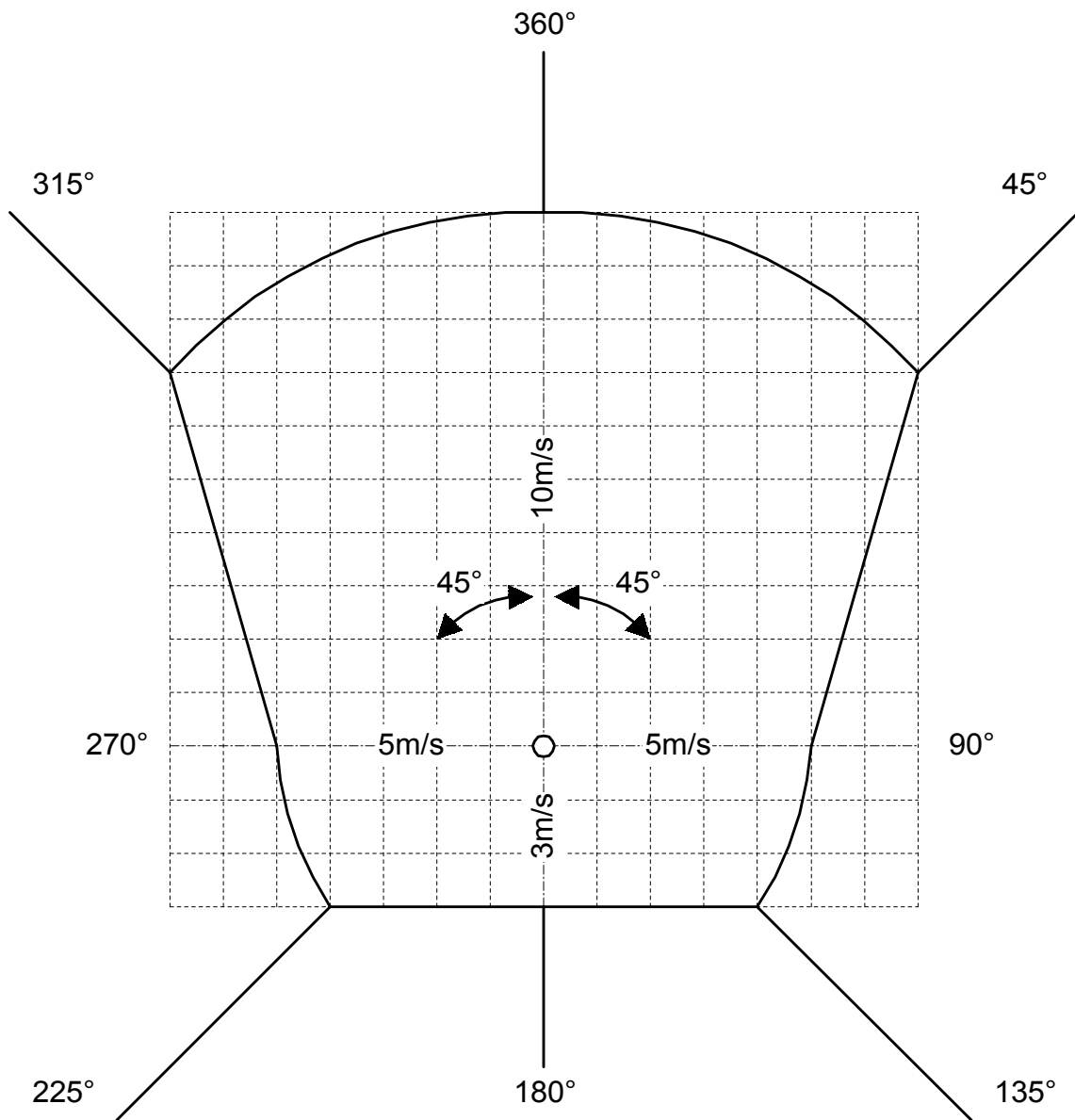



APPENDIX 8 TO C.I.V.A. REGULATIONS (PART TWO)

**RULES FOR THE USE OF THE
HUBER HEIGHT MEASURING DEVICE (HHMD)**

1. Functions of the HHMD

An onboard transmitter sends signals to the ground receiving equipment (at the Chief Judge's position) when the glider descends below the upper or lower height limits or the disqualification height. The ground equipment indicates the height and the identification of the transmitter on an alphanumeric display and emits an audio signal ("beep") whenever signals from one of the onboard transmitters are received.

The HHMD transmitter in the glider cockpit provides the following audio signals to the pilot:

- Functional checks at 100/200 m during tow (one "beep" each);
- Continuous signal ("beep-beep-beep") as long as the glider flies above the upper height limit;

Descent below the upper height limit is indicated by the stop of the continuous signal.

- Descending below 200 m (one "beep");
- Descending below 100 m (one "beep").

If the glider climbs back above the respective height, the signal will be repeated every time it descends below that height again.

2. Characteristics of the HHMD

Taking into account the specified tolerances of the HHMD, the transmitter is set to send the signal for the upper height limit always at a height slightly above the prescribed height. For the lower height limit and the disqualification height, the signal will always be transmitted at a height slightly below 200 m or 100 m respectively.

The guaranteed overall tolerance of the HHMD system is considerably smaller than the tolerances of the conventional altimeters used in gliders. Pilots must further understand that unlike mechanical altimeters, the electronic pressure sensor in the HHMD is not influenced by rate of descent or climb. This means that whilst the mechanical altimeter displays a significant lag during rapid changes of altitude (always indicating low in a climb and high in a descent), the HHMD will transmit its signal instantaneously and exactly at the prescribed height.

3. Operating Procedures for the HHMD

Whenever the HHMD is in use, it will be the primary reference to verify compliance with height limits and for decisions on penalties or disqualifications due to height infringements. HHMD audio signals are recorded together with the video.

A person (Steward) assigned to the Chief Judge will monitor the HHMD ground equipment and log every flight on a specific form, to keep track of proper functioning of the Device and record height infringements.



Installation, setting up, checking, and removal of the HHMD onboard transmitters will be performed by a member of the Technical Commission or a person (Steward) specifically designated for this duty and supervised by the Technical Commission.

All participating gliders must have a mounting bracket for the onboard transmitter as specified in this Appendix.

4. Pilot Procedures for the Use of the HHMD

With the upper height limit at 1200 m (750 m for split programmes), the towing height will be at least 50 m higher, in order to ensure proper functioning of the HHMD.

Competitors may not start their programmes above 1200 m (or 750 m respectively). A penalty of 70 points is given if the first figure is initiated before the 1200 m (or 750 m) signal has been received or if the glider climbs above the upper height limit after starting the first figure. (The wing dip for the start of the programme may come above the upper height limit, as long as the first figure does not start prior to the HHMD signal).

At the lower height limit, a penalty of 70 points is given for every figure flown, before or during which the 200 m signal is received.

If the 100 m signal is received before or during a figure, the competitor will be disqualified.

(Criteria for completion of figures: see CIVA Regulations, Part Two, paragraph 2.4.1.3.)

5. Malfunction or Failure of the HHMD

Whenever a competitor notices or assumes a malfunction of the Device (e.g. the audio signal does not stop below 1200 m), he/she may return for landing without starting the programme. After starting the programme, there is no justification for breaking off due to an assumed malfunction of the HHMD.

As a safeguard against malfunctions of the Device, the judges will continue to record infringements of the lower height limit or the 100 m limit as specified in CIVA Regulations, Part Two, paragraph 1.4.4.4.

A failure of the link between the HHMD and the official video recording equipment has no influence on the validity of the HHMD measurements, as long as the normal functions of the HHMD, as described above, are not degraded.

If the HHMD system becomes unserviceable during the contest, procedures for towing and determining infringements of height limits for subsequent flights will be in accordance with the rules laid down in CIVA Regulations, Part Two.

**HHMD ASSEMBLING UNIT AND INSTRUCTIONS TO PLACE
 THE ALTIMETER ENCODER**

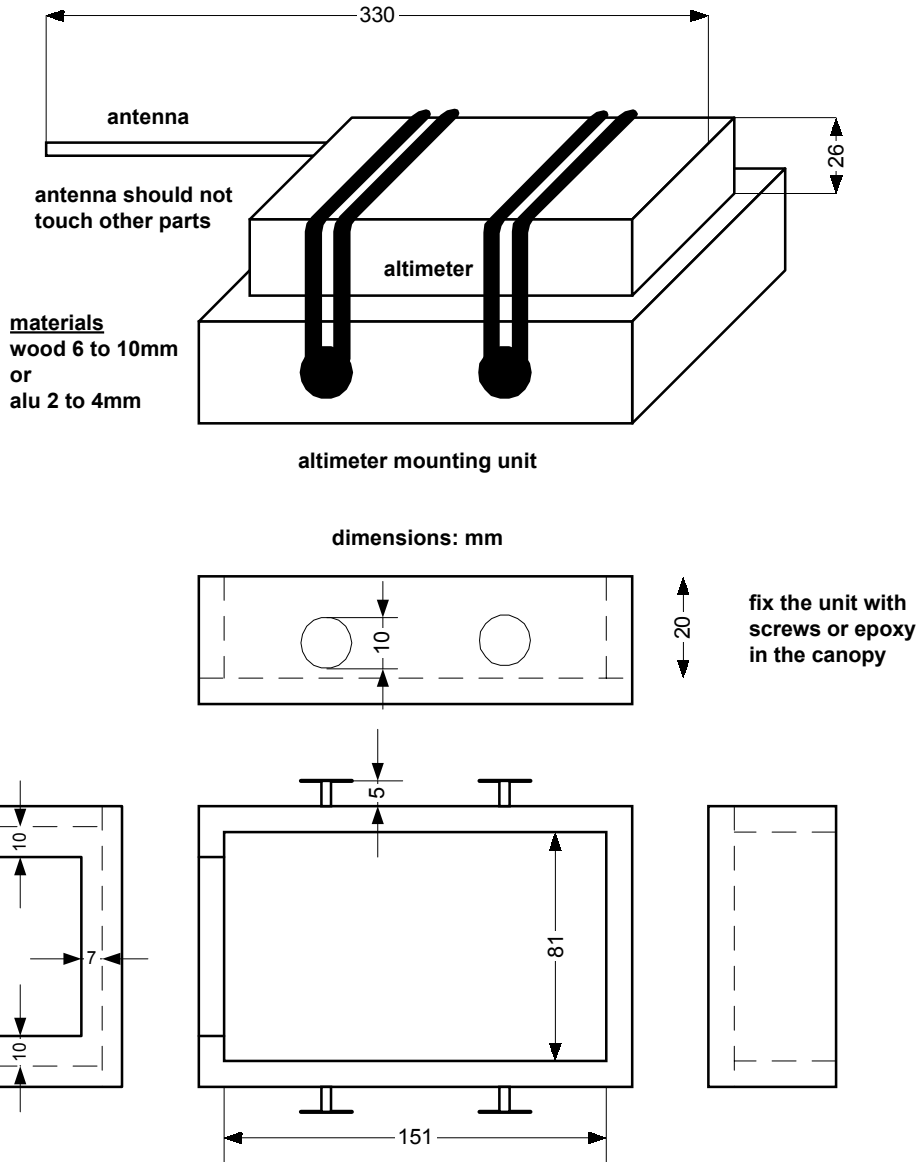

**For any questions:
 call or fax to PETER HUBER**

**e-mail: spc-hupe@eunet.at
 fax: +43-7724-60784**



C.I.V.A. REGULATIONS (PART TWO)
GLIDER AEROBATIC CHAMPIONSHIPS

RECORD OF AMENDMENTS

Amendment Number	Date Inserted
1	1 January 1993
2	1 January 1994
3	1 January 1995
4	1 January 1996
5	1 January 1997
6	1 January 1998
7	1 January 1999
Version 1.01	1 January 2000
Version 2001-1	28 February 2001
Version 2001-2	26 March 2001
Version 2002-1	1 January 2002