

**FÉDÉRATION AÉRONAUTIQUE INTERNATIONALE
AEROBATICS COMMISSION (CIVA)**

**REGULATIONS FOR THE CONDUCT
OF INTERNATIONAL AEROBATIC EVENTS**



**PART ONE
EVENTS FOR POWERED AIRCRAFT
(UNLIMITED CATEGORY)
2000**

**Version 1.01
Amended 11.02.00**

Secretariat of FAI:
Avenue Mon-Repos 24, CH-1005 Lausanne, Switzerland
Tel: +41 21 345 1070 - Fax: +41 21 345 1077 - E-mail: sec@faiorg
Web: www.faiorg



TABLE OF CONTENTS

1.	REGULATIONS FOR THE ORGANISATION OF WORLD AND CONTINENTAL AEROBATIC CHAMPIONSHIPS AND INTERNATIONAL AEROBATIC COMPETITIONS	
1.1.	Administrative Arrangement	3
1.1.1.	Entry Fees	3
1.1.2.	Accommodation, Food, Medical Services	3
1.1.3.	Fuel and oil	3
1.1.4.	Technical Services.....	4
1.1.5.	Interpreters	4
1.1.6.	Briefings	4
1.1.7.	Sequence of Flights (drawing of lots).....	4
1.2.	Programmes of World and Continental Championships	4
1.2.1.	Competition Flights	4
1.2.2.	Programme Q	5
1.2.3.	Programme 1	5
1.2.4.	Programme 2	7
1.2.5.	Programme 3	9
1.2.6.	Programme 4	9
1.3.	International Competitions	9
1.3.1.	Programmes	9
1.3.2.	Winners and Placings	10
1.4.	Operating Regulations	10
1.4.1.	Video/Audio Devices	10
1.4.2.	Meteorological Conditions	11
1.4.3.	Conduct of Competition Flights	12
1.4.4.	Height Limitations.....	13
1.4.5.	Performance Zone	13
1.4.6.	Duration of Flight and Signalling Start and Finish	13
1.4.7.	Measures in Case of Mechanical Defects	14
1.5.	Awards	15
1.5.1.	World Championships	16
1.5.2.	Continental Championships and International Competitions.....	16
1.5.3.	World Air Games	16
2.	REGULATIONS FOR THE EVALUATION OF COMPETITION FLIGHTS IN INTERNATIONAL AEROBATIC EVENTS	17
2.1.	Evaluation of Performance	17
2.1.1.	Judges	17
2.1.2.	Marks for Figures	17
2.1.3.	Calculation of Scores.....	18
2.1.4.	Marking of Positioning	18
2.1.5.	Marking of Programme 4 (Criteria)	18
2.1.6.	Official Video Recording.....	19



2.2	Basis for the Marking of Programmes Q, 1, 2, 3, and 4	19
2.3	Penalty Points Deductible from Total (Averaged) Scores	20
2.3.1.	Time Limits for Programmes	20
2.3.2.	Infringements of Height Limits	20
2.3.3.	Infringements of the Performance Zone	20
2.3.4.	Flight Regulations and Dangerous Flying	20
2.3.5.	Interruption of a Programme	21
2.3.6.	Violation of Safety Manoeuvres	21
2.4	Penalties and Devaluations Applicable to Marks for Figures in Programmes Q, 1, 2, and 3	21

APPENDICES

-1	CRITERIA FOR JUDGING AEROBATIC FIGURES	23
-2	THE TARASOV-BAUER-LONG-PENTEADO (TBLP) METHOD OF CALCULATING SCORES AND RESULTS	43
-3	LIST OF FIGURES FOR PROGRAMMES 2 & 3 (UNKNOWN COMPULSORY)	49
-4	CODE OF PRACTICE FOR THE CHIEF JUDGE AND BOARD OF JUDGES	67
-5	THE AEROBATIC PERFORMANCE ZONE	69
-6	JUDGES PERFORMANCE FACTORS	70
	CHECKLIST OF ANNUAL AMENDMENTS	71



- 1. REGULATIONS FOR THE ORGANISATION OF WORLD AND CONTINENTAL AEROBATIC CHAMPIONSHIPS AND INTERNATIONAL AEROBATIC COMPETITIONS**
- 1.1. ADMINISTRATIVE ARRANGEMENTS**
- 1.1.1. Entry Fees**
- 1.1.1.1. World Championships:
 - a) Every National Aero Club sending a team or solo pilot or officials to World Championships must pay an entry fee for each member of the official team, solo competitors and officials (except judges) to the organising Aero Club.
 - b) Entry fees will be fixed by CIVA on agreement with the organisers.
 - c) The organising Aero Club will notify National Aero Clubs of the date of payment and of the receiving agency.
 - d) Entry fees will be refunded if the World Aerobatic Championships do not take place.
- 1.1.1.2. Continental Championships and International Competitions:
 - a) Every National Aero Club sending participants and officials to the event will pay entry fees to the organizing Aero Club.
 - b) Entry fees will be fixed by CIVA on agreement with the organisers.
 - c) Entry fees will be refunded if the event does not take place.
 - d) The decision on refunding the entry fees for other reasons is left to the organisers.
 - e) No entry fees are required for judges.
- 1.1.2. Accommodation, Food, Medical Services**
- 1.1.2.1. At World Championships, the organisers will provide adequate accommodation and food for the duration of the event to all members of official teams, solo competitors, officials and other assistants for whom entry fees have been paid, on the understanding that no extra charges will be imposed for these services. In addition, airfield charges will be covered for those persons for whom entry fees have been paid. It is recommended a reduced fee be offered by the organisers to entrants who desire to arrange their own accommodation and evening meals.
- 1.1.2.2. The organisers will be responsible for adequate medical services being available to all official participants.
- 1.1.3. Fuel and Oil**
- 1.1.3.1. At World Championships, aircraft fuel and oil will be provided by the organisers for functional test flights and contest flights without imposing extra charge.



1.1.4. Technical Services

1.1.4.1. The organisers will provide technical assistance and hangarage for competing aircraft, if required.

1.1.5. Interpreters

1.1.5.1. Interpreters for English and French, working with the International Jury and the Board of Judges, will be provided by the organisers.

1.1.6. Briefings

1.1.6.1. Prior to the start of a contest there will be a briefing by the organisers for Chief Delegates or Team Managers, members of the International Jury and Judges, on flight conditions, the contest programmes, and any other problems which might arise over the interpretation of the rules.

1.1.6.2. For familiarisation with and a standardised interpretation of the judging rules the Chief Judge will hold seminars with the Judges and Team Managers or other representatives of each team, and carry out at least one judging test for which a non-competing pilot shall be available. Throughout the duration of the contest the Chief Judge will hold routine evaluation meetings with the Judges.

1.1.6.3. Before the beginning of competition flying, on each competition day, a briefing will be held for competitors, officials, judges and the International Jury on organisational matters concerning the competition day, on meteorological conditions, etc. The briefing should last not longer than 30 minutes.

1.1.7. Sequence of Flights (Drawing of Lots)

1.1.7.1. The sequence of flights for Programmes Q and 4 of Championships and International Competitions will be determined by lot to be arranged by the Contest Director or his Assistant, in the presence of a representative of the International Jury. Each competitor will draw his or her own lot. In the event a competitor is not present to draw his or her own lot, a member of that competitor's team may do so.

1.1.7.2. In Programmes 1, 2, and 3, the official combined standings from the previous programme(s) will be used, in reverse order, to determine the order of flight. The results of Programme Q will only be used with respect to Programme 1. The top placing pilot will fly last.

1.1.7.3. The sequence of flights may be altered by the International Jury if special circumstances require.

1.1.7.4. The organisers will ensure that the first two flights of each competition day and each programme will be by non-competing pilots. The Contest Director, with the concurrence of the Chief Judge, may delete the second warm up flight. Team reserve pilots will be utilized, to the extent they are available, by the organisers for this purpose in an equitable way. The intent of this regulation is to permit judges to see a wide variety of aircraft during the warm up flights.

1.2. PROGRAMMES OF WORLD AND CONTINENTAL CHAMPIONSHIPS

1.2.1. Competition Flights

1.2.1.1. Each competitor will make up to four competition flights (Programmes Q, 1, 2 and 3) depending on the cuts made in accordance with 1.2.5.2. Programme 4 will be flown by the highest placed competitors in accordance with the Sporting Code, Section 6, Rule 1.3.1.1.(c).

1.2.1.2. Before the wing-dipping at the start of each competition flight in Programmes 1, 2, 3, and 4 it is recommended that all pilots perform safety manoeuvres as follows. These figures are optional but, if

flown, may only be flown once, in any order, and in the same line without any change in direction of flight of more than 90 degrees. They must be flown inside the performance zone:

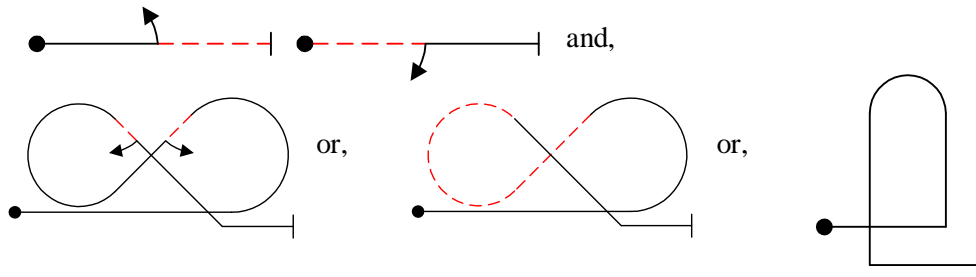

1.2.2. Programme Q - The Known Compulsory Programme

- 1.2.2.1. The Known Compulsory Programme will be composed of figures in normal and inverted flight performed consecutively and continuously, observing the prescribed sequence of the flights.
- 1.2.2.2. The programme must be such as to enable competitors to fly all figures safely in the aircraft available to them, provided that the aircraft meet the requirements of normal technical standards. The figures will be selected from the FAI Aerobatic Catalogue as currently amended by CIVA.
- 1.2.2.3. Programme Q of a World Championship will be selected and made known by CIVA at least six months prior to the beginning of that World Championships.
- 1.2.2.4. Programme Q will have a time limit of 10 minutes maximum from “lift off” to exit from the box (wing dips at completion of flight). During the flight, the pilot will be permitted to fly practice figures prior to and after the actual performance of Programme Q. The end of the 10 minute time limit will be clearly announced by the Chief Judge to the pilot by means of radio. Each Programme Q figure performed after 10 minutes will not be marked by the judges.

1.2.3. Programme 1 - The Free Programme

- 1.2.3.1. The Free Programme may be composed of a maximum of 15 figures or combinations of figures. A combination will be taken as one figure. All figures must be taken from the FAI Aerobatic Catalogue as currently amended by CIVA. The total difficulty coefficient of all figures and combinations of figures shall not exceed 420. No figure may exceed 99 K.
- 1.2.3.2. The start and finish of Programme 1 must be carried out in normal and inverted level flight. Competitors may begin and finish their programme at any height between 100 and 1000 metres above aerodrome level.
- 1.2.3.3. Any figure or combination of figures which is identified in the FAI Aerobatic Catalogue as currently amended by CIVA may be selected to compose the Free Programme
 - a) Any figure or combination of figures which is selected must bear the catalogue reference number(s) and the difficulty coefficient(s) (K) stated in the FAI Aerobatic Catalogue as currently amended by CIVA. The numbers and coefficients in the FAI Aerobatic Catalogue will be taken as definitive.
 - b) A catalogue reference number may be used only once.
- 1.2.3.4. The method of constructing figures and calculating difficulty coefficients is as described in the FAI Aerobatic Catalogue as currently amended by CIVA.



1.2.3.5.

- a) The character and composition of basic figures must not be changed when combining other figures with them.
- b) The direction of rotation of rolls is not prescribed.

However:

- (i) When rolls are in continuous rotation, the tips of the symbols are to be linked by a small line.
 - (ii) In un-linked rolls performed in the same direction, no line links the symbols but the tips must be drawn pointing in the same direction.
 - (iii) In opposite rolls the tips of the symbols must be drawn pointing in opposite directions.
- c) Un-linked rolls in the same direction must be of different types. The two types of rolls are defined as follows:
- (i) Aileron rolls (slow rolls and hesitation rolls).
 - (ii) Flick rolls (positive and negative).

1.2.3.6. Versatility In order to achieve versatility in the design of Programme 1, it is a mandatory requirement that competitors shall include the following:

- A minimum of 1 figure from Family 1
- A minimum of 1 figure from Family 2.5 to 2.15 and 2.17 to 2.20
- A minimum of 1 figure and not more than 3 figures from Family 5
- A minimum of 1 figure from Family 6
- A minimum of 1 figure from Family 7
- A minimum of 1 figure from Family 8
- A maximum of 4 figures from Family 8.1-8.4
- Only 1 figure from Family 9.11 or 9.12

In addition, at least 2 positive (9.9) and 2 negative (9.10) figures must be included. At least one figure must contain opposite rolls.

Programmes not including these figures will not be accepted.

1.2.3.7.

- a) Not later than 48 hours before the start of Programme 1, each competitor must submit three standard CIVA forms for the programme as appropriate to the Contest Director for verification of compliance with the relevant Rules. These forms must be completed legibly in inks which do not compromise subsequent photocopying.
- b) Form 'A' will show all symbols, catalogue reference numbers and coefficients.
- c) Form 'B' will show the continuous sequence of the programme as it would be flown with the wind blowing from right to left.
- d) Form 'C' will show the continuous sequence of the programme as it would be flown with the wind blowing from left to right.
- e) Forms 'B' and 'C' must carry the correct symbol for the wind direction.
- f) The forms will include the conventional symbols, catalogue numbers and coefficients only. No account will be taken of any other writing or notation.



1.2.3.8.

- a) It shall be the duty of the Contest Officials to check the catalogue reference numbers on form 'A' of each competitor with the symbols on forms 'B' and 'C', taking the reference numbers in the FAI Aerobatic Catalogue (as amended by CIVA) as the basic criteria for deciding compliance with the Rules of this section.
- b) The final responsibility for the correctness and compatibility of forms 'A', 'B', and 'C' lies with the competitor. Any inaccuracies in the drawing of symbols or in the quoting of coefficients, or the discovery of any cases of repetition of figures, will be referred to the competitor's Team Manager so that the forms may be corrected and resubmitted.
- c) The Contest Officials referred to in this rule are those of the organiser.
- d) In order to avoid possible alteration and resubmission of forms during the contest, National Aero Clubs may, if they wish, submit the competitor's forms to the organisers for checking not less than one month before the beginning of the contest.

1.2.3.9. Should a competitor disagree with a decision of the Contest Officials concerning his or her Programme 1, a complaint may be put to the International Jury before flying commences in Programme 1. The approved programmes of all competitors will be published before the end of Programme 1, in sufficient time for complaints and protests to be made. Once the flying of Programme 1 has started, no complaints of any kind will be accepted by the International Jury on any aspect of the composition of a competitor's programme.

1.2.3.10. The organisers will be responsible for reproducing a sufficient number of copies of competitors' programmes to meet the requirements of the contest. One set of copies of Programme 1 (Form B only) are to be provided to each Team prior to the start of this programme.

1.2.3.11. The organisers will be responsible for ensuring that the names of the competitors will not appear on Forms A, B, and C.

1.2.3.12. A bonus score will be added to the total score before penalties, for each figure less than 15 which goes to make up a total sequence. Bonus points will be calculated using the percentages in the following table and added to the competitor's final score automatically by the computer scoring program:

# Of Figures	14	13	12	11	10	9	8	7	6
Bonus Pts %	05	5	30	50	75	105	140	180	25

1.2.4. Programme 2 - The First Unknown Compulsory Programme

1.2.4.1. For the Unknown Compulsory Programme, figures will be chosen from Appendix 3. A representative of every National Aero Club which has a pilot (or pilots) competing may submit one figure with a coefficient of no less than 15. A maximum of 10 figures may be submitted. If there are more than 10 Aero Clubs participating, the International Jury will conduct a random drawing to determine which Aero Clubs will submit figures (see 1.2.4.4.). Repetition of any figure with the same catalogue number is not allowed.

1.2.4.2. Sequences for Programme 2 are to be composed using the 10 figures submitted by the Aero Clubs and additional figures from Appendix 3, solely to aid in composition.

- a) In the selection of figures for Programme 2, there will be a limit on the number of figures selected from the following:



Maximum of 2 figures allowed from: Family 6-11, Columns 3 & 4.

Maximum of 2 figures allowed from: Family 8.1-8.4, 8.15-8.18, 8.31-8.34, Columns 3 & 4.

Maximum of 6 flick rolls, only 4 of which can be from the same family (9.9 or 9.10). A minimum of one flick roll must be a vertical climbing manoeuvre (9.9.1., 9.9.6., 9.10.1., or 9.10.6.).

- b) There will not be more than 1 flick roll (Family 9) per figure.
- c) In Family 7 and Family 8, there will be no flick roll (Family 9) after a downward looping segment that finishes in horizontal flight.
- d) Sequences will consist of no more than 14 figures.

1.2.4.3. The contest organiser shall provide copies of the list of figures to all competing National Aero Clubs, and each club may submit a sequence for Programme 2 composed of these figures to the International Jury. Additionally, the contest organiser will determine the deadline for submitting proposed Programme 2 sequences.

- a) The International Jury will select one of the submitted sequences for use as Programme 2 and will insure all figures are as drawn by the National Aero Clubs submitting them, ie entry/exit directions are as drawn.
- b) The International Jury may alter the submitted sequence, if necessary, for safety reasons.

1.2.4.4. If there are pilots competing in Programme 2 from more than 10 National Aero Clubs, 10 of their representatives will be selected to choose figures for the Unknown Compulsory Programme. No team shall have the automatic right to submit a figure. If there are pilots from fewer than 10 National Aero Clubs participating in Programme 2, their representatives will still select only one figure each. The remaining figures will be selected by the International Jury.

1.2.4.5. Figures shall be selected taking into account the performance characteristics of each competing aircraft and the safety of all pilots.

1.2.4.6. The Unknown Compulsory Programme, after being approved by the Chief Delegates or their representatives, will be announced to competitors by the International Jury not less than 24 hours before the time at which the programme is to be flown.

1.2.4.7. Training for the Unknown Compulsory Programme is not permitted. Competitors violating this regulation will be disqualified.

1.2.4.8. The list of figures for Programme 2 (Rule 1.2.4.1.) and Appendix 3 shall be re-approved at each meeting of CIVA which immediately precedes a World Championship. If, within 2 hours of publication, the sequence of figures for Programme 2 chosen by the International Jury (Rule 1.2.4.3.) is shown by a team's representative or solo competitor to be dangerous, then the International Jury shall redesign the sequence without changing the figures selected under Rule 1.2.4.1.

1.2.5. Programme 3 - The Second Unknown Compulsory Programme

1.2.5.1. Programme 3 will be composed and conducted under the same rules as Programme 2 (1.2.4.) A separate drawing of lots of Aero Clubs eligible to submit figures will be held. The International Jury will select a sequence from those submitted as under the provisions of 1.2.4. for Programme 2. The intent of this regulation is that sequences will be different from those submitted for Programme 2, composed with the new figures submitted by Aero Clubs for Programme 3.



- 1.2.5.2. A mandatory cut of 25% of the competitors, without respect to gender, will be introduced on the basis of the final results after Programmes 1 and 2. If there is insufficient time to complete the championships due to weather problems or unforeseen circumstances, the International Jury is authorised to introduce an additional cut of the competitors, without respect to gender, up to a maximum of 50% of the combined standings after Programmes 1 and 2.

1.2.6. Programme 4 - The Final Freestyle Programme

- 1.2.6.1. The selection of figures or figure combinations for this programme need not be made with reference to the FAI Aerobatic Catalogue; there will be no limitation on the number of figures and the total difficulty coefficient.
- 1.2.6.2. For the performance of the programme the time limit will be four minutes.
- 1.2.6.3. The start and finish of Programme 4 may be in normal or inverted flight on a horizontal, ascending or descending path, which must not deviate from the horizontal by more than 45 degrees. Competitors may begin or finish their programme at any height between 100 and 1000 metres above aerodrome level.
- 1.2.6.4. There will be no submission of forms containing the sequence of figures to the Contest Director.
- 1.2.6.5. Smoke may be used at the option of each individual pilot.

1.3. INTERNATIONAL COMPETITIONS

1.3.1. Programmes

- a) Programme Q..... :Known Compulsory Programme

Programme 1:The Free Programme

Programme 2:The First Unknown Compulsory Programme

Programme 3:The Second Unknown Compulsory Programme

Programme 4:The Final Free Programme

Note - it is recommended that the selection of the figures and the composition of Programmes Q, 1, 2, 3 and 4 follow the rules as applied to World Championships.

At least three programmes (ie Known, Free, and Unknown Programme) are required.

- b) The decision on the number of competitors who will have to fly the Final Freestyle Programme will be left to the organisers, but should be handled similarly to the Rules for World Championships.

1.3.2. Winners and Placings

- a) The winners and the second and third placings in the overall Class and Team competitions will be established.
- b) The winners and the second and third placings will be honoured appropriately by the organisers.

1.4. OPERATING REGULATIONS

1.4.1. Video/Audio Devices



- 1.4.1.1. Video cameras may be mounted in/on competition aircraft at the discretion of the pilot.
- 1.4.1.2. The use of technical devices to convey audible information to the pilot is not permitted during World and Continental Championships except for a radio set with a blocked "Safety Frequency". Radio sets are required and must be able to be tuned to the "Safety Frequency". Any other devices, which are not permitted, will either be removed from the competing aircraft or rendered inoperative and sealed by the Technical Commission. Receiving any kind of audible information from a technical device (other than a safety device) will make the competitor liable to disqualification from the contest.
- 1.4.1.3. Failure of a competitor's radio after arrival at the contest site will not be grounds for disqualification. The contest organisers will arrange other means for the safe and orderly dispatch of these pilots.
- 1.4.1.4. Radios, set to the "Safety Frequency", are only for communication from the Chief Judge to the competing pilot for box control purposes and to serve urgent flight safety matters. Use of the Safety Frequency may be discontinued at the discretion of the International Jury if problems occur which compromise its security. In that case, radios will be rendered non-operational by the Technical Commission.
- 1.4.1.5. The "Safety Frequency" will be selected by the organisers and given to the competitor together with the competition papers. The "Safety Frequency" will be monitored during all competition flights, and possibly recorded on tape.
- 1.4.1.6. The organisers (the Technical Commission) will be responsible for technically adequate sealing of radios (without penetrating the interior) assuring that no frequency other than the "Safety Frequency" can be used.

1.4.2. Meteorological Conditions

- 1.4.2.1. Flights will be carried out between the hours of sunrise and sunset at the place of competition. These times may be extended by the International Jury, if required, to a maximum of 30 minutes either side of official sunrise and sunset, i.e. SR minus 30 minutes and SS plus 30 minutes. If the visibility deteriorates within the stated time limits the International Jury will decide upon the start and finish of the competition.
- 1.4.2.2. The minimum height of the cloud base must be 50 metres above the maximum height determined for each competition flight. The minimum prevailing flight visibility, determined with reference to ground features from the midpoint of the contest area at the maximum height for the competition flight, must be 5 kilometres. The maximum permissible average wind speed at the surface is 12 m/sec. At 500 m the maximum permissible average headwind component is 12 m/sec. Maximum crosswind components, in relation to the main axis, are 6 m/sec at the surface and 8 m/sec at 500 m. Maximum tail wind component at the surface and 500 m is 3 m/sec. Competition flight will not take place in precipitation.

In the case of light and variable winds, the decision with regard to the into-wind direction of flight shall take into account the predominant direction of the actual winds. Flight shall commence into the most direct prevailing wind.

- 1.4.2.3. The Contest Director must provide the competitors, the Chief Judge, the Board of Judges and the International Jury with half-hourly information on weather conditions and, at shorter intervals, on wind speed and direction at 500 m height if required due to meteorological developments.

The weather bulletin with information on wind speed and direction will be published on a board at the flight line for competitors upon decision by the Contest Director. The bulletin must include the time of any change in wind speed and direction as well as the time of the bulletin's publication. The Team Managers are responsible for passing these data on to their teams. Under stable weather



conditions adequately meeting the above conditions, half-hourly information is not required. The International Jury will decide upon the necessity of providing this information.

- 1.4.2.4. If the meteorological conditions do not meet the requirements of 4, or if the visibility decreases below 5 km, the Chief Judge after consultation with the International Jury will discontinue competition flights. Such decision may be taken:
- a) if the information in the bulletin from the aerodrome weather service was obtained by balloon ascent.
 - b) if there is information available from competitors who have just finished or discontinued a flight owing to weather conditions which, in the opinion of the pilot, were outside the prescribed limits.
 - c) if the visibility is judged independently by members of the International Jury, the Chief Judge or the competitors to be below the minimum laid down.

In such cases the members of the International Jury should immediately use an aircraft, to be made available for this specific purpose, and arrange for a weather reconnaissance flight in order to observe the horizontal visibility and cloud height

If the cloud is at least 800 m above aerodrome level, and if a majority of Chief Delegates agree, the International Jury may relax the visibility and wind limitations stated above in the interests of completing the first three competition programmes before the end of the contest period

- 1.4.2.5. A competitor may discontinue his or her flight if, in his or her opinion, the weather conditions do not comply with the competition rules, i.e.:
- a) If for the first four programmes the horizontal visibility deteriorates to less than 5 km, or if the cloud height in the performance zone is lower than the prescribed height (1050 m or 800 m), or if precipitation becomes apparent: the competitor may discontinue his or her flight before the beginning of the programme or after no more than 50% of the prescribed figures have been flown. In this case, members of the International Jury should immediately use their test aircraft in order to check the weather conditions in the performance area and to reach a decision on the possible repetition of the competition flight.
 - b) If the wind exceeds the limits specified in 1.4.2.2.: if a competitor during a flight is not able to observe such changes and he or she completes the flight – i.e. if the competitor made his or her flight under conditions which were disadvantageous as compared with other competitors - this competitor is entitled to repeat the flight, except in Programmes 2 and 3.
 - c) The marking for the repetition for a competitor will be continued from that figure which was flown under weather conditions that did not comply with the competition Rules. Such decision will be taken by the Chief Judge on the basis of latest information on the deterioration of the weather conditions.
 - d) If a competitor discontinues his or her flight without sufficient reason, no repetition flight will be allowed.

1.4.2.6.

- a) If during the performance of Programmes Q, 1, 2 or 3 the height of the cloud base is between the height of 1050 m and 800 m above aerodrome level, the International Jury may allow flights to be made in two parts, the competitor being allowed to regain height without penalty to commence the second part.



- b) In the case of Programmes Q, 2 and 3 the International Jury will decide where the break is to occur; in the case of Programme 1, the competitor will indicate on the copies of his or her sequence (see 1.2.3.7.) by means of a red line the point at which the programme will be broken in the event of this being permitted.
- c) If the cloud base subsequently rises to 1050 m pilots may no longer interrupt their flights without penalty; with due warning, i.e. at least 10 minutes in advance, pilots will be advised by the Contest Director (or his staff), following advice to him from the International Jury, when they are to fly without interruption.

Note: even though an interruption may be allowed without penalty by the International Jury, there is no obligation for pilots to interrupt their flight.

1.4.3. Conduct of Competition Flights

- 1.4.3.1. Competition flights at Championships and International Competitions will be made separately in the sequence determined by the drawing of lots or by rank order, as appropriate. No competitor may commence a competition programme before completing the previous one.
- 1.4.3.2. The direction of flight for the start of the Compulsory Programmes shall be determined by the International Jury. The International Jury shall also determine the alignment of the main axis for the Free Programme (Programme 1), but the competitor may choose to start his or her first figure along either axis in either direction, provided he or she shows clearly on the drawings of his or her programme the direction to be chosen.
- 1.4.3.3. There will be, if required, a 30 minute break after every two hours of competition flying for the Board of Judges to have a rest.
- 1.4.3.4. The organiser of World and Continental Championships must establish an efficient radio communication between the contest officials (Contest Director, Chief Judge, Flight Director, Chairman of the Technical Commission, and International Jury) and supervise the running of the contest and the contest rules.

1.4.4. Height Limitations

- 1.4.4.1. The following height limitations have been determined for all contest flights:
 - Upper limit 1000 metres
 - Lower limit 100 metres
- 1.4.4.2. If the organisers do not have any precision height measuring devices available, the upper and lower height limits will not be measured. The organisers will nominate a non-competing pilot who will daily carry out a flight at the heights of 1000, 100 and 50 metres around the performance zone and along the two axes of the performance zone
- 1.4.4.3.
 - a) Disqualification (for the current programme) for infringements of the lower height limit below 50m, by which air safety is endangered, shall be decided by a two-thirds majority vote of the Board of Judges.
 - b) For an infringement of the lower height limit of 100 metres and the upper height limit of 1000 metres by a competitor, observed by a simple majority of the Judges, the competitor will be penalised in accordance with paragraph 2.3.2.1.

1.4.5. Performance Zone



- 1.4.5.1. The programme will be flown with reference to the longitudinal and lateral axes marked on the ground. The performance zone will be a clearly and distinctly marked area of 1000 x 1000 metres whose central point will be the intersection of the axes. The zone must be located adjacent to a suitable emergency landing area.
- 1.4.5.2. The longitudinal (main) and the lateral (secondary) axes shall both be marked by 7 contrasting marking strips. Only one axis system must be visible at a time. The size of these markers must be at least 2 x 9 metres, with the longer side aligned with the direction of the axis. The ends of the axes and the four corners of the box must be clearly marked and also must be at least 2 X 9 metres in size. On the main axis and near the centre point two arrows will be placed, both pointing into the official wind as determined by the International Jury.
- 1.4.5.3. The colour of the marking strips must be in distinct contrast to the ground and other airfield markings, which latter should be removed if possible.
- 1.4.5.4. If the prescribed wind conditions in 1.4.2.2. are not fulfilled, the competition will be discontinued. The International Jury will determine any change of direction of the main axis as may be necessary, and arrange for a rapid shifting of the axes.
- 1.4.5.5. Marking of positioning will be carried out by the Board of Judges. Additionally, the recording of infringements of the performance zone may be carried out either with an electronic positioning instrument or by Line Judges in accordance with the judging rules. If an electronic instrument is in use and becomes inoperable, the International Jury must decide whether Line Judges are to record zone infringements. If Line Judges are to be used at World Championships, the organiser will prepare four corners of the performance zone for the use of four Line Judges to cover this eventuality (see 2.1.4.2. and 2.3.3.1.)



1.4.6. Duration of Flight and Signaling Start and Finish

1.4.6.1.

- a) Programme Q must be completed within 10 minutes from lift-off including any breaks. Programmes 1-3 must be completed within 15 minutes. (Note: "Lift-off" will be defined as the point in time the competitor is visible to the Chief Judge/timers as "off the ground".)
- b) In Programme 4 there is a precise four-minute period to complete the programme after take-off and climb.
- c) The Chief Judge shall indicate by call or signal the time during which the Judges must watch and mark a programme.
- d) If for some reason a general recall is necessary, this will be indicated to competitors and Judges by a red pyrotechnic. A recall is, except in dangerous situations, allowed only up to the beginning of a programme.

1.4.6.2.

- a) A competitor must signal the start and finish of each programme, and any interruption, by distinctly dipping the wing three (3) times immediately one after the other by more than 45 degrees. For timing purposes the programme is deemed to start on the return of the wings to level after the third wing dip; and is deemed to finish on their return to level after the first of the final wing dips.
- b) The aircraft may start and/or finish the wing dips either inside or outside the aerobatic zone. They may be in normal or inverted flight or a horizontal, climbing or descending path. If the first figure in a programme begins in inverted flight, all wing dips must be performed in inverted flight. The competitor may change his flight attitude from normal to inverted only by a half roll prior to the first wing dip. The return of wings to 'level' therefore does not necessarily refer to the aircraft being 'in level flight'.
- c) A horizontal flightpath is required at the start of the first figure. This horizontal may be started inside the aerobatic zone or, provided that it is clearly seen to continue inside, it may be started outside the zone.

1.4.6.3. For exceeding the time allowance on either side of the four minute period for Programme 4, paragraph 2.3.1.2. applies.

1.4.7. Measures in Case of Mechanical Defects

1.4.7.1.

- a) In the event of a competing aircraft becoming unserviceable before the start of a flight, the International Jury may, on the recommendation of the Technical Commission, permit the competitor to use another aircraft or the same aircraft following the removal of the defect.
- b) In the event that a test flight is required and the competitor does not allow a non-competing pilot to fly his aircraft for test purposes, a special authorization will be given to the competitor to fly this test flight under the following conditions:
 - (i) that the flight will consist of a maximum of three aerobatic figures;
 - (ii) that these figures will be recommended by the Technical Commission and approved by the International Jury;



(iii) if the competitor violates these conditions he will be disqualified

1.4.7.2.

- a) When a competitor has a mechanical defect in flight and decides to land, he/she will be required to taxi (if able) to a designated secure area that is protected from spectators and other team members. This area will be off limits to everyone except the competitor, the Technical Commission and the International Jury. An engineer from the competitor's team will be permitted to enter the area with the concurrence of the Jury. The competitor will be required to remain in his aircraft until the arrival of a member of the International Jury who will release him and subsequently permit the aircraft to be worked on and inspected.
- b) In the event of a competitor breaking off his or her competition flight in case of technical damage which is beyond the pilot's control after take-off, he or she may be allowed to repeat the flight provided that evidence of the damage can be furnished to the Technical Commission within two hours after landing. For finding the damage only, the following persons will be permitted to work on the aircraft: the competitor and the mechanic named by the competitor, plus members of the Technical Commission (except the one belonging to the pilot's Aero Club) and the International Jury. When the cause of the damage has been found, the damage will be repaired by the mechanic of the aircraft and other experts, as recommended by the Technical Commission.

1.4.7.3. Any damage will be counted as such provided it is a break or deformation found on the aircraft or engine or their component parts without use of any special device except a magnifying glass.

1.4.7.4. The following defects will not be counted:

- a) incorrect adjustment;
- b) technical trouble caused by dirt if attributed to negligence of the competitor or his/her team. Note: if it can be ascertained by the Technical Commission that contaminated fuel or oil was supplied by the organisers, the penalizing rule does not apply;
- c) insufficient or missing safety devices causing a change of settings during the flight.

In cases (a) or (c) (with the exception of the Note in (b)), the competitor will not be permitted to repeat his or her flight.

1.4.7.5. The International Jury must, not later than five hours from the landing of the competitor concerned, decide whether or not a repetition flight will be approved. In case of doubt on the basis of the statement by the Technical Commission, the International Jury shall decide in favour of the competitor.

1.4.7.6. In order to avoid any delay in the progress of the contest, the flight will be repeated at the end of the current programme, even if this is prior to the decision of the International Jury.

1.4.7.7. The sequence of repetition flights is determined by the sequence of interruptions of competition flights.

1.4.7.8. A competitor making a repetition flight must re-fly the entire programme. Judging and scoring will be continued from the figure during which the technical problem occurred in the interrupted programme.

1.5. AWARDS

1.5.1. World Championships



- 1.5.1.1. The Overall Men's and Women's World Champions respectively will be awarded the Gold Medal and Diploma of the FAI. The second and third placings will be awarded an FAI Silver and Bronze Medal respectively and Diplomas of the FAI.
- 1.5.1.2. The Overall World Champion of the men or women will be awarded the Jose L. Aresti Cup.
- 1.5.1.3. The Overall Women's World Champion will be awarded the Royal Aero Club Trophy donated by the United Kingdom.
- 1.5.1.4. The World Champions, second, and third placings in the various programmes will be awarded Medals by the organisers and Diplomas by the FAI. Medals will be presented for each Unknown programme.
- 1.5.1.5. The World Champion in the Unknown Programme (combined results from Programmes 2 and 3) will be awarded the Eric Müller Trophy donated by Switzerland.
- 1.5.1.6. The World Champion in the Four Minute Freestyle Programme will be awarded the Manfred Strössenreuther Trophy donated by the Federal Republic of Germany.
- 1.5.1.7. The Men's and Women's World Team Champions will each be awarded the Gold Medal and Diploma of the FAI. The second and third placings will be awarded FAI Silver and Bronze medals respectively and Diplomas of the FAI.
- 1.5.1.8. The Men's World Team Champions will be awarded the Petr N. Nesterov Cup donated by the USSR.
- 1.5.1.9. The Women's World Team Champions will be awarded the FAI Challenge Cup donated by the USSR.
- 1.5.1.10. The top placing Team (Men's or Women's) from the southern hemisphere will be awarded the Southern Cross Trophy donated by South Africa.
- 1.5.1.11. The organisers are recommended to give awards at World and Continental Championships to the Chief Judge, the Panel of Judges, the Chief of the Scoring Office and all the specialists in the computing room.

1.5.2. Continental Championships and International Competitions

- 1.5.2.1. The Overall Men's and Women's Continental Champions, respectively, will be awarded the Gold Medal and Diploma of the FAI. The second and third placings will be awarded an FAI Silver and Bronze Medal, respectively, and Diplomas of FAI.
- 1.5.2.2. The Continental Champions, second, and third placings in the various programmes will be awarded Medals by the organisers and Diplomas by the FAI.
- 1.5.2.3. The Men's and Women's Continental Team Champions will each be awarded the Gold Medal and Diploma of the FAI. The second and third placings will be awarded FAI Silver and Bronze medals respectively and Diplomas of the FAI.
- 1.5.2.4. The Overall European Champion will be awarded the Manfred Strössenreuther Trophy donated by the Federal Republic of Germany.
- 1.5.2.5. The European Team Champions will be awarded the Igor Egorov Trophy donated by the USSR.

1.5.3. World Air Games



Medals and Diplomas awarded at the World Air Games will be identical to World Championships (see 1.5.1.)

2. REGULATIONS FOR THE EVALUATION OF COMPETITION FLIGHTS IN INTERNATIONAL AEROBATIC EVENTS

2.1. EVALUATION OF THE PERFORMANCE

2.1.1. Judges

2.1.1.1. Each programme of World and Continental Championships, i.e. Known Compulsory, Unknown Compulsories, and Free Programmes, will be marked by the Judges using a standardised system: see Appendix 1 to CIVA Regulations and also 2.3 and 2.4 below. The same rules should apply to International Competitions.

2.1.1.2. The marks given by a Judge to a pilot of his/her own country shall be included.

2.1.1.3. Where the majority decision of the Panel of Judges is required, in a case of disagreement about the penalization of the flight of a competitor, the Judge of the same country as the competitor shall abstain from voting. In case the required simple majority could not rise from a vote within the Board of Judges, the Chief Judge shall have a casting vote.

2.1.2. Marks for Figures

2.1.2.1. The Judges will independently assess the quality of each figure and its components as performed in the sequences for Programmes 1, 2 and 3, marking with numbers from 0 to 10 accurate to 0.5; for Programme 4 the assessment will be in accordance with 2.1.5. and the accuracy will be to 0.1. The highest possible mark is 10. These marks at the same time reflect the percentage quality of the competitor's performance (0 - 10 = 0% - 100%).

2.1.2.2. The scores will be calculated by multiplying the coefficient (K) for each figure by the mark given to each.

2.1.2.3. When marking the quality of the performance of individual figures, and when using marks 0 to 10, the Judges have to consider the following general principles:

- a) the geometry of the figures (including shape, radii, angles, plane of flight, direction of flight), which must be in compliance with the prescribed characteristics;
- b) the precision of the performance, for which there are Marking Criteria set out in Appendix 1;
- c) the smoothness of the performance;
- d) the distinctly recognizable start and finish of each figure with a horizontal line;
- e) For Programmes Q, 1, 2 and 3 note also that the figure flown must be in accordance with the pre-stated figure in the original sequence;
- f) that in judging a figure which comprises a combination of manoeuvres, the marking criteria of its various components continue to apply, but the combined manoeuvres are to be taken as a unit;
- g) that the length of lines and the size of radii caused by the flying characteristics of an aircraft are not to be taken into account in the marking;
- h) that inverted performances of figures are judged by the same criteria as upright figures.



2.1.2.4. Once horizontal flightpath is established at the end of a figure in a sequence, the beginning of the next figure is considered to have occurred. This rule is not to be interpreted to mean that a competitor will incur penalty points for performance zone infringements (see 33) if the next figure is actually performed inside the 50 m boundary of the performance zone.

2.1.3. Calculation of Scores

The calculation of scores for a competitor's programme will be as follows:

- 2.1.3.1. The marks given by a Judge are processed according to CIVA Regulations, Appendix 2, with the final scores being determined for a programme as a whole. The CIVA-approved software programme must be used and obtained from the President of CIVA.
- 2.1.3.2. It shall be a duty of the organiser to arrange for the publication of the competition results in accordance with Rule 2.1.3.1. The marking sheets must be made available to the competitors, Chief Delegates, Team Managers, and Contest Officials for information and/or checking before the start of the subsequent programme.
- 2.1.3.3. A copy of the files generated by the CIVA-approved Computer Scoring System must be available to any official or Team Manager upon request. The media used for that copy will be supplied by the requester and has to be compatible with the computer being used by the contest organisers. This could include serial or parallel data transfer techniques if diskettes are not available. A fee of \$25.00 will be charged for the copy of all data, except for the data supplied to the International Jury. A complete copy of all the files must be sent to the President of CIVA after the contest is finished and the media used shall be supplied by the contest organiser. No fees will apply in that case.

2.1.4. Marking of Positioning

- 2.1.4.1. If an electronic, radar or radio-controlled tracking instrument is operated, the observance of the performance zone and of the positions of the individual figures are recorded.
- 2.1.4.2. For conventional marking of positioning, the positioning mark will be given by the Board of Judges. At the discretion of the organiser, infringements of the performance zone may be recorded by Line Judges.
- 2.1.4.3. A mark of "0" will be given for any figure started behind the Judges.
- 2.1.4.4. The competitors should try to perform their programmes within the available airspace in axial symmetry. The highest marks will be given if the central point of a competition flight is above the y axis and at the optimum distance from the Judges.

The K factor accorded to positioning marks will depend on whether infringements of the performance zone are being recorded and, if so, whether by Line Judges or an electronic instrument

Flight Programme	No Infringements Recorded	Infringements Recorded	
		Electronic Instrument	Line Judges
Programme Q	K = 60	K = 20	K = 10
Programme 1	K = 60	K = 30	K = 20
Programmes 2 & 3	K = 60	K = 20	K = 10

2.1.5. Marking of Programme 4 (Criteria)

Programme 4 (Final Freestyle Programme) will be marked under four headings:



Criteria	K-factor
Originality	60
Versatility	60
Harmony & Rhythm	60
Execution	60
Total	240

2.1.6. Official Video Recording

- 2.1.6.1. An official video recording from the Judges' position must be made of every individual competition flight in a World or Continental Aerobatic Championship. The official recording must be available to the International Jury to assist their decision on any protests regarding the evaluation of a competition flight. The recording shall not be available to competitors or Team Officials at a World or Continental Aerobatic Championship, except in conjunction with the International Jury's decisions on protests and with their agreement. After the completion of the championships, the recording may be released by the organisers for use in training.
- 2.1.6.2. The official recording shall also be available to the Chief Judge and the Board of Judges to assist their decision on request.
- 2.1.6.3. Organisers must provide quality equipment with qualified operators to insure useful information is provided to the judges and International Jury for their decisions.

2.2. BASIS FOR THE MARKING OF PROGRAMMES Q,1, 2, 3,AND 4

	Q	1	2 & 3	4
Precision of individual figures, or Execution	---	Max 420K	---	60K
Positioning	See 44			---
Versatility	---	---	---	60K
Harmony & Rhythm	---	---	---	60K
Originality	---	---	---	60K



2.3. PENALTY POINTS DEDUCTIBLE FROM TOTAL (AVERAGED) SCORES

2.3.1. Time Limits for the Programmes

- 2.3.1.1. Figures of Programmes Q, 1, 2, and 3 finished beyond the prescribed time for climbing and flying the programme (ie after 10 minutes for Programmes Q and 15 minutes for 1, 2, and 3) will not be marked by the Judges. The end of the time allowed will be signaled by the Chief Judge.
- 2.3.1.2. Any deviation by more than 10 seconds from the 4-minute time allowed for Programme 4 either side of this time limit will incur 10 penalty points for each further second or each further fractional part of a second.
- 2.3.1.3. Failure of a competitor to observe precisely Rule 46 in Programme 4 (signalling start and finish) will result in a penalty of 150 points. To check and decide on this is the responsibility of the Chief Judge assisted by the timekeepers.

2.3.2. Infringement of Height Limits

- 2.3.2.1. For every obvious and visually recognised infringement of the lower height limit during the performance of Programmes Q, 1, 2, 3 and 4, the competitor will be given 250 penalty points; an additional 250 penalty points will be given for each figure flown completely below the lower height limit; for an infringement of the upper height limit 50 penalty points are given. A competitor flying lower than 50 metres will be disqualified (from the current programme) for causing a dangerous situation.
- 2.3.2.2. Infringements of the lower and upper height limits will be estimated by the Judges and will be penalised only if a simple majority has recognised the violation and duly recorded this on their marking sheets. In case the required simple majority could not rise from a vote within the Board of Judges, the Chief Judge shall have a casting vote. An infringement of the lower 50 m level must be agreed by at least a two-thirds majority of the Judges.

2.3.3. Infringements of the Performance Zone

- 2.3.3.1. The performance zone for all programmes will be 1000 metres each for the main (x) and the cross-wind (y) axes. For Programmes Q, 1, 2 and 3, infringements may be recorded by a technical device or by four Line Judges. Contest organisers may decide to dispense with the recording of performance zone infringements, in which case the highest K factors will be used for positioning marks (see 2.1.4.4.). The decision to adopt this option will be published not later than the second contest bulletin.
- 2.3.3.2. For each infringement of the performance zone in Programmes Q, 1, 2 and 3 by more than 50 metres in the direction of the x-axis and/or the y-axis a pilot will be given 30 penalty points; this applies to the operation of either the conventional or the technical method (i.e. either visual observation or tracking).
- 2.3.3.3. If the conventional method is used, each infringement beyond 50 metres outside the performance zone will be penalised by 30 penalty points; and thereafter, for every figure started beyond 50 metres outside the performance zone, 30 penalty points will be given.

An infringement is considered to have occurred if the fuselage of the aircraft is seen by the Line Judges to have crossed the line being observed, even if this occurs more than once in a single figure.



2.3.4. Flight Regulations and Dangerous Flying

Competitors found guilty of violating flight regulations and/or causing a dangerous situation will, on the recommendation of the International Jury, be disqualified by the Contest Director. The Chief Judge may, with the agreement of two-thirds of the Board of Judges, exclude a pilot who is not flying safely or could cause an unsafe situation. This would apply from takeoff to touchdown (see Section 6, 74)

2.3.5. Interruption of a Programme

2.3.5.1. A competitor will be given 150 penalty points if he or she interrupts his or her programme:

- a) in order to make a change of direction between two figures (more than 90°);
- b) in order to regain height, in the case of height difficulties;
- c) the addition of a figure to a sequence will result in 150 penalty points but all subsequent figures correctly flown will be marked. For example, if the additional figure flown is a repeat of the previous figure, the score for the original figure must be retained, even if zero. Under no circumstances should a competitor be allowed to gain an advantage due to this additional figure.
- d) When an interruption occurs along the y axis, the competitor must resume his or her flight in the same direction of flight.

2.3.6. Violations of Safety Manoeuvres

A penalty of 30 points will be given for each and every figure flown outside the box and other than the prescribed manoeuvres set out in Rule 1.2.1. (b).

2.4. PENALTIES AND DEVALUATIONS APPLICABLE TO MARKS FOR FIGURES IN PROGRAMMES Q, 1, 2, AND 3

It is assumed by a Judge that a contestant is going to fly a perfect figure, therefore he/she starts with the grade of 10 and proceeds to downgrade this mark (a) by fixed values as prescribed herein, and (b) by further values in conformity with the Judging Criteria in Appendix 1.

- 2.4.1. The absence of a distinct horizontal start or finish to a figure will reduce the mark by 1 point in each case for each figure affected.
- 2.4.2. At the completion of a figure, each deviation from the correct direction of flightpath will attract a reduction of 0.5 points per 5° of deviation, 1 point per 5° of deviation.
- 2.4.3. The competitor should, prior to beginning the next figure, correct any errors in direction, etc. Failure to do so will result in a repetition, for each subsequent figure containing the error, of 0.5 points per 5° of deviation, 1 point per 5° of deviation.
- 2.4.4.
 - a) All deviations from the correct geometry (plane of flight, direction of flight, angle of bank), and for deviations from the proper flight path or the proper attitude (as appropriate), the mark will be reduced by 1 point per 5° deviation.
 - b) Over-rotating a roll and rolling the wings back again must be penalised by 1 point per 5° of over-rotation, even if the correct geometry is resumed afterwards, and no matter how quickly the correction is made. The same provisions apply when, at the end of a loop or part-loop, the aircraft's nose is pitched beyond the desired line and then brought back again.



c) If within a figure two or more lines have to be of the same length, an observed variation must be penalised by reducing the marks in the following way:

- a visible variation - with 1 point;
- if the length vary by 1:2 - with 2 points;
- and so forth - up to 3 points.

The basis for judging is the first line flown.

d) The absence of one of these lines before OR after a roll has to be penalised by 1 additional point. If there are no lines before AND after the roll the total penalty is 2 points only.

2.4.5. Slow rolls flown in combination with a turn (family 3 - 15) or loop (family 7) must be smoothly continuous: ie there must not be any change in the rate of roll from beginning to end. If the competitor stops the roll, there will be a reduction of the mark by 2 for each stoppage. If there is any recognisable variation of the angular velocity about the longitudinal axis, there will be a reduction of the mark by 1.

2.4.6. Marking criteria for combinations of rolls with turns and loops will include the even integration of the rolls within the figure. If the total pre-stated number of rolls is completed before the appropriate point in the figure, the mark will be reduced by 1 point for every 5° of the remaining segment of the turn or loop.

2.4.7. A mark of "0" will be given to a figure if, by majority decision of the Judges,

- a) the remaining segment of the turn or loop (Rule 2.4.6.) exceeds 45° of the whole figure;
- b) any deviation from the prescribed direction (Rules 2.4.2. and 2.4.3.) exceeds 45°;
- c) any other deviation in geometry/flightpath/attitude (Rule 2.4.4.) exceeds 45°;
- d) the pre-stated figure or any part of it is omitted;
- e) any figure is flown which deviates from the drawing held by the judges for marking purposes (Form 'B' or 'C'). Note - when a figure is added to a sequence Rule 2.3.5. (c) applies.
- f) any part of the figure was not visible as it was flown in or behind cloud.

However, if figures subsequent to the zero mark are correct and are flown in the correct direction, they shall be marked in the normal way.

2.4.8. When difficulties occur in interpreting the correct application of the "0" mark, the Chief Judge must call for a discussion on the spot by the International Judges.

Such discussions shall not interfere with the subsequent flights. Form A shall be retained until the final decision is made at the next possible break. This includes the possible use of the video recording.

APPENDIX 1 TO CIVA REGULATIONS (PART ONE)

CRITERIA FOR JUDGING AEROBATIC FIGURES

A. PREFACE

The following is an expansion and clarification of the general principles for grading aerobatic figures stated in CIVA Regulation 2.1.2. The final grade awarded to a figure has many facets, but the first and most important component in any grade is the geometry of the figure as compared to the true horizon and Aerobatic Box axes. Geometry is derived from two distinctly different entities: flight path and attitude.

B. DEFINITIONS

There are some words and phrases which are used consistently throughout the text in a very precise sense, and it is as well to define at the start the sense in which each is used:

Angle of attack The angle at which the wings of an aeroplane meet the relative airflow.

Angle of incidence The angle at which the wing is attached to the aeroplane.

Figure Each individual component of a sequence, which may comprise one or more manoeuvres in combination; it starts and ends with a horizontal line.

Manoeuvre Any one of the basic aerobatic movements, which may be combined to make a figure (e.g. an avalanche is one figure consisting of two manoeuvres -- loop and flick roll).

Score/Mark/Point **Marks** are assigned (from 0 to 10) by judges, and may be devalued by various **point** values. The **score** is calculated by multiplying the judges' marks by the coefficients (K factors) and adding the products.

C. FLIGHT PATH AND ATTITUDE

Flight Path

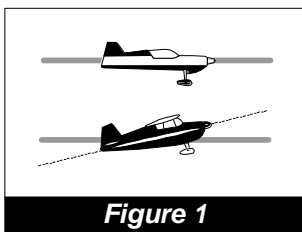

Think of the airplane condensed into a single dot and watch the path this dot takes through the sky. This is the flight path, or track, of the aircraft's center of gravity. Judging the flight path consists of comparing the observed path with fixed references such as the horizon or the X and Y axes of the Aerobatic Box. (Figure 1)

Vertical Attitude

Judging vertical lines is based on the attitude of the aircraft and not its flight path. When an aircraft's flight path, in a zero wind condition, is exactly 90 degrees to the horizon, the wings are being held at the correct angle to produce no lift. The aircraft's attitude while in this condition (zero lift) defines the proper judging criterion for vertical attitude. This is called the zero-lift axis.

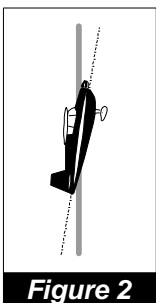

- (a) When this zero-lift axis is vertical, the longitudinal axis of some aircraft may not appear to be vertical. (Figure 2) The Judge must determine the proper vertical attitude for each aircraft type according to its zero-lift axis. The best opportunity to make this determination is to observe practice flights and note the different aircrafts' vertical attitudes, both up and down.
- (b) An aid for judging the perfect vertical (zero-lift) attitude is to observe vertical rolls. During a truly vertical roll, the aircraft's wings will constantly be parallel to the horizon, something which is especially noticeable after 90 degrees of roll.
- (c) Be aware that aircraft types whose zero-lift axis does not pass through the tail will make a spiral with the tail during a perfect vertical roll. From the Judges' perspective, this spiral will look as if the tail is shifting off-axis from the zero-lift axis flight path.

When there is a wind of any kind, the observed flight path will be offset from perpendicular to the horizon by some degree. This wind effect must be completely ignored by the Judge, who must only evaluate the accuracy of the vertical attitude. (Figure 3)

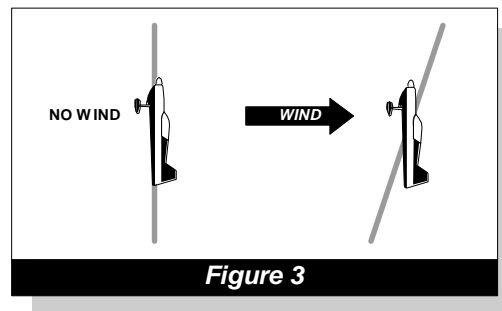

The 45 Degree Attitude

This is the vertical attitude plus or minus 45 degrees. In view of the difficulty in judging 45 degree lines accurately, scoring deductions should be applied with care. When flown into the wind, a perfect 45 degree line will appear to be steep while the opposite is true when flown downwind. (Fig 8.1.4) As with the vertical attitude, this wind effect must be completely ignored by the Judge who must only evaluate the accuracy of the 45 degree attitude. The prescribed deduction is one (1) point per five (5) degrees of deviation from the correct geometry (0.5 points per 2.5 degrees).

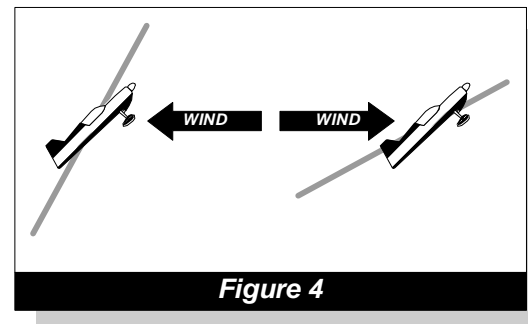

D. GRADING

All transitions from one plane of flight to another should have a reasonable and constant radius. The size of that radius is not a grading criteria and higher grades are not to be given to "square, high-G" corners.

It should be assumed that a competitor is going to fly a perfect figure, so a Judge starts with a grade of 10. As the figure is performed, the Judge then begins to find faults (if any) with what he or she sees, and starts downgrading as the figure progresses. This system of grading is required by the rules as opposed to waiting until the figure is finished and assigning a grade based on overall impression. The latter causes the judging to be erratic and inconsistent.

Summary

Remember, it is the Judge's job to find fault: be a nit-picker. On the other hand, give a grade of 10 if you see a perfect figure - but if you are really being critical you won't see too many. Don't get in a rut. Guard against

confining your grades in too narrow a range. If you watch carefully and grade consistently, you will find yourself giving an occasional 2, 3, or 4 on some sloppy figures that are not quite bad enough for a zero. You will also be giving an occasional 9 or 10 for the superlative figure with which you can find little or no fault. Take care not to grade on an overall impression of a flight. Be ready to award a low grade for a poor figure even if you have been grading other figures flown by that competitor with 8's and 9's.

On the other hand, when you see a competitor barely getting through the figures and you have been giving 4's and 5's, don't be afraid to award a 9 for the almost perfect 90 degree turn that you just saw.

Finally, and most importantly, only grade what you see. If you can't see anything wrong with a figure, don't deduct any points, even if you think there must be something wrong. Always give the competitor the benefit of the doubt.

E. WIND CORRECTION

There are two kinds of wind correction: correction for figure geometry (shape) and correction for Aerobic Box positioning.

The competitor is required to make the shape of all loops and part-loops within a figure perfectly round as seen by the judge on the ground. Wind correction is required for loops and part-loops within figures so that the aircraft's flight path describes a constant radius circle or part circle. Remember, the Judge grades for the roundness of the flight path. Any deviation from perfect roundness must result in a reduction of the score for that figure.

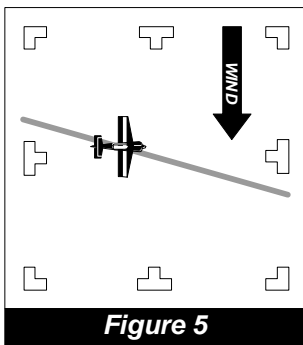

Figure 5

The competitor is also required to keep the aircraft within the Aerobic Box. This becomes more of a problem when a wind is blowing at an angle to the X axis. (Figure 5) The primary method of dealing with cross-box drift is to include a "wind corrector" figure in the sequence. A wind corrector is a figure which places the aircraft onto the Y axis. Because the Y axis is non-directional, the competitor can turn onto the Y axis in the direction which will allow an upwind position change before flying a subsequent figure which returns the aircraft to the X axis.

A well designed Free Program will always include at least one, and preferably more, wind corrector figures. Not every Known Compulsory or Unknown Program contains sufficient (or any) wind corrector figures, however, in this case, it is up to the competitor to keep the aircraft within the Aerobic Box without benefit of a specific Y axis figure to accomplish it.

A common approach is to crab into the wind as done in navigational flight. (see Figure 6) Crabbing means that the aircraft's heading is at an angle to the competition axis (X or Y). The downside to this approach is that if this heading angle can be detected by the Judge, a deduction of one (1) point per five (5) degrees will be given.

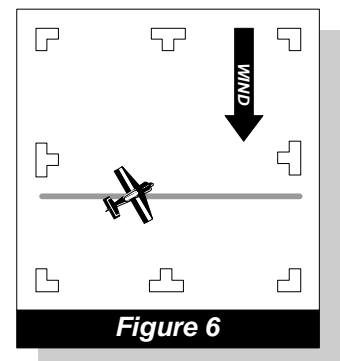

Figure 6

It is possible for the competitor to correct for wind in such a manner that the attitude remains absolutely true to the correct geometry of the figure but the flight path has a sideways component. It goes beyond the scope of this document to provide a tutorial on how this may be accomplished, but what is clear is that if any yaw (heading) deviation or bank angle is visible to the Judge, the score must be reduced at the rate of one (1) point for every five (5) degrees of deviation detected.

Please note, however: even if it is plainly evident that the aircraft has moved laterally within the Aerobatic Box, if the method of that movement cannot be detected by the Judge, no deduction for such correction must be made.

F. THE TWO BASIC COMPONENTS OF AEROBATIC CONSTRUCTION: LINES AND LOOPS

Lines

All lines are judged in relation to the true horizon and the Aerobatic Box's axes. Horizontal lines are judged on flight path, not attitude. Different aircraft at different airspeeds will employ different attitudes to maintain a horizontal flight path. (Fig 8.1.1) While maintaining a horizontal flight path, the aircraft's heading must remain parallel to the X or Y axis. The deduction for deviation in either axis is one (1) point per five (5) degrees from the correct geometry.

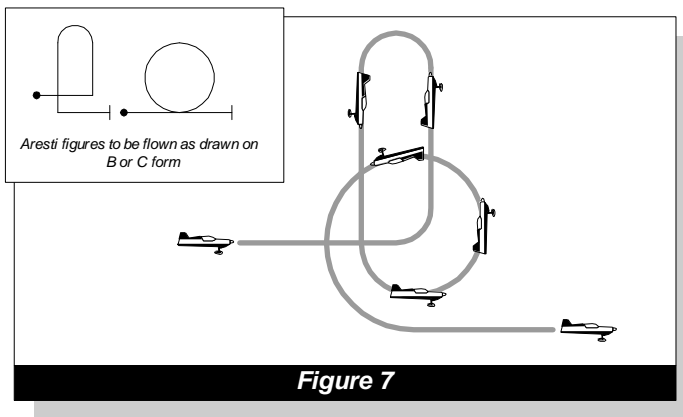

(a) All figures begin and end on definite horizontal lines, and both must be present in order to earn a good grade. A competitor who rushes from one figure to another without showing this horizontal and well-recognizable line will be downgraded by one (1) point for each missing line in each figure affected. Therefore, leaving out the line between two figures will downgrade the preceding figure by one (1) point and the following figure by one (1) point. (Figure 7)

(b) All lines that occur inside a figure have a beginning and an end which define their length. They are preceded and followed by part-loops. (Figure 8)

(c) With the exception of Family 3 figures and some figures in Family 7, the criterion for the length of lines within a figure states that they do not have to be of equal length. Therefore, it is imperative that the judges become familiar with the specific criterion for the length of lines for each figure. For example, the length of the lines in a "Humpty-bump" do not need to be equal, but all four lines in a "Square loop" must be of equal length. (Figure 9)

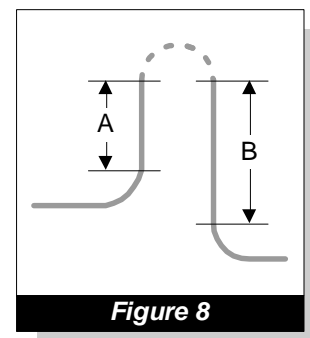

Whenever any kind of roll is placed on an interior line (except when any type of roll follows a spin), the lengths of the two parts of the line before and after the roll must be equal. Judges should take care to judge the symmetry of the length of lines in a figure using only the length of the lines and not by elapsed time taken to fly each segment. This difference in length versus elapsed time is most noticeable in figures where rolls are placed on up-lines. As the aircraft loses airspeed, the time it takes to fly a line after the roll will be greater than the time required to fly the line of the same length before the roll.

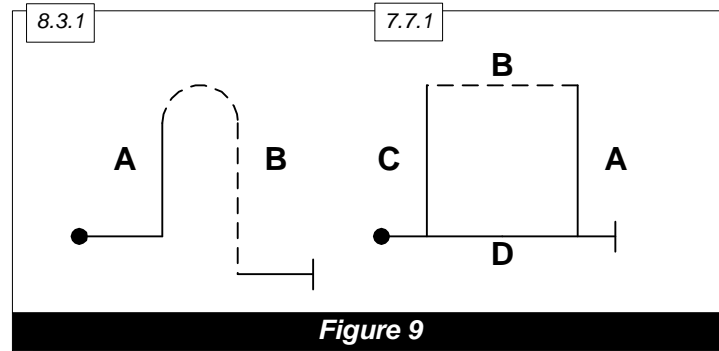

Figure 9

(e) If within a figure two or more lines must be of the same length, an observed variation is penalised by reducing the grade in the following manner: (Figures 10 & 11)

- (i) a visible variation - 1 point deduction;
- (ii) if the lengths vary by 1:2 - 2 point deduction
- (iii) and so forth up to a 3 point deduction.
- (iv) No line before or after roll, 4 point deduction.

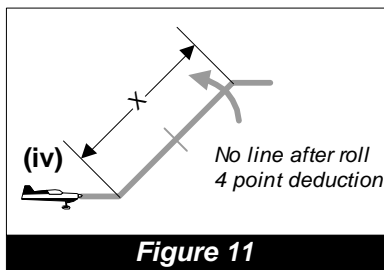

Figure 11

The basis for judging line length is the first line flown. The absence of one of these lines before OR after a roll has to be penalised by 1 additional point. If there are no lines before AND after the roll, the total penalty is two (2) points only.

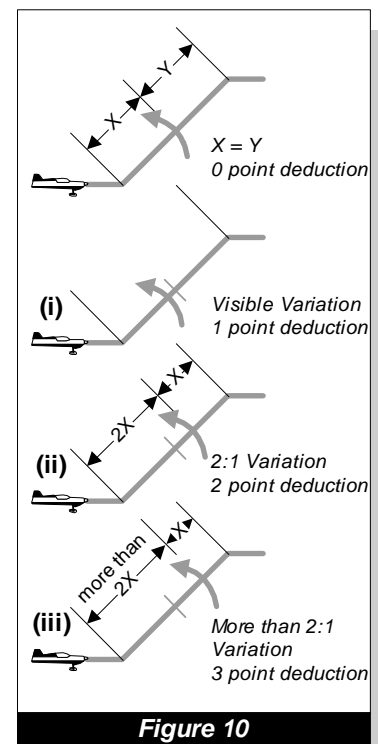

Figure 10

Example: The competitor is to fly a 45 degree up-line with a full roll on the line. However, the airplane is returned to level flight immediately after the roll. The deduction is 4 points: 3 points are deducted because the lines are of vastly different length and another 1 point is deducted because of the absence of one of the lines.

(f) All 90 degree and 45 degree lines are preceded by the execution of a part-loop. Since we have in this part-loop a significant angle-of-attack, the aircraft's attitude in the part-loop will differ from its flight path. Therefore, when the aircraft's attitude reaches the desired line after transitioning from the part-loop, this difference between attitude and flight path will be carried on and will be the same as the angle-of-attack. For this reason, the only criterion for judging in that moment of reaching the desired line is to be the attitude of the aircraft and not its flight path. It would then be very illogical suddenly to change the criterion of judgement from the visible and straight line of attitude to the unrecognizable and curved line of flight path. Therefore, the judging of 90 degree and 45 degree lines can only be based on attitude, not flight path.

Loops and Part Loops

The loop is a figure from Family 7, but part-loops are integral to every other family so it is necessary to discuss the loop before going on to the other families.

(a) A loop must have, by definition, a constant radius. It starts and ends in a well-defined line which, for a complete loop, will be horizontal. For a part-loop, however, such lines may be in any other plane of flight and will be defined by the aircraft's attitude. As the speed changes during execution of a loop or part-loop, the angular velocity around the aircraft's lateral axis also has to change in order to keep the radius constant. When the speed decreases, for example, to half its initial rate, the angular velocity, to keep the same radius, will be reduced by half --this is a fact of physics. Thus, the angular velocity can be an aid for the Judge to gauge the radius -- especially when the angular velocity in the higher part-loop is seen to be faster, as this is a clear indication that the radius is smaller. This aid becomes more important when two part-loops are separated by a line between.

(b) The part-loops of any one figure should all have the same radius, except in Family 1 figures and where indicated in Family 8.1 thru 8.28 and 8.49 thru 8.56. For example, a figure starts on a horizontal line, with a quarter loop next, followed by a vertical line and then another quarter loop. The quarter-loop at the top of the vertical line (Family 1 figure) need not have the same size radius as the quarter-loop at the bottom. However, the top radius must not be a "corner" or very sharp angle. It must have a smooth, distinct and constant radius.

FAI AEROBATIC CATALOGUE FAMILIES

Lines and Angles

Family 1.1 to 1.11 has been fully covered in the preceding section. Note that the figures in Family 1.12 to 1.39 are NOT performed as drawn in the FAI Aerobatic Catalogue. (Figure 12) In each of these figures there are three (four in 1.28 - 1.39) looping components: a one-eighth loop, a three-eighths loop and a quarter loop. (Figure 13) Rolls may be performed on the 45 degree line and/or the 90 degree line, with the part-lines before and after the roll being of equal length. The initial horizontal line and the line at the end of the figure may be flown at different altitudes.

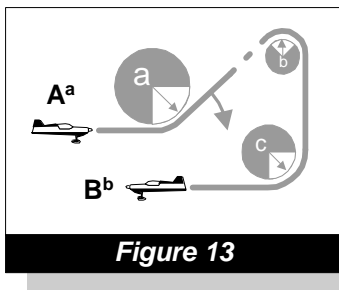
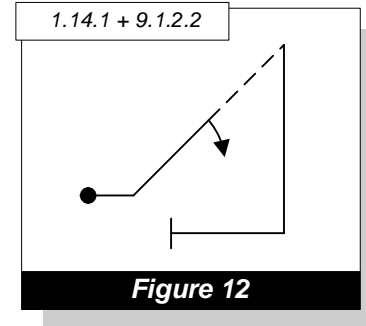

Family 1.12-1.19 as flown. Radii a, b, and c may all be different and entrance altitude "A" can be different from exit altitude "B".

FAMILY 2 - Turns and Rolling Turns

Family 2.1 - 2.2 Turns

Competition turns are not to be confused with standard coordinated turns. In aerobatic competition, a turn is divided into three parts: 1) establishing the bank using a roll on heading; 2) the turn itself; and 3) a roll back to straight and level flight on heading. Let's look at the turn during each of these three parts.

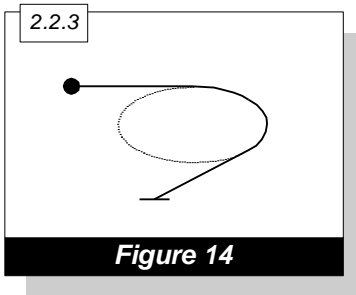

First, the roll to establish the bank. This must be a roll of between 60 and 90 degrees, it must be performed on the entry heading, and the aircraft must maintain a constant horizontal line.

Once the roll is completed and the angle of bank is established, the competitor immediately performs the turn. The turn must maintain the established angle of bank throughout. The aircraft must also maintain horizontal flight. The rate of turn is constant throughout and is NOT wind corrected. Therefore, in wind, a 360 degree turn will not appear as a perfect circle.

As soon as the aircraft is on the exit heading, the competitor performs another roll at a rate equal to the entry roll. Again the aircraft must maintain a constant horizontal line.

Downgrades:

1. The angle of bank established by the initial rolling maneuver must be at least 60 degrees. Anything less is a one (1) point deduction for every five (5) degrees.
2. The angle of bank, once established, must remain constant. Any deviation is a one (1) point deduction for every five (5) degrees of deviation.
3. The rate of roll must be the same for the entry and exit rolls of this figure. Any deviation is a one (1) point deduction.

The aircraft must maintain a constant altitude throughout the figure. Any variation would be either one (1) point for every five (5) degrees of change or 1 point for every 100 feet.

5. The rate of turn must remain constant. Any change would be not more than a one (1) point deduction for each change. Note that the rate of turn may appear to change in a strong wind, when it really isn't changing. The Judge must always keep the wind in mind and give the pilot the benefit of the doubt if there is any question.
6. The aircraft must begin and end on the prescribed heading. Any deviation is a one (1) point deduction for every five (5) degrees of deviation.

Family 2.3 - 2.20 - Rolling Turns

The rolling turn is a figure that combines a turn of a prescribed amount with a roll or rolls integrated throughout the turn.

These rolls may be in the same direction as the turn and are called "rolls in" or "rolls to the inside". They can be rolls in the opposite direction of the turn and are called "rolls out" or "rolls to the outside". Or there can be rolls alternating in and out.

When we say that the rolls are integrated, we are saying that in addition to there being constant rate of turn throughout the figure, there is also a constant rate of roll throughout. Naturally, the one exception to this constant roll rate is the pause when reversing roll directions.

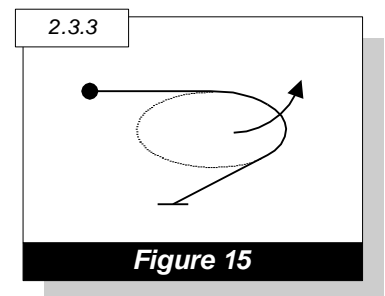

To help visualize the execution of this figure and facilitate a way for the Judge to determine a constant roll rate, let's look at an aircraft performing a 360 degree rolling turn with 4 rolls to the inside from upright (Family 2.10.1). First, on the prescribed entry heading, the pilot executes a turn and simultaneously initiates a roll in the

same direction as the turn. The judge will expect the aircraft to be inverted at 45, 135, 225, and 315 degrees and to be upright at 90, 180, 270 and 360 degrees. At these interim headings, the Judge will NOT downgrade using the one (1) point for five (5) degrees rule but will judge changes in the rate of roll, changes in rate of turn and changes in altitude (see downgrades below). At the end of the figure the aircraft must be wings level and on the prescribed heading.

When a rolling turn is performed with rolls alternating directions, the aircraft must change direction of roll at a wings level attitude. The position of the aircraft in the turn is still only used as an aid to determine if the pilot is varying the rate of roll or turn.

Downgrades:

1. Performing more or fewer rolls than the catalog description calls for results in the figure being zeroed.
2. All rolls in a rolling turn are slow rolls. If a snap roll is performed, the figure is zeroed.
3. Each stoppage of the rate of roll is a deduction of no more than one (1) point.
4. Each variation in the rate of roll is no more than a one (1) point deduction.
5. Each variation in the rate of turn is no more than a one (1) point deduction.
6. Variations in altitude are deducted using either one (1) point for every five (5) degrees or 100 feet of altitude.
7. One (1) point for every five (5) degrees that the aircraft is not in level flight when reversing roll direction.
8. One (1) point for every five (5) degrees of roll remaining when the aircraft has reached its exit heading.
9. One (1) point for every five (5) degrees of turn remaining when the aircraft has completed its last roll.

Family 3 - Combinations of Lines

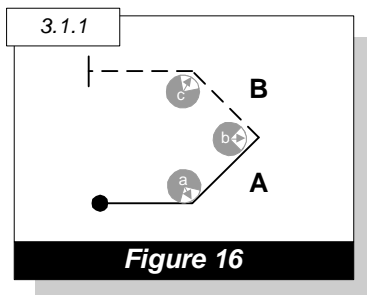

The transition from level flight to 45 degree lines should be at a constant and reasonable 1/8 looping radius. All lines within the figure should be equal in length. The 45 degree transitions in Family 3.1 should have a constant and reasonable radius and not (as drawn) a sharp corner.

Family 5 - Hammerheads

Hammerheads, also referred to as stall turns, are some of the most graceful figures in the FAI catalog. In its most basic form (Figure 17), the figure begins when the aircraft leaves horizontal flight and flies a quarter loop to establish a vertical climb. At the top of the vertical line, the aircraft pivots and establishes a vertical descent, with the figure ending as the aircraft is returned to horizontal flight.

The judging criteria are:

The entry and exit quarter loop radii must be equal. (Figure 17)

The vertical lines, both up and down, must be flown on the zero-lift axis. (see Figure 2)

3. Any deviation from vertical, either up or down, will result in a deduction of one (1) point per five (5) degrees from the zero lift axis.
4. Any added roll(s) must be in the vertical climb or vertical descent and positioned so that the lines before and after the roll are of equal length (Figure 18). For deductions see 8.4.1 (f).

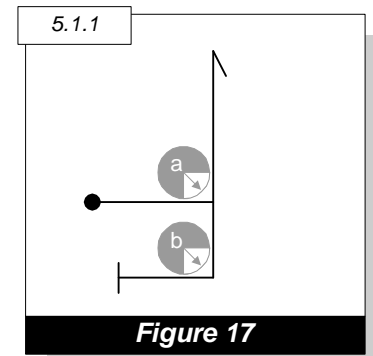

Figure 17

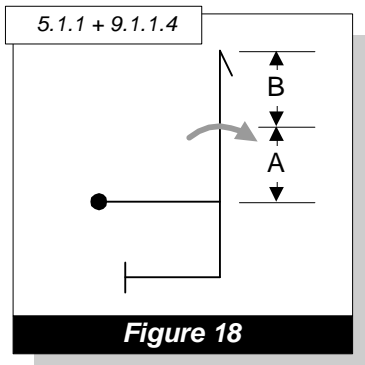

Figure 18

Radius a = b

5. The length of the vertical up and down lines need not be equal. As such, the altitude of the horizontal lines at the start and finish of the hammerhead may be different.
6. During the vertical climb or vertical descent, the wings must remain parallel to the horizon. There will be a one (1) point deduction per five (5) degrees of deviation of the vertical (yaw) axis from horizontal. This deviation is often referred to as "dragging a wing".

Length of line A = B

7. As the aircraft nears the point where it would stop climbing, it must pivot in a plane parallel to vertical.

Ideally, the aircraft pivots around its center of gravity. To avoid a deduction, the aircraft must pivot around an axis point which cannot be farther away from its center of gravity than its wingtips (1/2 wingspan, Pivot Point Range from A to B, Figure 19). The downgrade for this deviation (often referred to as "flying over the top") is one (1) point per half wingspan that the point of rotation exceeds the maximum allowed (Pivot Point B, Figure 19).

8. The rate at which the aircraft pivots around its vertical axis is not a judging criterion.
9. The wings must remain in the vertical geometric plane throughout the turnaround, and the aircraft's attitude before and after the turnaround must be absolutely vertical, with no extraneous movement. There must be no rotation around the longitudinal or lateral axes. If there is movement around any axis other than the yaw axis, often referred to as "torquing" (Figure 20), there is a deduction of one (1) point for each five (5) degrees off axis.

"Torquing" is rotation about the longitudinal axis during turnaround.

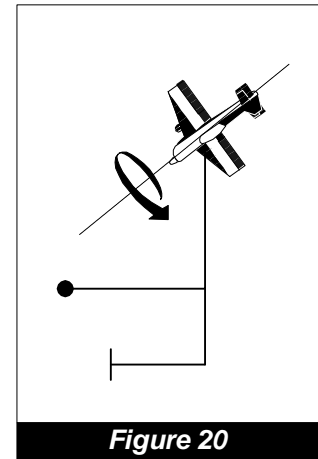

Figure 20

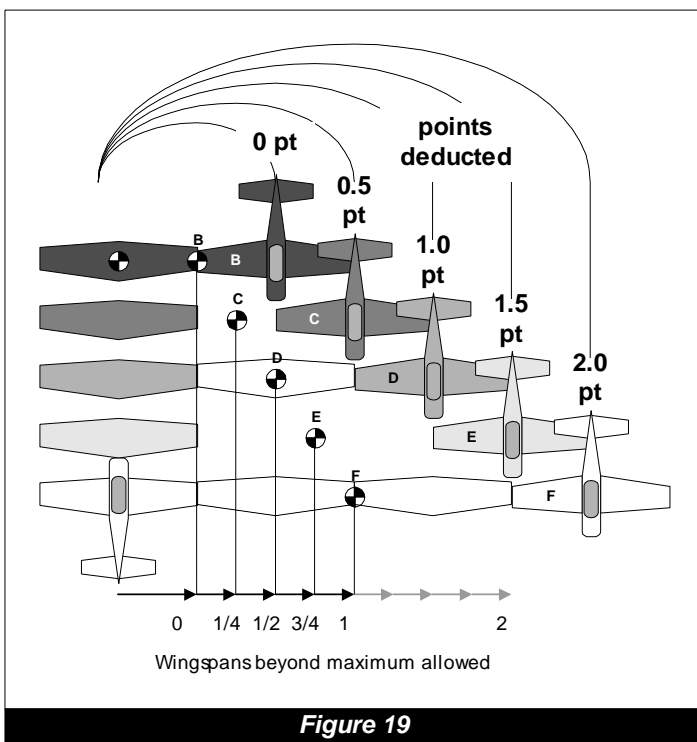

Figure 19

Family 6 - Tailslides

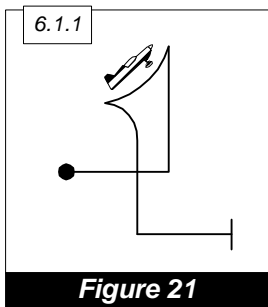

Figure 21

All the criteria of the Hammerhead apply to this figure except, of course, for the maneuver at the top of the vertical climb. At the point when the aircraft stops, it must slide backwards a visible amount (the key here is "a visible amount"). If there is no slide, the grade is zero (0). The aircraft must slide in the vertical plane and not with the nose inclined towards the horizon. A slide of this type must be downgraded by the formula of one (1) point for every five (5) degrees of inclination.

Following the slide backwards, the aircraft must then tip over and fall through to a diving position. Often the nose will swing back or "pendulum" past the vertical after falling through. The figure is not to be downgraded for this, nor downgraded if it does not happen. It is a function of the length of the slide and the type of aircraft, and is not to be considered in grading the figure.

There are two types of tailslides: wheels-down (also called "canopy-up") and wheels up (also called "canopy-down"). The wheels-down tailslide is depicted in the Aresti diagram with a curved solid line at the top of the tailslide symbol. (Figure 21) The wheels-up tailslide is depicted in the Aresti diagram with a curved dashed line at the top of the tailslide symbol. (Figure 22)

This figure must be watched carefully, as the aircraft can fall the wrong way (which is graded a zero) with the correct direction of flight and the proper aircraft attitude still maintained. Wings should stay level with the horizon throughout and not drop during the slide or the fall through. Watch for the aircraft torquing off the correct plane of flight, which must be downgraded. Also watch for "cheating" on the vertical line up in the direction of the slide just prior to sliding. (Figure 23) On this line of the tailslide a non-standard deduction of two (2) points per five (5) degrees of deviation applies. Any "cheating" on the up-line will most likely carry over into the backwards slide as well. Because the slide backwards must also be perfectly vertical, a second deduction would be taken if this deviation from vertical is visible. The entry quarter loop and the exit quarter loop must both have the same radii. The altitude of the entry and exit horizontal lines need not be the same and the figure must not be downgraded if they are different.

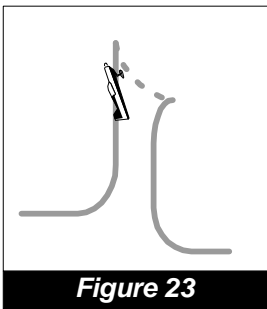

Figure 23

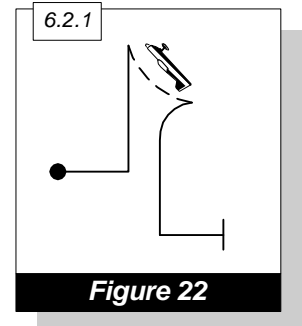

Figure 22

When rolls are combined with Family 6 figures, there must be an equal length of line before and after the roll(s). In the vertical downline, the aircraft must attain a vertical attitude and establish a downline before starting the roll(s).

In summary, the aircraft should make a smooth and steady transition up to vertical flight, the wings should stay level in relation to the horizon, and the aircraft should come to a complete stop in this attitude. After sliding backward a visible amount, it should fall through in the appropriate direction without dropping a wing or the nose moving off axis, and recover on the same plane as that of entry. After completion of this, it should again project the 90 degree down line before transitioning into horizontal flight with a quarter loop of radius equal to the entry quarter loop.

Family 7 - Loops, Vertical S's, and Figure 8's

The size of a loop is not a grading criteria. It will vary according to the flight characteristics of the aircraft. A large loop is not graded any higher or lower than a small loop. But any variation to the radius will downgrade these figures.

Family 7.1 - 7.4 - Half-Loops With Rolls

The half-loops in this sub-family must be of a constant radius and wind-corrected to appear as a perfect half circle (see full loops discussion below).

When a half-loop is preceded by a roll or rolls, the half-loop follows immediately after the rolls without any visible line. Drawing a line requires a downgrade of at least two (2) points depending on the length of the line drawn. Should the half-loop begin before the roll is completed, the Judge must downgrade the figure one (1) point for every five (5) degrees of half-loop flown on which the roll was performed.

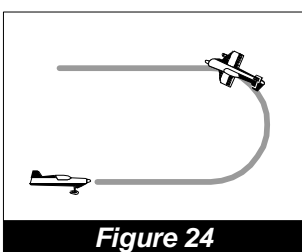

Figure 24

Aircraft rolls five degrees early before reaching horizontal flight. Deduction of one point is given.

The half-loop followed by a roll is also flown with no line between the half-loop and roll. Again, drawing a line requires a downgrade of at least two points depending on the length of the line drawn. Should the roll begin before the half-loop is completed, the Judge must downgrade the figure one (1) point for every five (5) degrees of half-loop on which the roll was performed. (Figure 24)

Family 7.5 - 7.6 - Full Loops

All full loops must appear perfectly round to the Judge. This means that they must be wind corrected to have a constant radius. This wind correction is only with regards to the roundness of the loop and not for the effect of any crosswind on the figure. Therefore, no deduction is given if the finish point is displaced relative to the start point in a direction perpendicular to the plane of the loop. Full loops must also begin and end at the same altitude or they will be downgraded. (Figure 25)

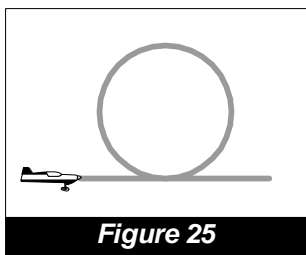

Figure 25

Loops must be flown with no visible crabbing and wings must be level at all times. The one (1) point for every five (5) degrees rule holds for both these cases.

If there is a roll or rolls at the apex of the loop, it must be centered in the loop and flown on the arc of the loop itself. Flying the roll on a line at the apex of the loop is at least a two (2) point downgrade. If the roll is not centered, it must be downgraded one (1) point for every five (5) degrees of the arc that it is off center.

To better quantify deductions for irregularity of the radius of looping figures, the Judge divides the loop into quadrants. Any variation in the radius from one quadrant to the next can be downgraded a fixed number of points depending on the magnitude of the variation.

The goal of each Judge is to develop a reproducible method to judge all loops with the same criteria.

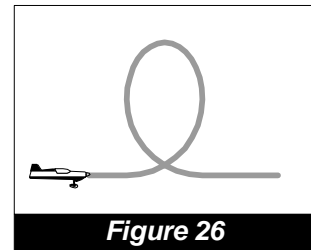

Figure 26

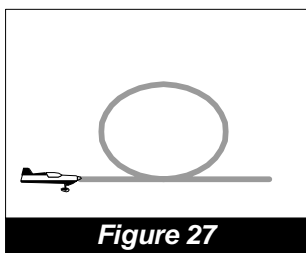

Figure 27

In judging loops, a common error is for the vertical diameter of the loop to be larger than the horizontal diameter. This is often called an "L" shaped loop. (Figure 26) Less common are loops with a horizontal diameter greater than the vertical. This is called an egg-shaped or pumpkin-shaped loop. (Figure 27) Another common error is in varying the radius of the final quadrant performing an "e" shaped loop. (Figure 28)

Whatever method is used, standard downgrades should be applied for each of these errors. Additional downgrades should be applied based on the magnitude of variation.

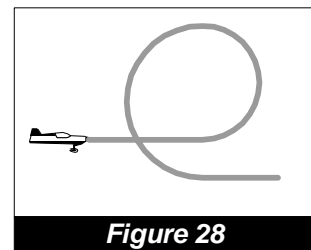
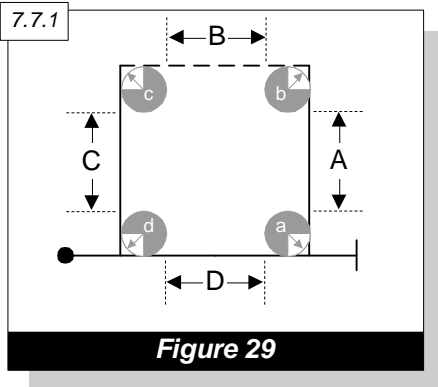

Figure 28

Family 7.7 - 7.10 - Square, Diamond and Octagon Loops

Square and Octagon loops are flown as hesitation loops with lines of equal length and partial loops with equal radii. All horizontal lines are judged on flight path and vertical and diagonal lines are judged based on aircraft attitude. As such, except in a windless condition, the judge should never expect to see these figures closed. They will always be driven by the wind. Square and Octagon loops are not considered complete until the last horizontal line is drawn equal to the length of the first line of the figure. (Figure 29)



Radii $a = b = c = d$
Line Length $A = B = C = D$
Figure is not complete until $D = A$

Where rolls are flown on the Square or Diamond loops, they must be centered on the line.

Aids for judging all hesitation loops are that a good performance will contain changes of angular velocity in all the partial loops, and variations of time taken to draw the length of each interior line, which also varies according to the aircraft's speed. The rhythm of all these partial loops is a help for judging. A frequently seen error in hesitation loops is for the aircraft to overshoot the partial loop and then have to bring the nose back to correct the attitude. This must be downgraded by one (1) point for every five (5) degrees.

Family 7.11 - 7.12 - Vertical S's

These figures are accomplished with two joined half-loops flown in opposite directions. (Figure 30) Look for both half-loops to be the same size and perfectly round. The half-loops should be a continuous looping figure when there is no roll between the half-loops. When a roll is performed between the half-loops, there is no line before or after the roll. However, the roll is flown on a horizontal line which begins as soon as the first half-loop is finished. As soon as the roll is finished, the next half-loop must begin immediately. Adding a line at either of these points is at least a two (2) point deduction depending on the length of the line.

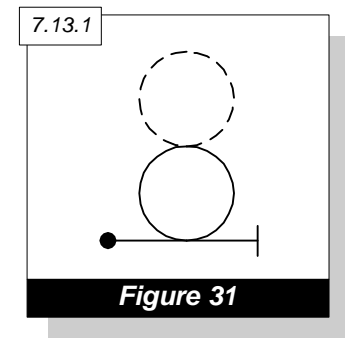
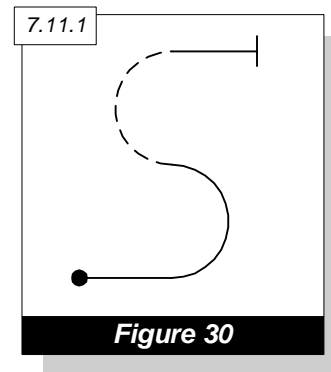

Family 7.13 - 7.18 - Vertical 8's

These figures are performed by flying two loops, one above the other. Sub-family 7.13-7.16 is composed of two loops, both above or both below the entry altitude. Sub-family 7.17 - 7.18 is composed of one loop above and one loop below the entry altitude. In either case the entry and exit altitudes must be the same.

These figures may be combined with various types of half rolls. When a roll is performed between the loops, there is no line before or after the roll. However the roll is flown on a horizontal line which begins as soon as the first loop is finished. As soon as the roll is finished, the next loop must begin

immediately. Adding a line at either of these points is at least a two (2) points deduction depending on the length of the line. These figures are to be graded using the same criteria as full loops. Additionally, both loops must be of the same size. Unless there is a roll between the loops, they must be directly above one another. (Figure 31)

Family 7.19 - 7.22 - Partial 8's

Sometimes referred to as "Goldfish", the entry, $3/4$ loop, and exit radii in these figures must all be identical. The entry and exit lines are judged with reference to the 45 degree attitude, not flight path. Any rolls on the 45 degree lines must be centered on that line. It is not required that the lengths of the 45 degree lines bear any strict relation to the diameter of the three quarter loop. That is, the entry and exit altitudes need not correspond to the altitude limits of the loop. (Figure 32)

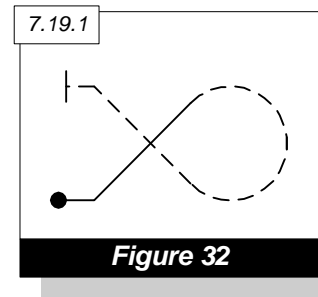

Family 7.23 - 7.30 - Horizontal 8's

Both loops must be the same size and the lines between the loops flown at exactly 45 degrees attitude. This means that only if there is no wind will they intersect at the exact midpoint of the 8. If there are rolls of any variety, they will only occur on the 45 degree lines and be positioned so that the lines before and after the roll are of equal length. For deductions see 8.4.1(f).

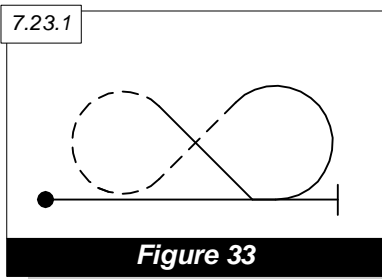

The start and finish of the figure and the bottoms (or tops if the figure is reversed) of the two loops must be at the same altitude. However, if there are multiple rolls flown on the last 45 degree line, that line may project above or below the looping portions and exit at a different altitude than the entry altitude of the figure.

All part-loops between 45 degree and horizontal lines should have the same radii as the loops of the Horizontal 8 itself. A common fault is to fly these part-loops as drawn in the catalog symbol, which means with a corner.

This must be downgraded. (Figure 33)

Family 7.31 - 7.38 - Combination 8's

Besides possessing the unique characteristic of containing three 45 degree lines on which rolls may potentially be placed, this family can be thought of as two linked Partial 8's (sub-families 7.19-7.22).

Radii of the entry/exit $1/8$ loops and the two $3/4$ loops must all be equal. Each of the 45 degree lines may be of different lengths, but any rolls placed on them must be centered. The two $3/4$ loops need not occur at the same altitude, nor is there any strict relationship between the horizontal entry/exit altitudes and the altitude limits of the two $3/4$ loops. (Figure 34)

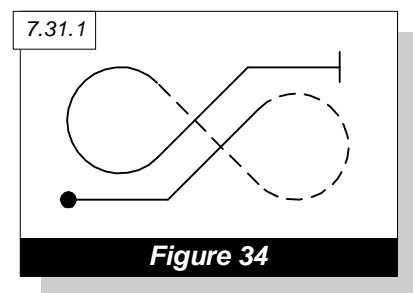

Family 8 - Combinations of Lines, Loops and Rolls

Although some of the figures in this Family appear to be exotic, there are no new judging criteria for these figures. These figures are combinations of horizontal, vertical and 45 degree lines as well as partial loops of varying degrees. The judging criteria for these lines and loops are unchanged. What is left to discuss are the judging criteria for the combinations of these lines and loops.

Family 8.1 - 8.28 - Humpty Bumps

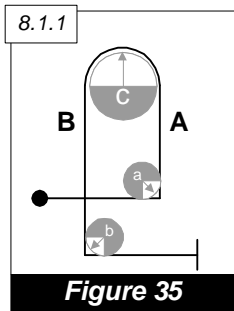

Figure 35

Radius $a = b$ but c does not have to equal a or b .

These figures, whether vertical or performed with 45 degree lines, are judged as combination of lines and loops. For all these figures, the radii of the first and last partial loop must be equal. However, the half loop in the middle of the figure can be of a different radius. These half loops must still have a constant radius from the time they depart the vertical or 45 degree line. This requires a change in angular velocity during the half loop.

The lines in these figures may be of different lengths, and therefore the entry and exit altitudes of these figures can be different. Rolls on any of these lines must be centered.

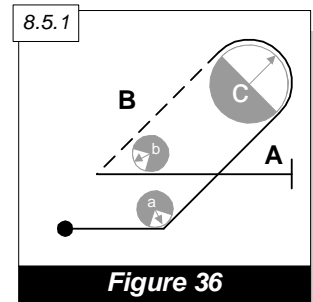

Figure 36

Length of line A does not need to equal B.

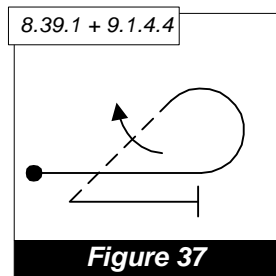

Figure 37

Family 8.29 - 8.48 - 7/8 Loops, Reverse Half Cubans, 3/4 Loops, Half Cubans

In these figures, all partial loops must have the same radii. The rolls on vertical and 45 degree lines must be centered. Angles drawn in the FAI Aerobic Catalogue, such as in figure 8.5.29, are to be flown as partial loops. In the case of this figure, a 5/8 loop is flown followed by a 45 degree line down with an optional 360 degree roll and then a 3/8 loop back to upright horizontal flight.

Family 8.49 - 8.56 - Multiple Looping Combinations

When 1/2 and 3/4 loops join each other in these sub-families, their radii must be equal and there is no line between the loops. A line drawn would be a minimum two (2) point deduction depending on the length of the line. In sub-family 8.53 - 8.54, where a 1/2 roll is depicted between the 1/2 and 3/4 loops, there is no line before or after the roll. However the roll is flown on a horizontal line which begins as soon as the first partial loop is finished. As soon as the roll is finished, the next partial loop must begin immediately. Adding a line at either of these points is a minimum two (2) point deduction depending on the length of the line. The final exception is the 1/4 loop that returns the aircraft to horizontal flight, which should have a reasonable radius, but need not match the other looping radii.

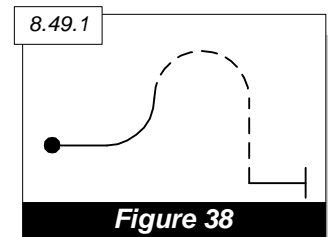
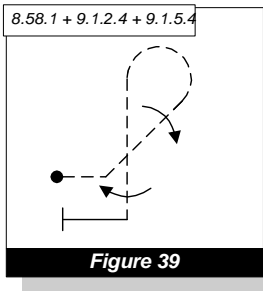

Figure 38

Family 8.57 - 8.72 - Teardrops

In these figures, all partial loops must have the same radii. The rolls on vertical and 45 degree lines must be centered. Angles drawn in the FAI Aerobic Catalogue, such as in figure 8.58.2., are to be flown as partial loops. In the case of this figure, a 3/8 loop is flown followed by an inverted 45 degree line up with an optional



360 degree roll. Then an outside 5/8 loop is flown and a vertical line down on which there may be another 360 degree roll. Finally a quarter loop is flown, bringing the aircraft back to upright horizontal flight. (Figure 39)

Family 9 - Rolls and Spins

Rolls may be performed on horizontal, 45 degree or 90 degree lines; on complete loops; between part-loops; between part-loops and lines; and following spin elements.

They may be 1/4, 1/2, 3/4 or a full 360 degrees in their rotation, up to two consecutive full rolls. Additionally, slow rolls may be flown in combination with turns as prescribed in Family 2 (Rolling Turns).

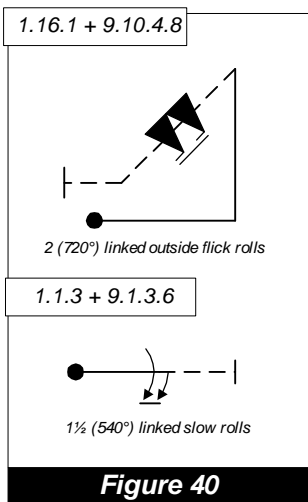

In all cases, the same criteria apply: the rate of roll must be constant throughout the roll(s). The aircraft should continue to project, during the rolling portion, the prescribed plane and direction of flight.

Multiple rolls may be linked, unlinked, or opposite.

(1) When rolls are in continuous rotation, the tips of the symbols are linked by a small line. When flying linked rolls there is no pause between them. (Figure 40)

(2) Unlinked rolls must be of different types, the two types being defined as follows:

- (i) Aileron rolls (slow rolls and hesitation rolls)
- (ii) Snap rolls (positive and negative)

No line links the symbols, though their tips are drawn pointing in the same direction (i.e., on the same side of the line). They must have a brief but perceptible pause between them and they are to be flown in the same direction of rotation. (Figure 41)

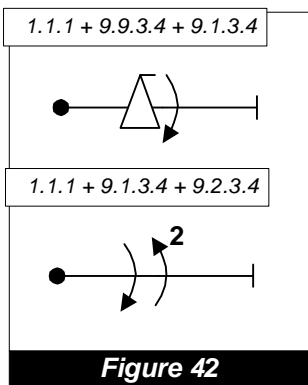
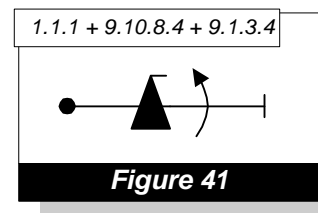

(3) Opposite rolls may be either of the same or different type. In opposite rolls, the tips of the symbols are drawn on opposite sides of the line, indicating they are to be flown in opposite directions of rotation. The pilot may elect to fly the first roll in either direction, but the second roll must be opposite direction to the first. Opposite rolls, including those in rolling turns, should be flown as one continuous maneuver - the brief check between opposite rotations should be minimal. (Figure 42) If the two rolls are of the same type, they must be flown in opposite directions if they are not linked.

(4) Either aileron or flick rolls may follow spin elements (Family 9.11 or 9.12). When a spin and a roll are combined on the same vertical downline they will always be unlinked; may be flown in either the same or opposite direction, as shown by the position of the tips of the symbols on the Form B or C; and the

combination may not exceed two rotational elements. (For example, it would be illegal to combine two opposite direction aileron rolls with a spin element.)

Family 9.1 - Slow Rolls

The penalty for varying the rate of roll is one (1) point per variation. Any stoppage in the slow roll that could result in its being considered a hesitation roll, would zero (0) the figure.

The finish of the roll must be as crisp and precise as possible. Coming to a slow finish in fact represents a change in the rate of roll and should be penalised accordingly.

The wings must stop precisely after the desired degree of rotation and not go past the stop point and then return. This is referred to as "bumping the point". A deduction of 0.5 point to one (1) point is given depending on the severity of the "bump".

Family 9.2 - 9.8 - Hesitation Rolls

These rolls are judged on the same criteria as the slow roll, only the aircraft stops rotation during the roll for a pre-stated number of times, i.e., 2, 4 or 8. The rate of the roll and the rhythm of the hesitations must be constant throughout with the aircraft projecting the pre-stated plane and direction of flight.

The pauses will be of identical duration and the degree of rotation correct between each pause: 180 degrees, 90 degrees, or 45 degrees. Each pause of a hesitation roll must be clearly recognizable in every case, but it is especially important that in poor visibility or at high altitude, the competitor pauses long enough to make them recognizable to the Judges. If a pause is not recognizable, the figure is graded a zero (0).

For hesitation rolls, the second digit in the catalog number indicates the number of points: Family 9.2 is 2-point rolls; Family 9.4 is 4-point rolls; and Family 9.8 is 8-point rolls.

Family 9.9 - Positive Snap Rolls

Snap rolls represent one of the greatest challenges to judges. This is primarily due to two factors: (1) the "snapping" characteristics of different types of aircraft are unique; and (2), snap rolls are a high energy maneuver that occur very quickly. Snaps happen so fast, in fact, that it is virtually impossible for a judge to determine the exact order in which events occur, especially at the beginning of the snap. There are no criteria, therefore, for seeing nose and wing movement initiated at the same time as with the other autorotation family, Spins.

The judge must see two things to determine that a snap roll has occurred. The nose must depart the flight path in the correct direction and autorotation must be initiated. If the judge does not observe both events, the figure must be given a zero (0).

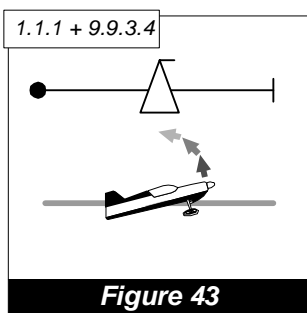

For a positive snap roll, the nose must move away clearly and unambiguously from the wheels. (Figure 43) This puts the aircraft's wings near the critical angle-of-attack. Either shortly after the nose moves, or simultaneously with the nose movement, the aircraft must be seen to yaw around its vertical axis, thus initiating a stall of one wing and subsequent autorotation. If any movement about the longitudinal (roll) axis is observed before the autorotation starts, the figure is downgraded one (1) point per five (5) degrees of roll.

Throughout the snap roll, the main axis of the snap roll's rotation must be in the correct plane and direction of flight. However, the type of motion (angle-of-attack and angular velocity) displayed around the main axis of autorotation differs between aircraft types (much as each type of aircraft has different spin characteristics). If the character of the snap roll changes during the

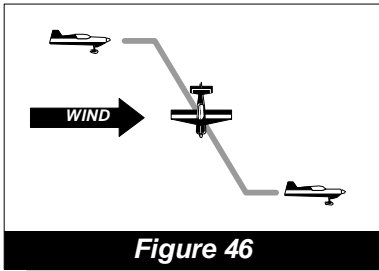

figure, the figure is downgraded. (see Family 9.1) A changing rate of rotation or the nose moving more onto the flight path (like a slow roll) is the most often observed change in character. But for all aircraft types, the criteria for stopping the snap roll is the same: the attitude before starting the snap roll and in the instant of stopping it must be identical and must correspond to the geometry of the basic figure on which the snap roll is performed.

Snap rolls must be observed very carefully to ensure that the competitor is not "aileroning" the aircraft around its longitudinal axis. Aerobatic aircraft with very high rates of roll can occasionally fool a judge in the execution of snap rolls. The movement of the aircraft's nose departing the flight path prior to autorotation is a good clue to the proper execution of a snap roll. As always, the competitor is given the benefit of the doubt, but if a judge is certain that a proper snap roll has not been executed, a zero (0) is given. Another common error is for the aircraft to autorotate, but to not stay in autorotation until the end of the figure. In this case, a deduction of one (1) point for each five (5) degrees of rotation remaining when the autorotation stops must be made. If autorotation ends with more than 45 degrees of rotation remaining, even if the roll is completed with aileron, the snap roll is zeroed.

Family 9.10 - Negative Snap Rolls

For negative snap rolls, all criteria stated for positive snap rolls apply except, of course, that the aircraft is in a negative rather than positive angle-of-attack during autorotation. Therefore, in a negative snap roll the nose of the aircraft will move toward the wheels as it departs the line of the aircraft's flight path. (Figure 44) This direction of motion must be observed very carefully, since it is the defining characteristic that differentiates a negative snap roll from a positive snap roll. As with positive snap rolls, if the nose does not move in the correct direction, it is not a negative snap roll and the figure must be given a zero (0).

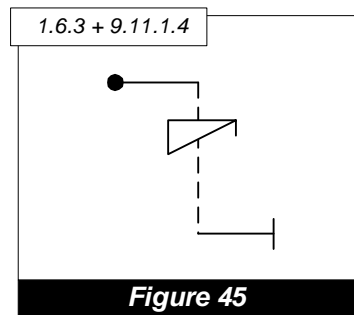
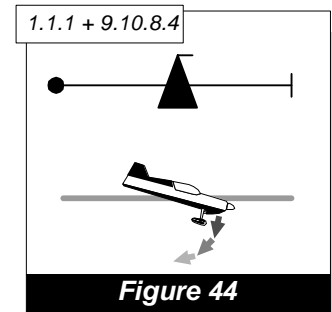

Family 9.11 and 9.12 - Spins

All spins begin and end with horizontal flight. In order to spin, the aircraft must be completely stalled in horizontal, level flight from a clearly visible horizontal line before the stall. When the aircraft stalls, the center of gravity will drop from wings-level horizontal flight. It should be noted that an aircraft has forward inertia as the aircraft decelerates through stall speed.

This appearance is more pronounced when the figure is performed downwind, and is enhanced when performed into the wind. This change in appearance is not a grading criteria. (Figure 46)

One Turn Spin figure as drawn

Normal Spins (upright spins entered from upright flight, or inverted spins entered from inverted flight): When the aircraft stalls, the nose will fall and at the same time the wing tip will drop in the direction of the spin. Failure to achieve this should be considered a "forced entry" and downgraded one (1) point per five (5) degrees of deviation.

Effect of wind and forward inertia on flight path during one turn spin (effect exaggerated)



Cross-Over Spins (inverted spins entered from upright flight, or upright spins entered from inverted flight): To accomplish a cross-over spin, the aircraft must first stall in its initial attitude (upright or inverted) and then transition to a stall in the opposite attitude (inverted or upright) before autorotation starts. If the aircraft is rotating before the second stall occurs, the figure must be given a zero (0). It should be noted that the attitude at which the second stall occurs is very different for each aircraft. The aircraft does not necessarily need to reach a very nose-low attitude to achieve the second stall.

Both Normal and Cross-Over Spins: After completion of the prescribed number of turns, the aircraft must stop rotating precisely on the pre-stated heading, then a 90 degree down, wings-level attitude must be seen. Grading criteria for the basic figure being flown then resumes. If a roll follows a spin, there should be a brief, but perceptible pause (similar to unlinked rolls) between the spin and the roll. Because there is no vertical line before the spin, there is no criteria to center either a spin element alone or a spin-roll combination on the vertical downline. Be alert for early stopping of the stalled autorotation followed by "aileroning" to the pre-stated heading. In this case, a deduction of one (1) point for every five (5) degrees of "aileroning" must be applied. For example, in a one-turn spin the autorotation is observed to stop after 345 degrees of rotation and the ailerons are used to complete the rotation. The highest score this spin could receive is a 7.0.

No account is to be taken of the pitch attitude of the aircraft during autorotation, as some aircraft spin in a nearly vertical pitch attitude while others spin quite flat in conventional spins. Speed of rotation is also not a judging criterion.

If the aircraft never stalls, it is apparent that it cannot spin, and a zero (0) must be given. You will see "simulated" spins where barrel rolls or snap rolls are offered as spin entries. In both cases, the flight path will not be downward. In all of these cases, the figure will be zeroed.

In all spins the grading criteria are:

1. A clean breaking stall in horizontal flight.
2. Fully-stalled autorotation.
3. Stopping on pre-stated heading.
4. 90 degrees down, wings-level attitude after stopping on heading.
5. A constant, reasonable quarter-loop radius back the horizontal flight.

POSITIONING

Positioning is scored in one of two ways: mechanically, by means of a tracking device; or by the individual judges. When it is scored by a judge, a lower K factor is applied.

Positioning refers to the placement of the figures in relation to the X and Y axes. A sequence should be flown within the aerobatic zone so that the individual figures are symmetrically placed in relation to the X and Y axes. The positioning mark will be determined by the percentage of mispositioned figures. For example, if 4 figures



out of 16 are noted out of position, 25% or 2.5 points will be deducted from 10, giving a maximum positioning mark of 7.5.



APPENDIX 2 TO CIVA REGULATIONS (PART ONE)

Calculation of scores for an aerobatic programme using the Tarasov-Bauer-Long-Penteado method (TBLP) in a figure by figure mode.

The rating of a pilot performance for a given flight is an amount of points arising from two separate sources:

Quality evaluation of flown figures or flight positioning with a score given by judges observing the flight, on a scale ranging from 0 to 10.

B) Penalties arising from height or time infringements and/or interruptions of the program sequence and other disciplinary actions.

The scores from (A) are subject to random and systematic errors due to the inevitable lack of exactness of judging, and the Purpose of the TBLP system is to reduce the effect of those errors to a minimum.

The penalties from (B) are not subject to the same errors and are simply subtracted from the scores results (A) after they have been calculated as described below.

The calculation of scores is performed in 2 separate phases:

PHASE I

Scores assigned to individual figures on each flight are statistically treated to remove coarse deviations from a calculated expectation range. This range is centered at 1.4 times the individual pilot-figure Standard Deviation and the removal is performed in a continuous weighted fashion from 1.2 SD (no removal) to 1.6 SD (full removal). The score is either taken with its original value or slowly changed to a value that represents the average of the scores of the other judges.

Pilots or Judges with all scores equal zero will be considered as non-existent for calculation purposes.

Let:

- G(p,j,f) = Figure Grade given to the p-th pilot, f-th figure by the j-th judge.
- Np = Total number of pilots in the flight with at least one figure score bigger than zero.
- nj = Total number of judges on the panel with at least one figure score bigger than zero.
- nf(p) = Total number of figures for the p-th pilot.
- Rg(p,j) = Raw grade for the p-th pilot, j-th judge.
- Ga(p,j) = Grade average for the p-th pilot, j-th judge.
- Ja(j) = Average of Raw grades given by the j-th judge.
- Js(j) = The mean-square difference between Raw grades given by the j-th judge and his average Ja(j).
- A = The average of all Raw grades given by all judges.
- S = The mean square difference between all Raw grades and the average A.
- Acf(j) = Average correction factor for the j-th judge.
- Scf(j) = Scatter correction factor for the j-th judge.
- Ng(p,j,f)= Rescaled grade corrected to each p-th pilot, j-th judge and f-th figure.
- Fa(p,f) = Pilot averages on each figure (for all judges).
- Fs(p,f) = Pilot scatters on each figure
- Fssd(p,f)= Pilot Std.Deviation on each figure (Sqrt Fs(p,f)).
- Fd(p,f) = Figure displacement in Sd.Dv. units.
- Fk(p,j,f)= Figure progressive deletion limit in standard deviation units. This is the external size of the acceptance window for grade displacements.
- Fwm(p,j,f)= Figure weighted average multiplier (0 to 1).



$F_t(p,f)$ = Corrected figure grade.

$R(p,j)$ = Corrected raw score. Sum of corrected figure grades multiplied by respective K factors.

Compute the Raw grade for the p-th pilot and j-th judge,

$$Rg(p, j) = \sum_{f=1}^{nf} G(p, j, f)$$

Compute the Grade average for that p-th pilot and j-th judge.

$$Ga(p, j) = \frac{1}{nf(p)} \sum Rg(p, j)$$

Compute the j-th judge average,

$$Ja(j) = \frac{1}{np} \sum_{p=1}^{np} Rg(p, j)$$

Compute the j-th judge mean-square scatter,

$$Js(j) = \frac{1}{(np-1)} \sum_{p=1}^{np} [Rg(p, j)^2 - np Ja(j)^2]$$

Compute the flight average,

$$A = \frac{1}{nj} \sum_{j=1}^{nj} Ja(j)$$

Compute the flight mean-square scatter,

$$S = \frac{1}{np nj-1} \sum_{j=1}^{nj} [\sum_{p=1}^{np} (Rg(p, j)^2) - np nj A^2]$$

Compute the average correction factor,

$$Acf(j) = \frac{1}{Ja(j)} A$$



Compute the Scatter correction factor,

$$Scf(j) = \frac{1}{\sqrt{J_s(j)}} \sqrt{S}$$

Compute the rescaled figures grades,

$$Ng(p, j, f) = [G(p, j, f) - Ga(p, j)] Scf(j) + Ga(p, j) Acf(j)$$

Rescaled grades for all figures in all judges now have similar averages and scatters (A and S). The rescaled figure grades are then weighted and progressively adjusted before being transformed into a raw score for that p-th pilot and j-th judge. This procedure will remove individual figure grades that are presumed to be unrepresentative of the pilot's performance.

Compute the p-th pilot, f-th figure Rescaled Grades average of all judges,

$$Fa(p, f) = \frac{1}{n_j} \sum_{j=1}^{n_j} Ng(p, j, f)$$

Fa(p) is the estimated mean value of the hypothetical Gaussian population from which the Grades were drawn.

Compute the p-th pilot, f-th figure mean square scatter,

$$Fs(p, f) = \frac{1}{n_j - 1} \sum_{j=1}^{n_j} [Ng(p, j, f)^2 - n_j Fa(p, f)^2]$$

Compute the p-th pilot, f-th figure Standard Deviation,

$$Fssd(p, f) = \sqrt{Fs(p, f)}$$

$$\text{If } Fssd(p, f) > 0.03Fa(p, f) \text{ then, } Fssd(p, f) = 0.03Fa(p, f)$$

Compute the p-th pilot, j-th judge, f-th figure, displacement in units of Fssd(p,f),

$$Fd(p, f) = \frac{Abs[Ng(p, j, f) - Fa(p, f)]}{Fssd(p, f)}$$

Compute the maximum window acceptance values expressed in units of Fssd(p,f),

$$Fk(p, j, f) = 1.6 - Fd(p, j, f)$$

$$\text{If } Fk(p, j, f) < 0 \text{ then, } Fk(p, j, f) = 0$$



Compute the Weighted average multiplier in values expressed in units of Fssd(p,f)

$$Fwm(p, j, f) = \frac{1}{0.4} Fk(p, j, f)$$

If $Fwm(p, j, f) > 1$ then, $Fwm(p, j, f) = 1$

Compute the corrected final figure value.

$$Ft(p, j, f) = [G(p, j, f) - Fa(p, f)] Fwm(p, f) + Fa(p, j, f)$$

Compute the corrected raw score for the p-th pilot, and j-th judge, to be used in the next phase,

$$R(p, j) = \frac{\sum_{f=1}^{nf(p)} Ft(p, j, f) Kf(p, f)}{nf(p)}$$

PHASE II

The calculated corrected raw scores are now used in a second computation. The term raw score now, refers to the corrected raw scores $R(p,j)$ obtained with the previous calculations.

Again, pilots or judges with all raw scores equal zero will be considered as non-existent for calculation purposes.

Let:

- $R(p,j)$ = Raw score calculated for the p-th pilot and the j-th judge.
- Np = Total number of pilots flying the program with at least one raw score bigger than zero.
- Nj = Total number of judges on the panel with at least one raw score bigger than zero.
- $Ja(j)$ = Judge average: the average raw score given by the j-th judge.
- $Js(j)$ = Judge scatter: the mean-square difference between raw scores given by the j-th judge and his average score $Ja(j)$.
- A = Overall average: the average of all raw scores given by the panel of judges in that flight.
- S = Overall scatter: the mean square difference between all raw scores and the average A .
- $N(p,j)$ = Rescaled score corrected to each p-th pilot and j-th judge.
- $Pa(p)$ = Pilot average: the p-th pilot average rescaled score.
- $Ps(p)$ = Pilot scatter: the mean-square difference between the p-th pilot rescaled scores $N(p,j)$ and their averages $Pa(p)$.
- $Psd(p)$ = Pilot Standard Deviation $Sqrt Ps(p)$.
- $D(p,j)$ = Displacement of the j-th judge rescaled score from $Pa(p)$ in units of Standard Deviation $Sqrt Ps(p)$.
- $K(p,j)$ = Progressive deletion limit in standard deviation units. This is the external size of the acceptance window for score displacements.



- Wm(p,j) = Weight average multiplier factor for each judge in a pilot (varies from 0 to 1).
 Wd(p) = Total weight average sum for all judges scores on the p-th pilot.
 T(p) = Final TBLP average score for the p-th pilot.

The first step in the procedure is to rescale the raw scores in order to minimize errors arising from differences in judging style.

Compute the j-th judge average raw score,

$$J_a(j) = \frac{1}{n_p} \sum_{p=1}^{n_p} R(p, j)$$

Compute the j-th judge mean-square raw score scatter,

$$J_s(j) = \frac{1}{(n_p-1)} \sum_{p=1}^{n_p} [R(p, j)^2 - n_p J_a(j)^2]$$

Compute the overall event average,

$$A = \frac{1}{n_j} \sum_{j=1}^{n_j} J_a(j)$$

Compute the overall event scatter,

$$S = \frac{1}{(n_p n_j - 1)} \sum_{j=1}^{n_j} \sum_{p=1}^{n_p} [(R(p, j))^2 - n_p n_j A^2]$$

Compute the rescaled scores,

$$N(p, j) = \left[\frac{R(p, j) - J_a(j)}{\sqrt{J_s(j)}} \sqrt{S} \right] + A$$

Rescaled scores for all judges now have the same average and scatter (A and S). The rescaled scores are now progressively weighted before averaging, to remove outliers that are presumed to be unrepresentative of the pilot performance.

Compute the pilot average rescaled score,

$$P_a(p) = \frac{1}{n_j} \sum_{j=1}^{n_j} N(p, j)$$

Pa(p) is the estimated mean value of the hypothetical Gaussian population from which the scores were drawn.



Compute the pilot mean-square scatter,

$$Ps(p) = \frac{1}{(n_j-1)} [E N(p, j)^2 - n_j Pa(p)^2]$$

Compute the pilot Standard Deviation,

$$Psd(p) = \text{Sqrt } Ps(p)$$

$$\text{If } Psd(p) < 0.03Pa(p) \text{ then, } Psd(p) = 0.03Pa(p)$$

Compute the judges scores displacements in units of pilot Standard Deviation,

$$D(p, j) = \frac{\text{Abs}[N(p, j) - Pa(p)]}{Psd(p)}$$

Compute the maximum window acceptance values in units of pilot standard deviation,

$$K(p, j) = 1.2 - D(p, j)$$

$$\text{if } K(p, j) < 0 \text{ then, } K(p, j) = 0$$

Compute the average weight multiplier for the judges,

$$Wm(p, j) = \frac{1}{0.4} K(p, j)$$

$$\text{if } Wm(p, j) > 1 \text{ then, } Wm(p, j) = 1$$

Compute the total average weight for all judges on each pilot,

$$Wd(p) = E_j Wm(p, j)$$

Compute the final TBLP scores,

$$T(p) = \frac{1}{Wd(p)} E_j [N(p, j) Wm(p, j)]$$

Penalty Points arising from category (B) are then subtracted from the results calculated above. The result is the pilot final score for the flight. If the final score is negative, a zero will be used for that pilot on that flight.

APPENDIX 3 TO CIVA REGULATIONS (PART ONE)
LIST OF FIGURES FOR PROGRAMMES 2 AND 3

NOTE: Unlinked and opposite rolls permitted only on horizontal lines

1. LINES & ANGLES

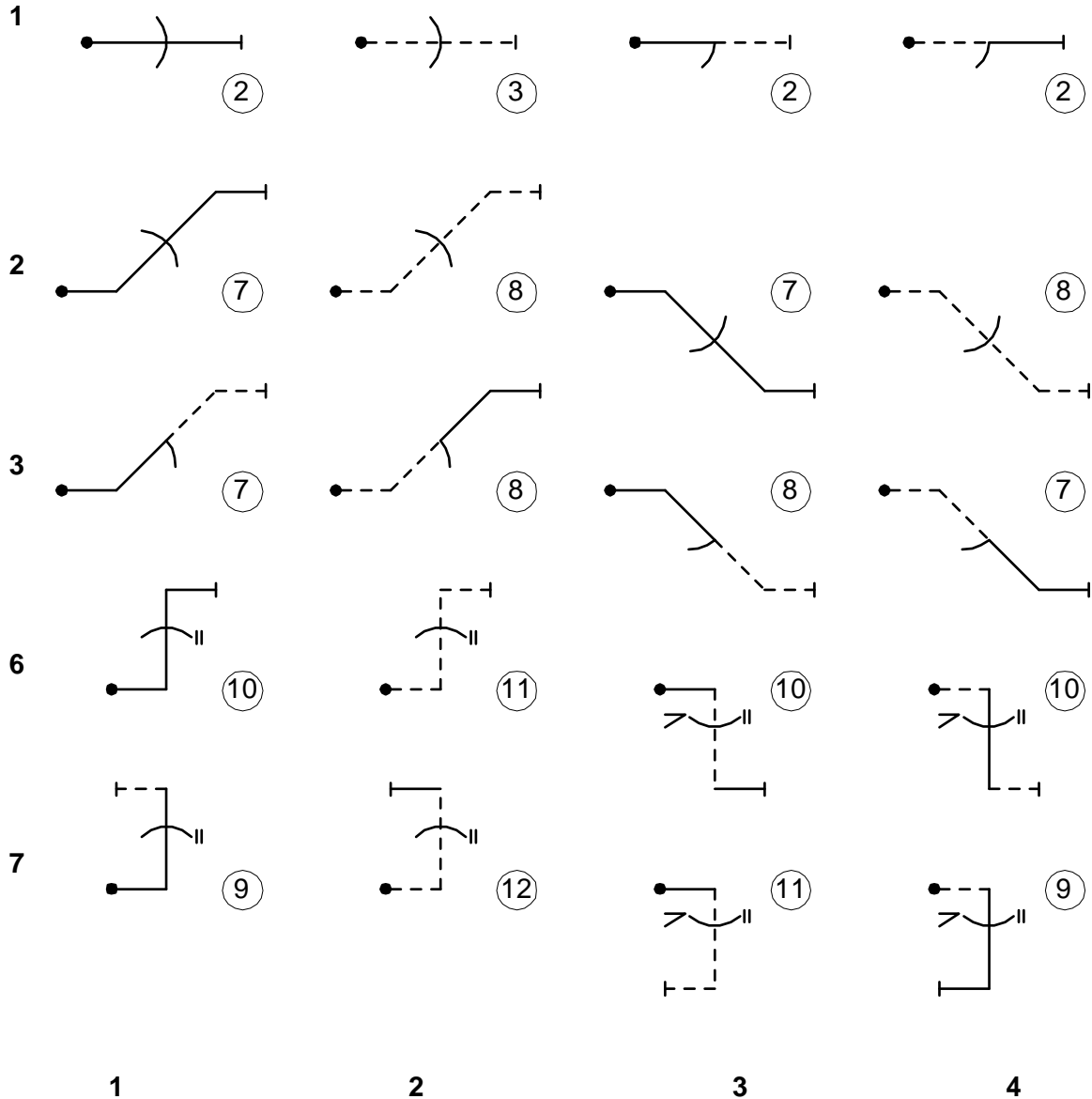

Any of the above figures illustrated with a 360° optional roll sign may be performed without that roll.

1.

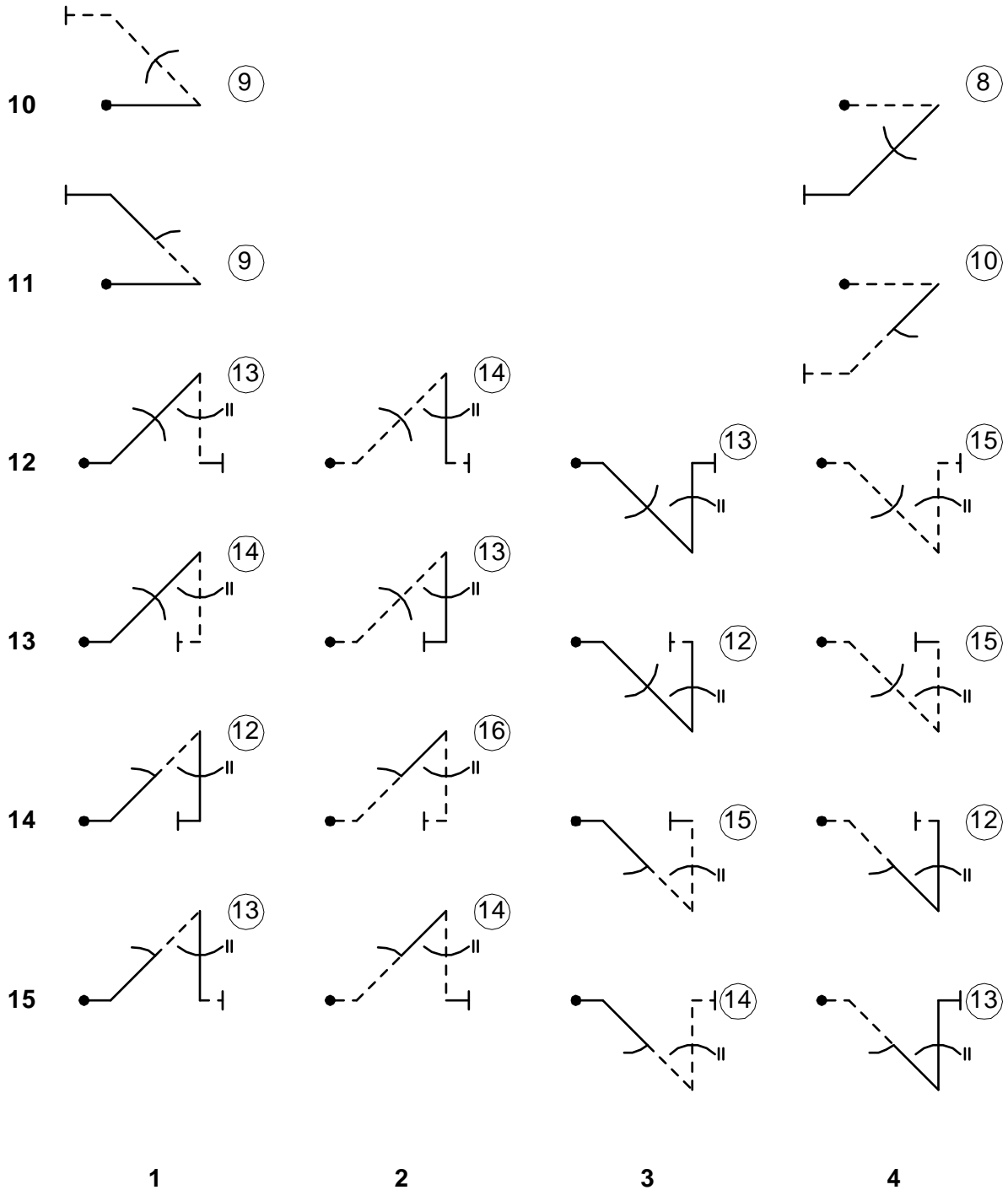

Any of the above figures illustrated with a 360° optional roll sign may be performed without that roll.

1.

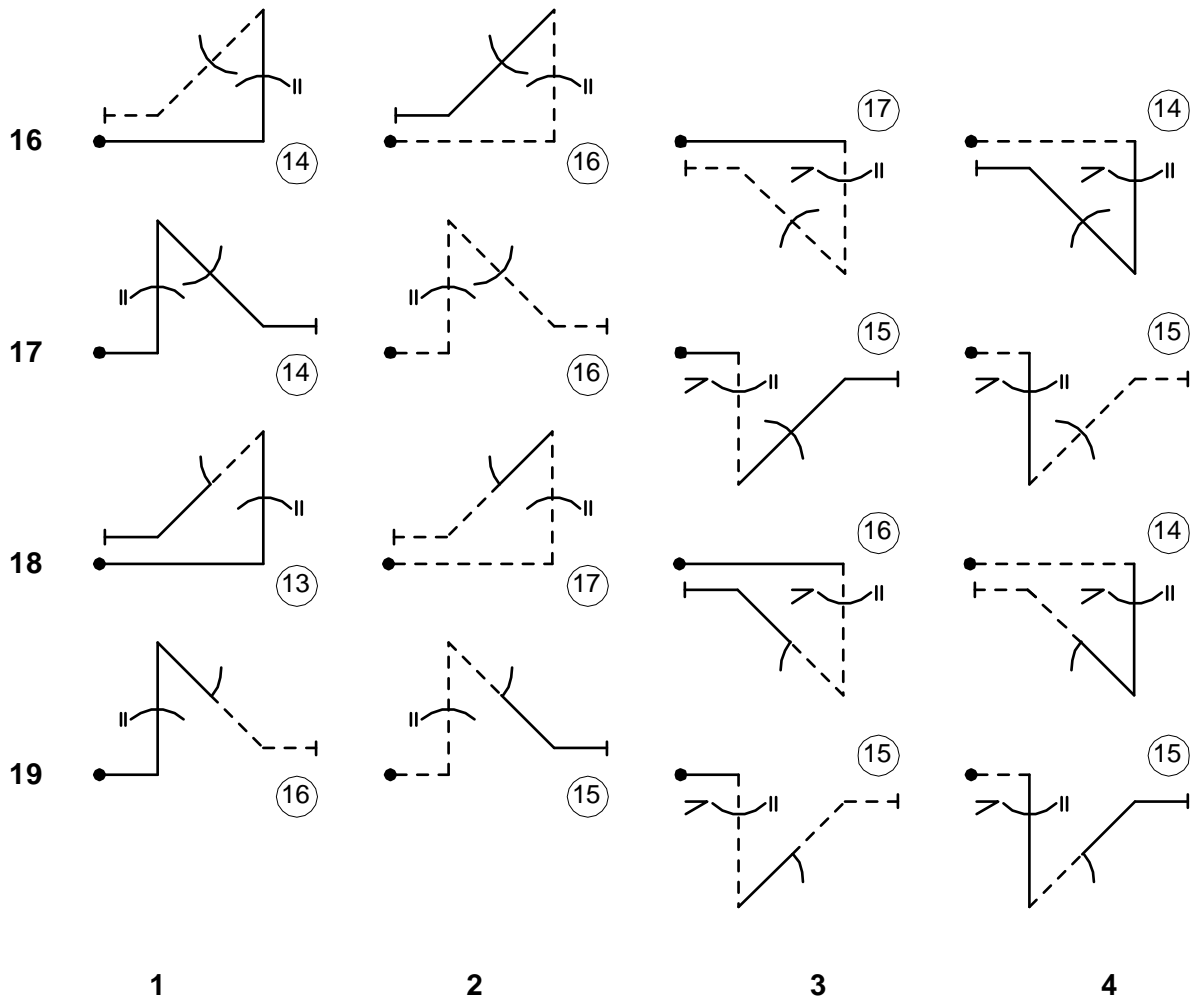

Any of the above figures illustrated with a 360° optional roll sign may be performed without that roll.

2.

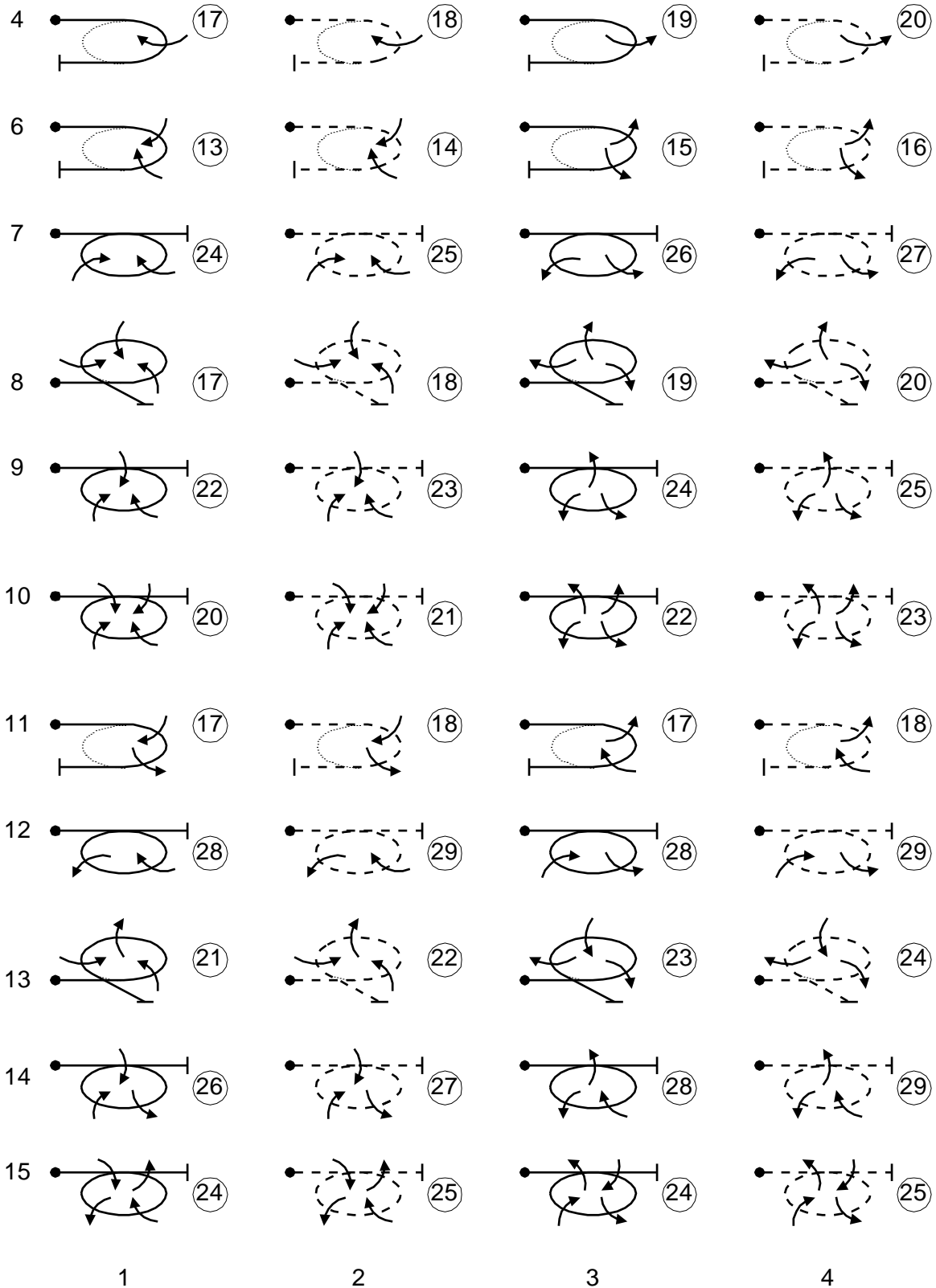

5. STALL TURNS

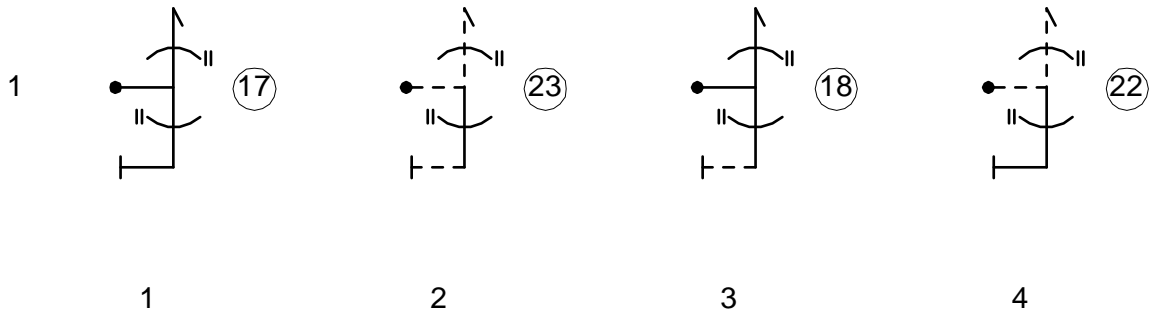

Rolls of 90° and multiples of 90° may be added on the upward or downward vertical lines. The figures may also be flown without rolls.

6. TAIL SLIDES

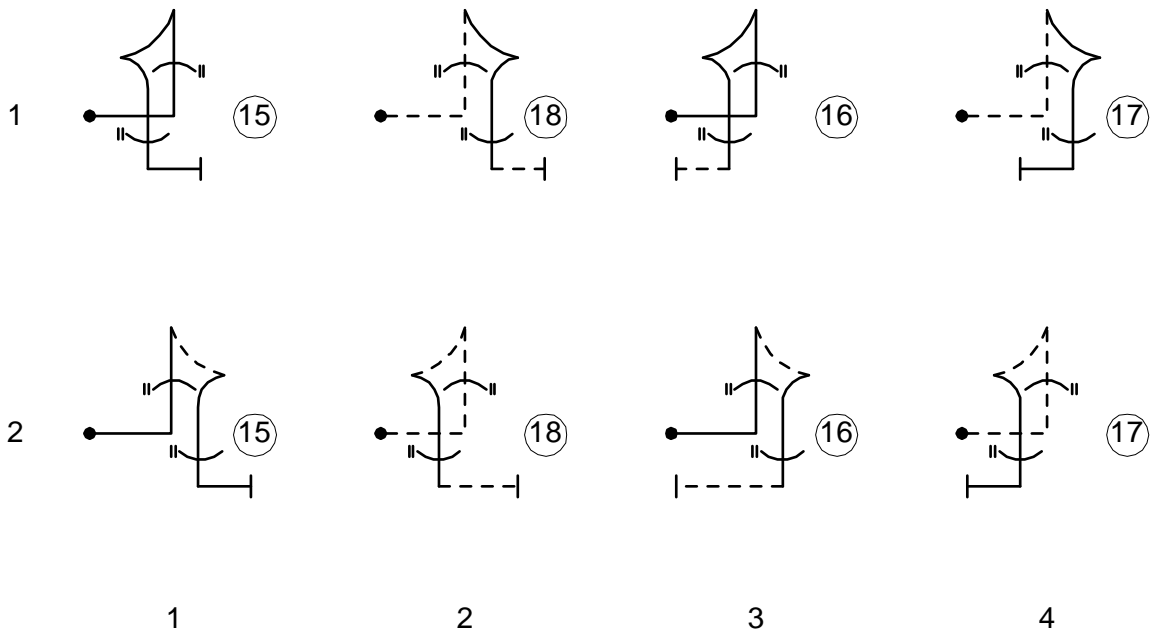

Rolls of 90° and multiples of 90° may be added on the upward or downward vertical lines. The figures may also be flown without rolls. No flick rolls will be allowed in upward vertical lines.

7. LOOPS AND EIGHTS

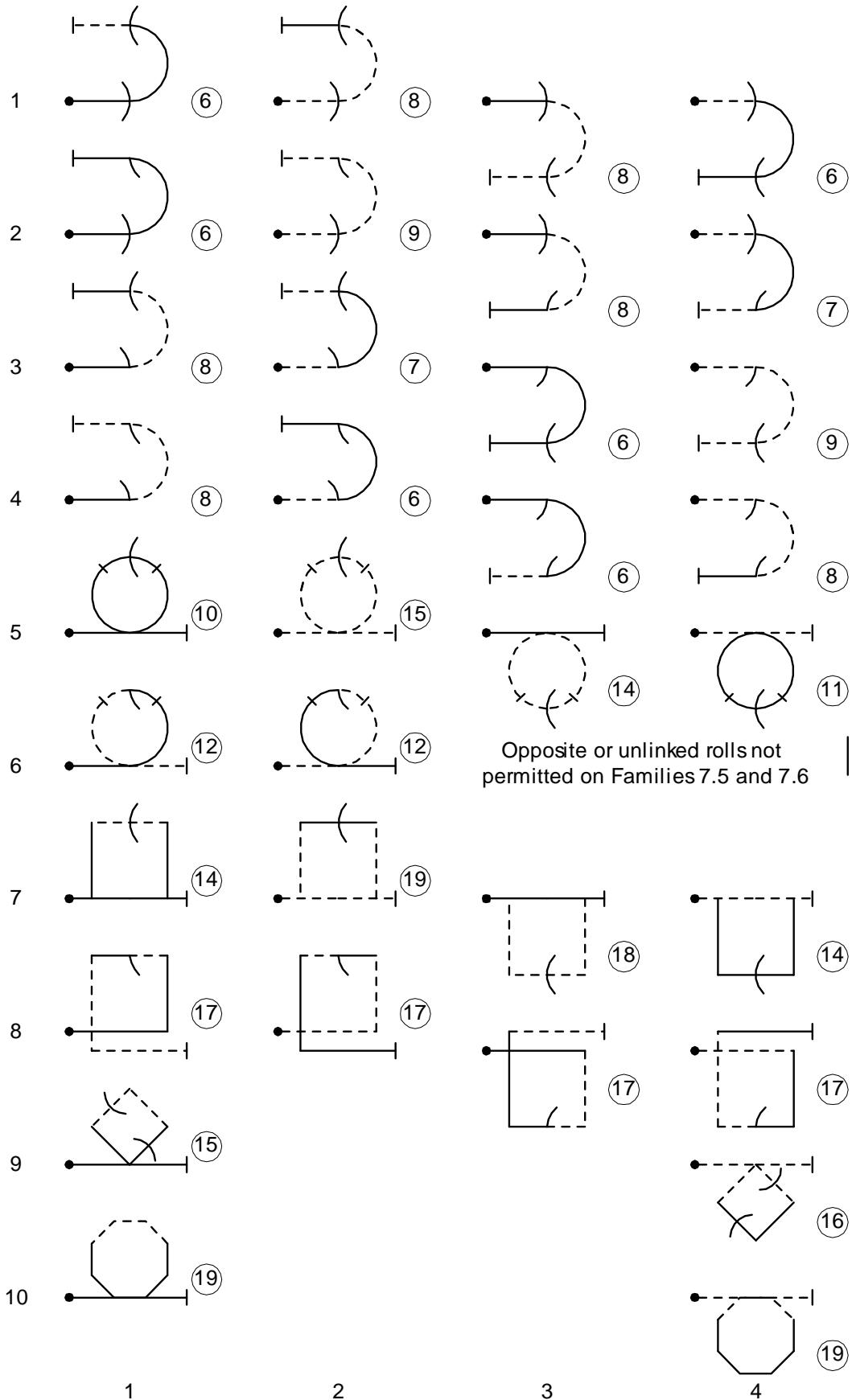

Opposite or unlinked rolls not permitted on Families 7.5 and 7.6



7.

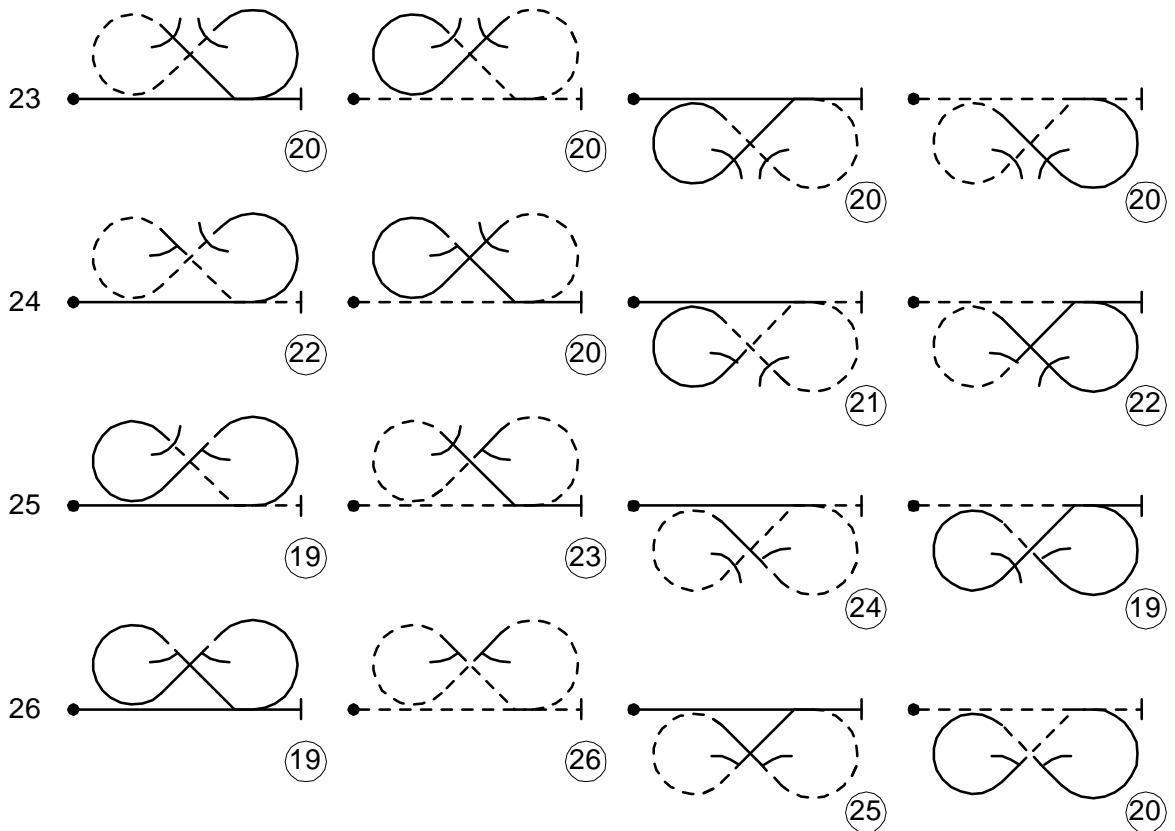
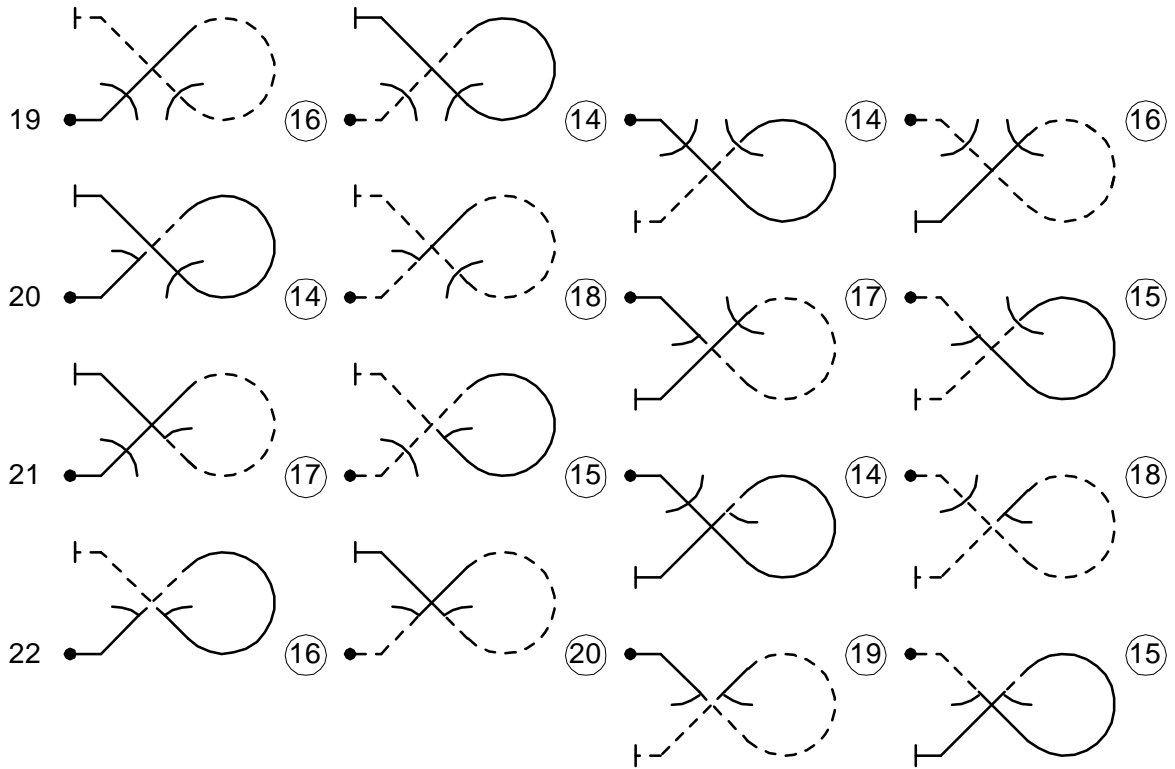

7.

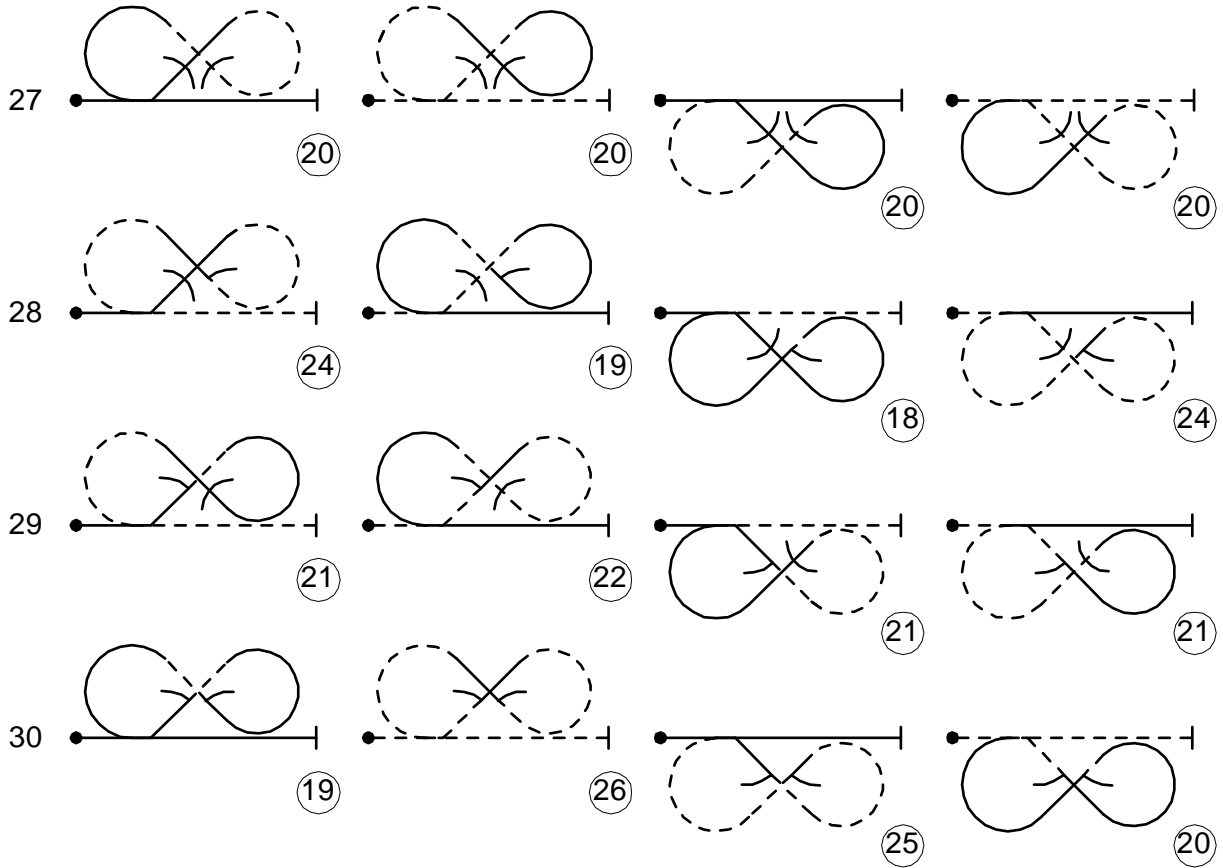

8. COMBINATIONS OF LINES, ANGLES AND LOOPS

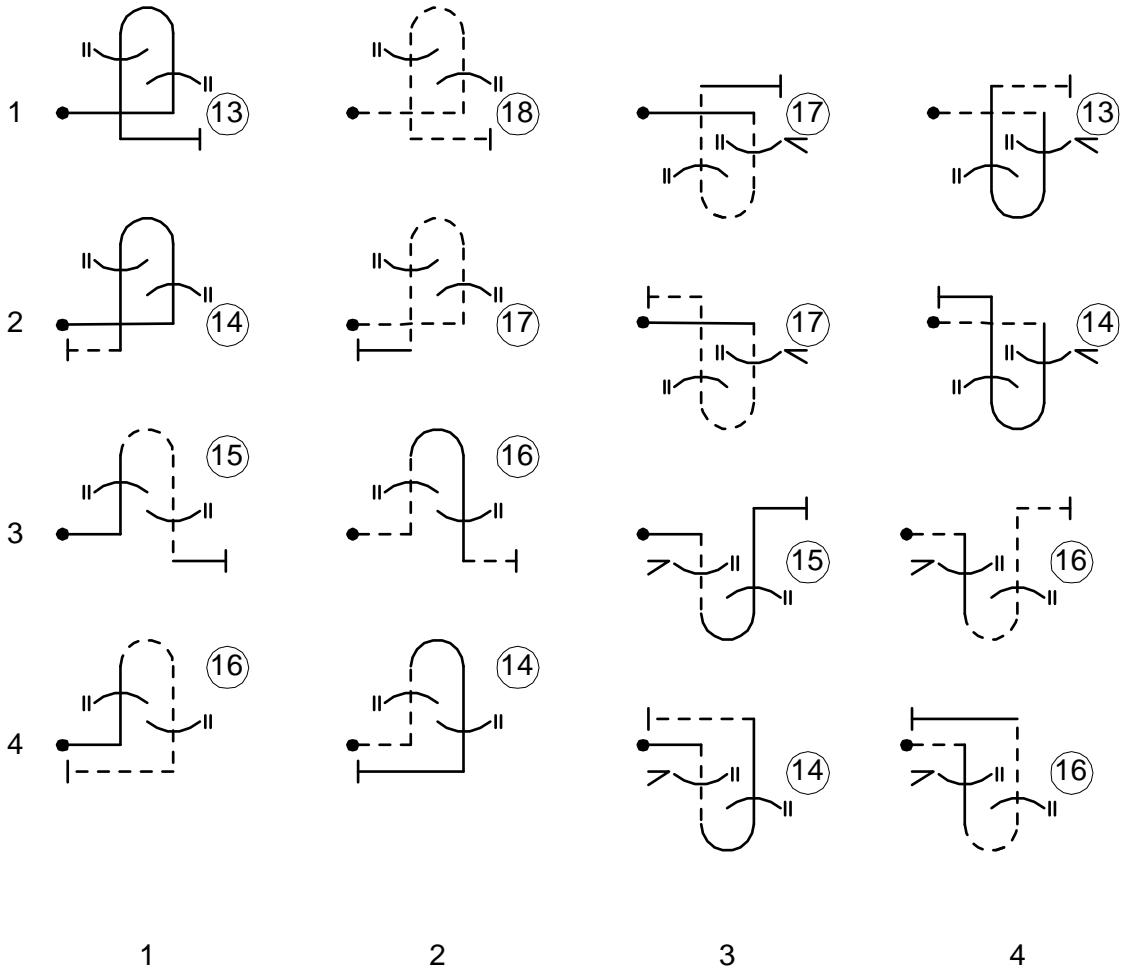

8.

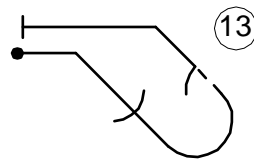
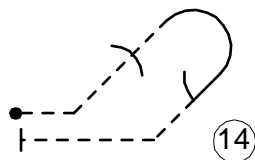
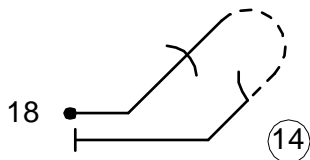
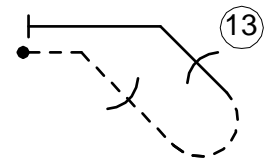
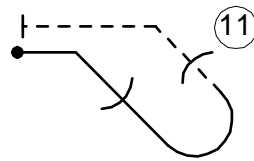
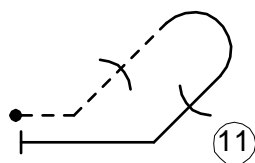
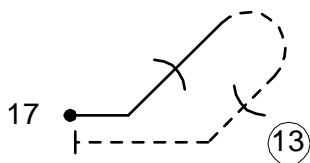
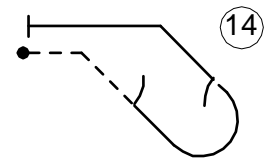
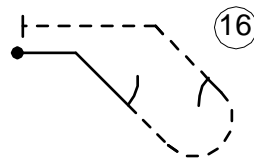
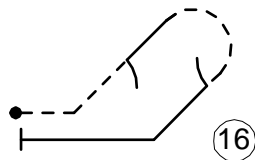
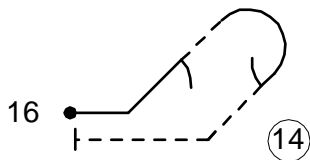
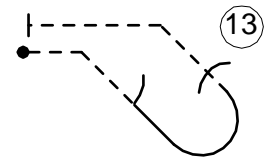
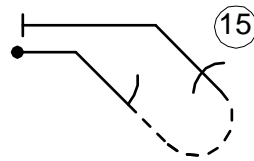
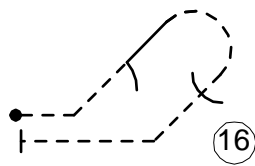
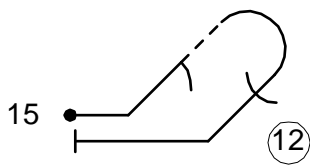
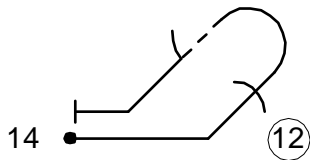
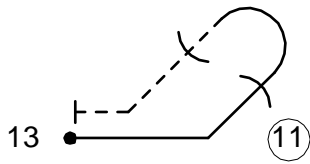

1

2

3

4

8.

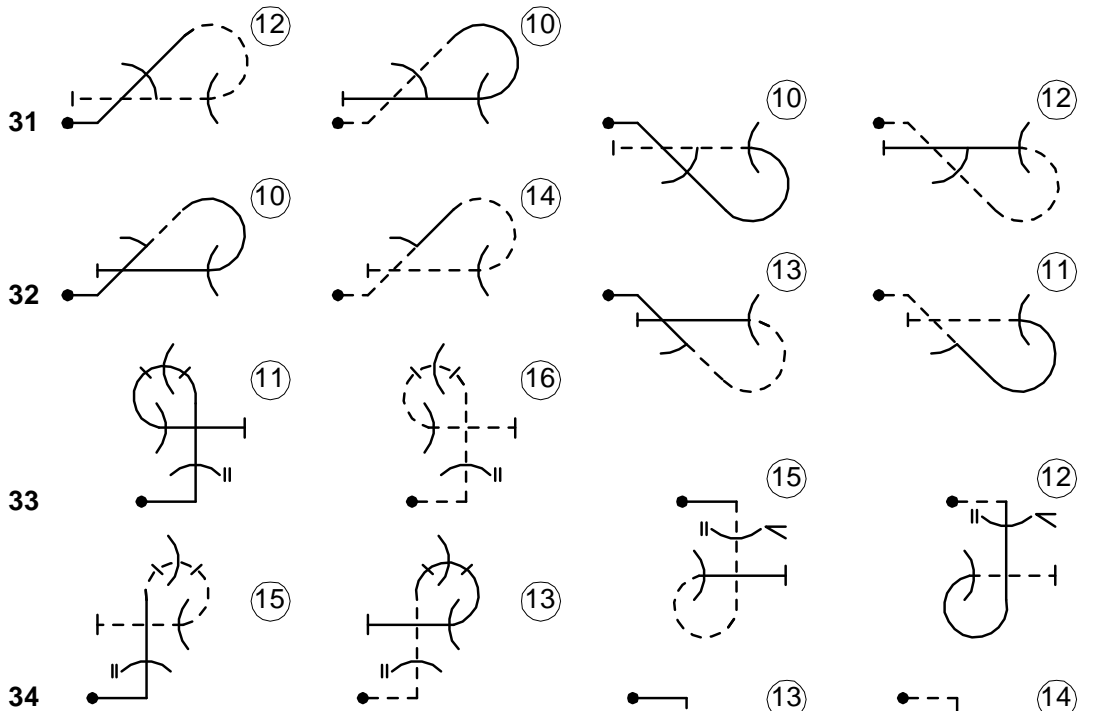

The tops of figures 8.33, 8.34, 8.43, and 8.44 (columns 1 and 2) are not horizontal lines and cannot support opposite or unlinked rolls.

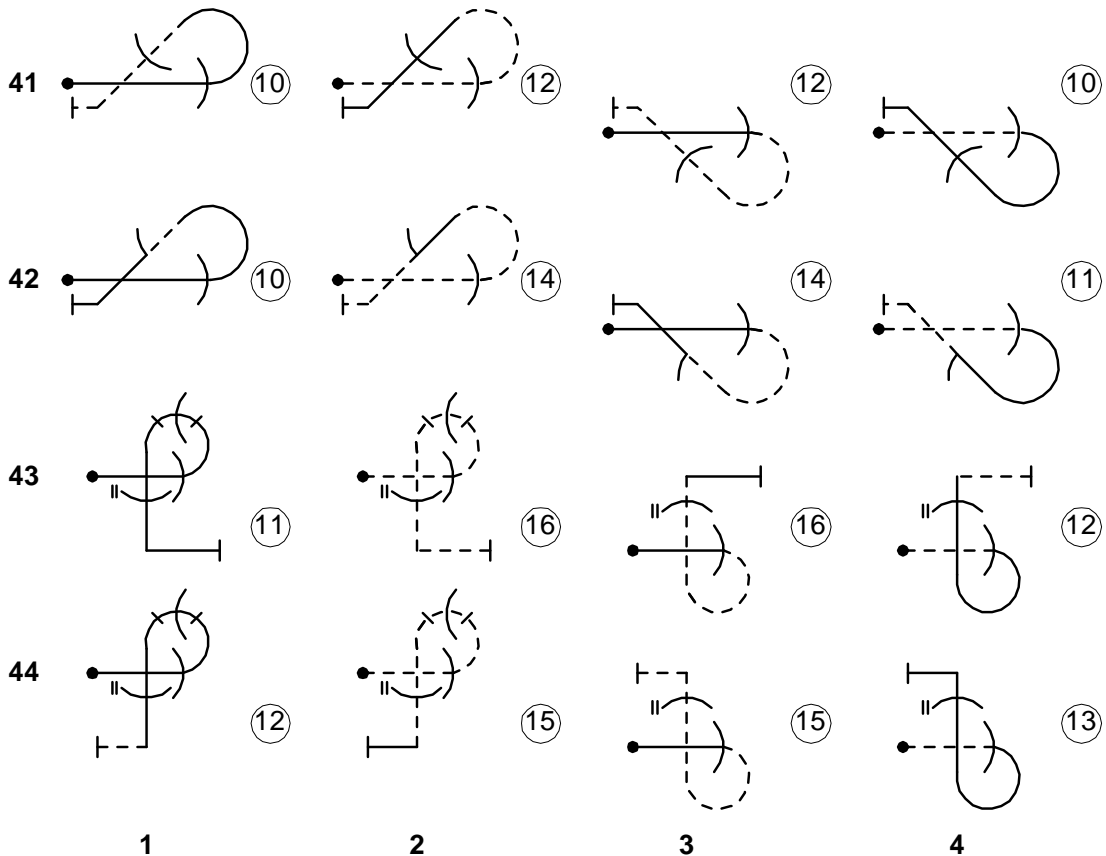

1





2

3

4

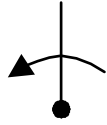

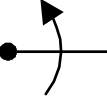
9. ROLLS AND SPINS

9.1		$\frac{1}{4}$	$\frac{1}{2}$	$\frac{3}{4}$	1	$1\frac{1}{4}$	$1\frac{1}{2}$	$1\frac{3}{4}$	2
1		6	8	10	12	14			
2			6		10		12		
3			4		8		10		
4			4		8		10		
5		2	4	6	8				
		1	2	3	4	5	6	7	8



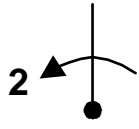
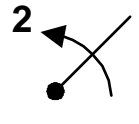
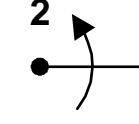
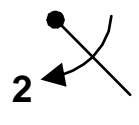
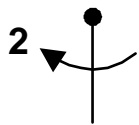

9.2 2-POINT ROLLS

9.2					1	1½	2		
		1	2	3	4	5	6	7	8
1					13				
2					11				
3					9	12			
4					9				
5					9				
		1	2	3	4	5	6	7	8

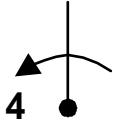
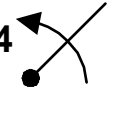
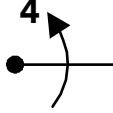
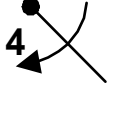

9.4 4-POINT ROLLS







9.4			$\frac{1}{2}$	$\frac{3}{4}$	1	$1\frac{1}{4}$	$1\frac{1}{2}$	$1\frac{3}{4}$	2
		1			9	12	15		
2			7		13				
3			5		11				
4			5		11				
5			5	8					
		1	2	3	4	5	6	7	8

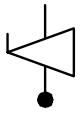
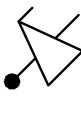

9.8 8-POINT ROLLS

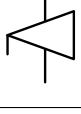
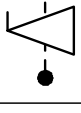
9.8		$\frac{1}{4}$	$\frac{1}{2}$	$\frac{3}{4}$	1	$1\frac{1}{4}$	$1\frac{1}{2}$	$1\frac{3}{4}$	2
1		7	11						
2			9						
3			7		15				
4			7						
5		3	7						
		1	2	3	4	5	6	7	8

9.9 POSITIVE FLICK ROLLS

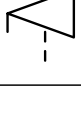
9.9			$\frac{1}{2}$	$\frac{3}{4}$	1	$1\frac{1}{4}$	$1\frac{1}{2}$	$1\frac{3}{4}$	2
1			15	15	15				
2			13		13				
3			11		11		14		
4			11		11		14		
5			11	11	11				
6			17	17	17				
7			15		15				
8			13		13				
9			13		13				
10			13	13	13				
		1	2	3	4	5	6	7	8







9.10 NEGATIVE FLICK ROLLS





9.10			1/2	3/4	1	1 1/4	1 1/2	1 3/4	2
1			17	17	17				
2			15		15				
3			13		13		16		
4			13		13				
5			13	13	13				
6			19	19	19				
7			17		17				
8			15		15				
9			15		15				
10			15	15	15				
		1	2	3	4	5	6	7	8

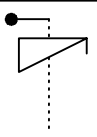
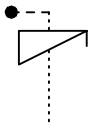

9.11 POSITIVE SPINS

									
					1	1¼	1½	1¾	2
1		Upright Entry Line			5	4	3		
2		Inverted Entry Line			6		4		
					4	5	6	7	8

9.12 NEGATIVE SPINS

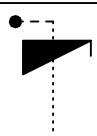
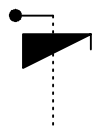
									
					1	1¼	1½	1¾	2
1		Inverted Entry Line			7	6	5		
2		Upright Entry Line			8		6		
					4	5	6	7	8



APPENDIX 4 TO CIVA REGULATIONS (PART ONE)

CODE OF PRACTICE FOR THE CHIEF JUDGE AND BOARD OF JUDGES AT WORLD AND CONTINENTAL AEROBATIC CHAMPIONSHIPS

Chief Judge

1. The Chief Judge's primary concern should be the accurate and fair judging of the competition flights, including the monitoring of flights for zero marks and penalties. He should place his expertise at the disposal of the Board of Judges, and coordinate and guide their work.
2. The Chief Judge oversees administrative matters (correctness of paperwork, recording of penalties, etc.) but should be provided with a small group of special assistants who will perform at least the following tasks under his supervision: (i) calling the manoeuvres and recording the notes of the Chief Judge, to whatever extent he requires; (ii) processing and expediting the flow of paperwork; (iii) receiving and recording the calls of the Line Judges; (iv) handling all other radio communications. One of his assistants should assist in monitoring the zero marks and penalties awarded by the Judges after each flight.
3. The Chief Judge should record his marks and comments, as an aide-memoire, on a score sheet which he retains for his own future reference. The official recording of penalties will be on a separate sheet which is later available for the contestant to check.
4. The Chief Judge must hold seminars with the Judges, at least one of which will be with Team Managers or other team representatives present (CIVA 1.1.6.2.). He should give guidance to the Judges as to the current Judging Criteria and rules for judging, on which he should conduct 'question and answer' sessions with the aid of the President of the Judging Sub-Committee.
5. The Chief Judge will hold other routine evaluation meetings with the Judges during the contest (CIVA 1.1.6.2.), and before it begins he must hold practice sessions on the judging line during the contestants' training flights (see 6 below). He should insure that the Code of Practice is understood and operates smoothly, and establish a good working relationship between teams of Judges and Assistants, Timekeepers, and other helpers.
6. The Chief Judge is responsible for ensuring that there is enough time between flights for the judging to be unhurried: he should control (by radio) the flow from one contestant to the next.
7. At the end of each flight, the Chief Judge should ascertain whether any of the Judges has recorded a zero mark or height penalty. A suitable method should be arranged for individual Judges to call such matters to the Chief Judge's attention as soon as the flight ends.
8. In the event of a difference of opinion between the Judges concerning a zero mark or height penalty, the Chief Judge must call for a discussion as soon as possible after it is brought to his attention (CIVA 2.4.8.). The official video shall be available to assist in these discussions (CIVA 2.1.6.).
9. In case of a vote among the Judges on the question of penalisation, the Judge of the same nationality as the pilot shall abstain from voting (CIVA 2.1.1.4.).
10. The awarding of zero marks is determined by majority, with the Chief Judge having a casting vote (Sporting Code, Section 6, 2.1.16.). It should be noted that when a Judge's vote is over-ruled, upward correction of a zero must be to AT LEAST the mark nearest zero given by any other Judge, or the Judge's reserve mark. Each Judge must correct and sign his own score sheet.
11. The awarding of penalties for infringements of upper and lower height limitations is decided by majority vote of the Judges. In case the required simple majority could not rise from a vote within the Board of



Judges, the Chief Judge shall have the casting vote; a two-thirds majority being required for the penalty of disqualification (CIVA 1.4.4.3., 2.3.2.2.).

12. The Chief Judge shall indicate to the Panel of Judges when they must watch and mark a programme (CIVA 1.4.6.1.), and when they must cease because the contestant has exceeded his time limit (CIVA 2.3.1.1.). He should also note which figures should receive a zero because they have been started behind the Judges (2.1.4.3.).

13. Where the awarding of penalties for improper wing-rocking is concerned, to check and decide on this is the responsibility of the Chief Judge assisted by the timekeepers (CIVA 2.3.1.3.).

14. After the first competitor's flight in Programme 4, the Chief Judge will hold a mandatory meeting of all judges. The marks of the judges will be compared to establish a judging standard for the programme.

15. Judges evaluation by flight programme will be conducted by the International Jury using the software programme approved by CIVA. The Chief Judge will receive a complete analysis of all Judges from the International Jury. Individual Judges will receive only their own evaluation.

The Judges

1. It is required that all Judges use an experienced Judge's Assistant from their own team, together with a writer who may be supplied as a member of the Judge's team or, on request, by the organisers (subject to availability).

2. All Judges should obtain and study copies of all contestants' Free Programmes before flying of the programme is started.

3. A Judge may only reconsider his marks so long as his score sheet is still in his possession. After it is signed and handed in, it comes under the jurisdiction of the International Jury.

4. The preliminary flights by non-competing pilots (CIVA 1.1.8.) will be marked exactly as if they were competitors; bearing in mind that the purpose of these flights is so that the first competing pilot who follows them shall not be penalised by receiving an unduly low 'anchor' mark.

5. It is strongly recommended that the Judges record remarks on the score sheets.

6. Judges shall not keep or make reference to a flight order sheet, whilst on the judging line.

APPENDIX 5 TO CIVA REGULATIONS (PART ONE)

THE AEROBATIC PERFORMANCE ZONE

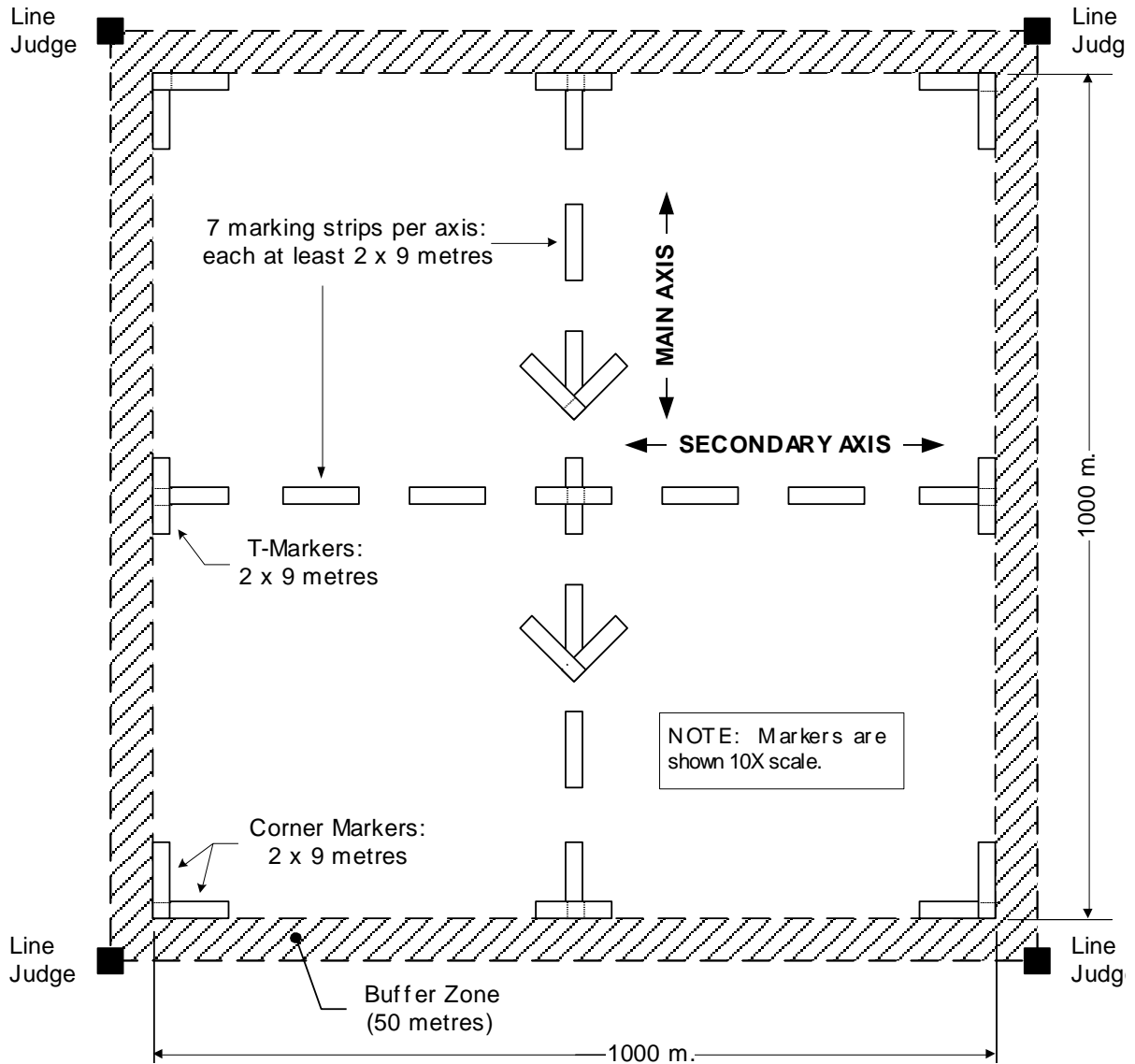



APPENDIX 6 TO CIVA REGULATIONS (PART ONE)

JUDGES PERFORMANCE FACTORS

The JPF system uses the deviation of each judge's TBLP'ed scores from the mean value of all judges. This is transformed into an easily recognizable Judge Performance Factor.

Judges give marks from 0 to 10 and this scale is the basis of the measurement of his performance. Therefore, for one Judge Y, all his TBLP scores are recalculated to a mean score. This means for a 500 K sequence (including positioning) a TBLP score of 4,000 points for Pilot A is equivalent to a mean score of 8.0. If the mean value of all Judges on Pilot A is 3,750 points, or a mean score of 7.5, then Judge Y is high by 0.5 on Pilot A.

The deviation of 0.5 is now squared to make large excursions more pronounced. The result would be $0.5 \times 0.5 = 0.25$. This procedure is done for all pilots and all scores from Judge Y. All squared deviations are added up and are divided by the number of pilots to get the mean of the squared deviations.

Example: Judge Y, 500 K sequence = 5,000 points maximum

Pilot	Judge Y Points/Score	Mean All Judges Points/Score	Deviation	Square Deviation
A	4,000 / 8.0	3,750 / 7.5	+0.5	+0.25
B	3,000 / 6.0	3,500 / 7.0	+1.0	+1.00
C	3,500 / 7.0	3,500 / 7.0	0.0	0.00
D	4,250 / 8.5	4,400 / 8.8	-0.3	+0.09
E	2,800 / 5.6	3,000 / 6.0	-0.4	+0.16
F	3,700 / 7.4	3,500 / 7.0	+0.4	+0.16

$$\sum 1.66$$

The mean value of the squared deviations = $1.66 \div 6 = 0.277$.

To obtain an easily recognizable number, the value is multiplied by 100. The JPF in this example is **27.7** ... not a very good judge rating. This procedure is repeated for all judges for this sequence.

When this program was approved, CIVA adopted the following ratings:

JPF	0 to 5	Excellent
JPF	>5 to 10	Good
JPF	>10 to 15	Marginal
JPF	>15	Bad

To understand these number ratings, the background of these numbers must be recognized.

EXCELLENT	means the judging deviated not more than 0.22 points from the mean value of all judges.
GOOD	means more than 0.22 points and less than 0.316 points deviation from the mean value of all judges.
MARGINAL	means more than 0.316 and less than 0.387 points deviation.
BAD	means more than 0.387 points deviation.



CIVA REGULATIONS (PART ONE)
UNLIMITED CATEGORY COMPETITIONS
RECORD OF AMENDMENTS

Amendment Number	Date Inserted
1	1 January 1989
2	1 January 1990
3	1 January 1991
4	1 January 1992
5	1 January 1993
6	1 January 1994
7	1 January 1995
8	1 January 1996
9	1 January 1997
10	1 January 1998
11	1 January 1999
12	1 January 2000